

Compliments Eckhard Kull

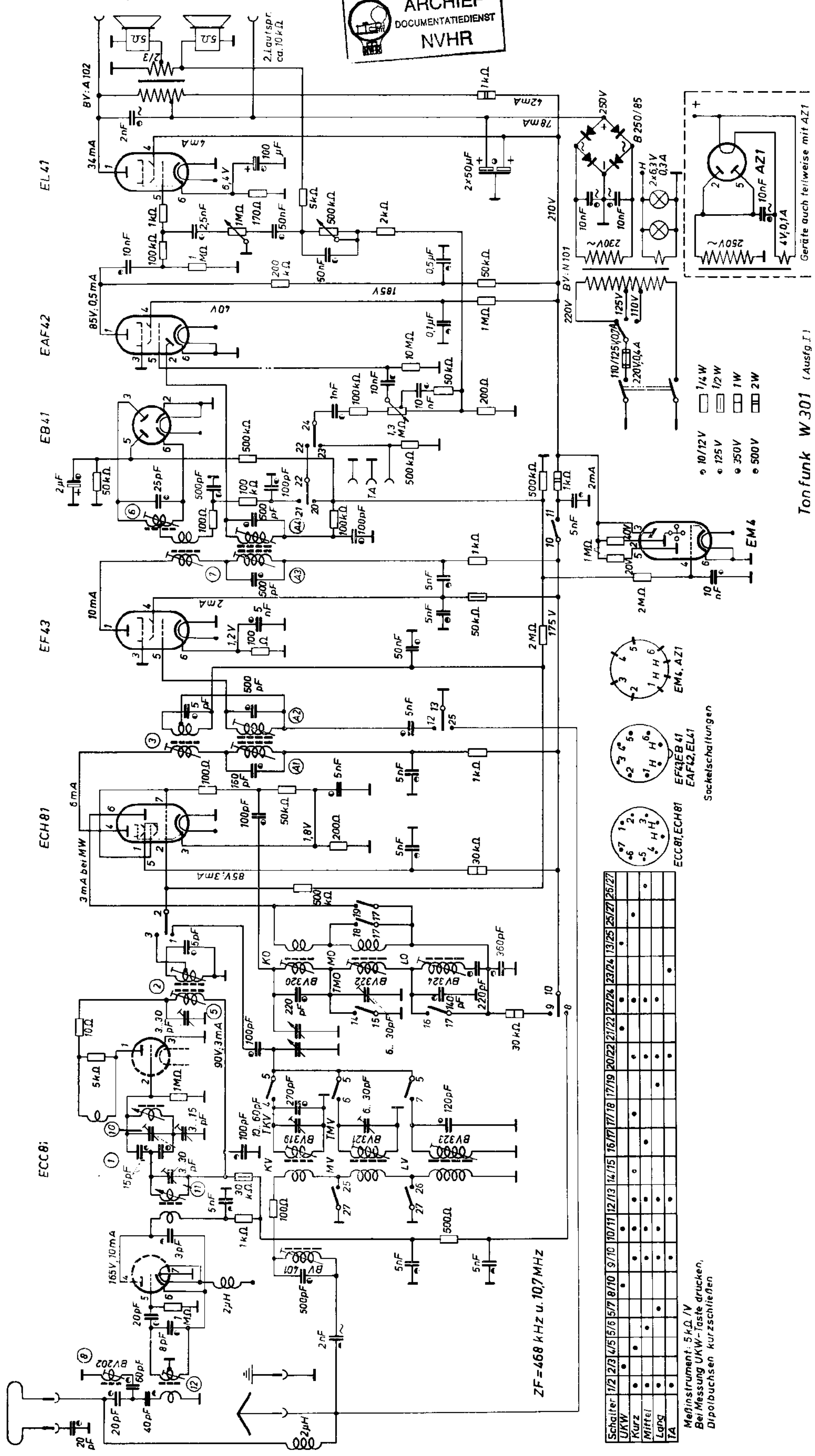

Schalter	1/2	2/3	4/5	5/6	5/7	8/10	9/10	10/11	12/13	14/15	16/17	17/18	17/19	20/22	21/22	22/24	23/24	13/25	25/27	26/27
UKW	•	•	•	•	•	•	•	•	•	•	•	•	•	•	•	•	•	•	•	•
Kurz	•	•	•	•	•	•	•	•	•	•	•	•	•	•	•	•	•	•	•	•
Mittel	•	•	•	•	•	•	•	•	•	•	•	•	•	•	•	•	•	•	•	•
Lang	•	•	•	•	•	•	•	•	•	•	•	•	•	•	•	•	•	•	•	•
TA	•	•	•	•	•	•	•	•	•	•	•	•	•	•	•	•	•	•	•	•

Messinstrument: 5kΩ/V
Bei Messung UKW-Taste drücken,
Dipolbuchsen kurzschließen

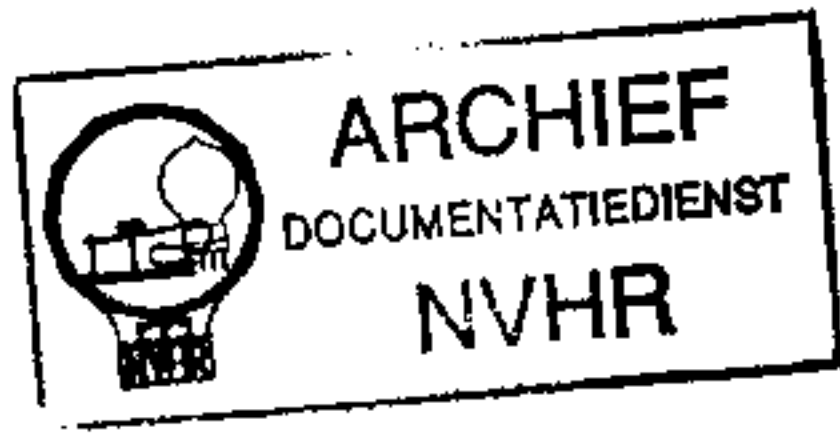
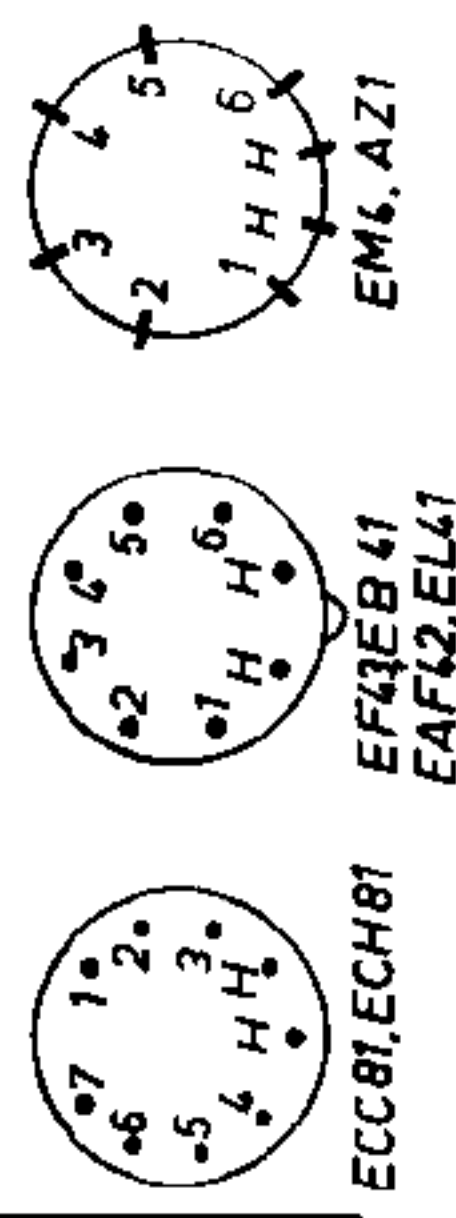

Sockelschaltungen

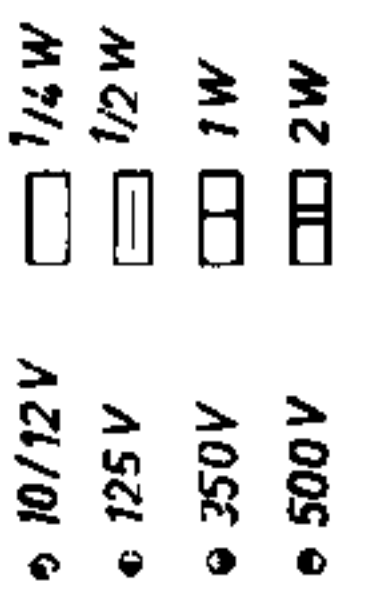

Tonfunk W 301 (Ausfg. I.)

Geräte auch teilweise mit AZ1



VIOLETTA W 301/601/901

Abgleich sämtlicher Wellenbereiche
siehe „Allgemeine Abgleichanweisungen“

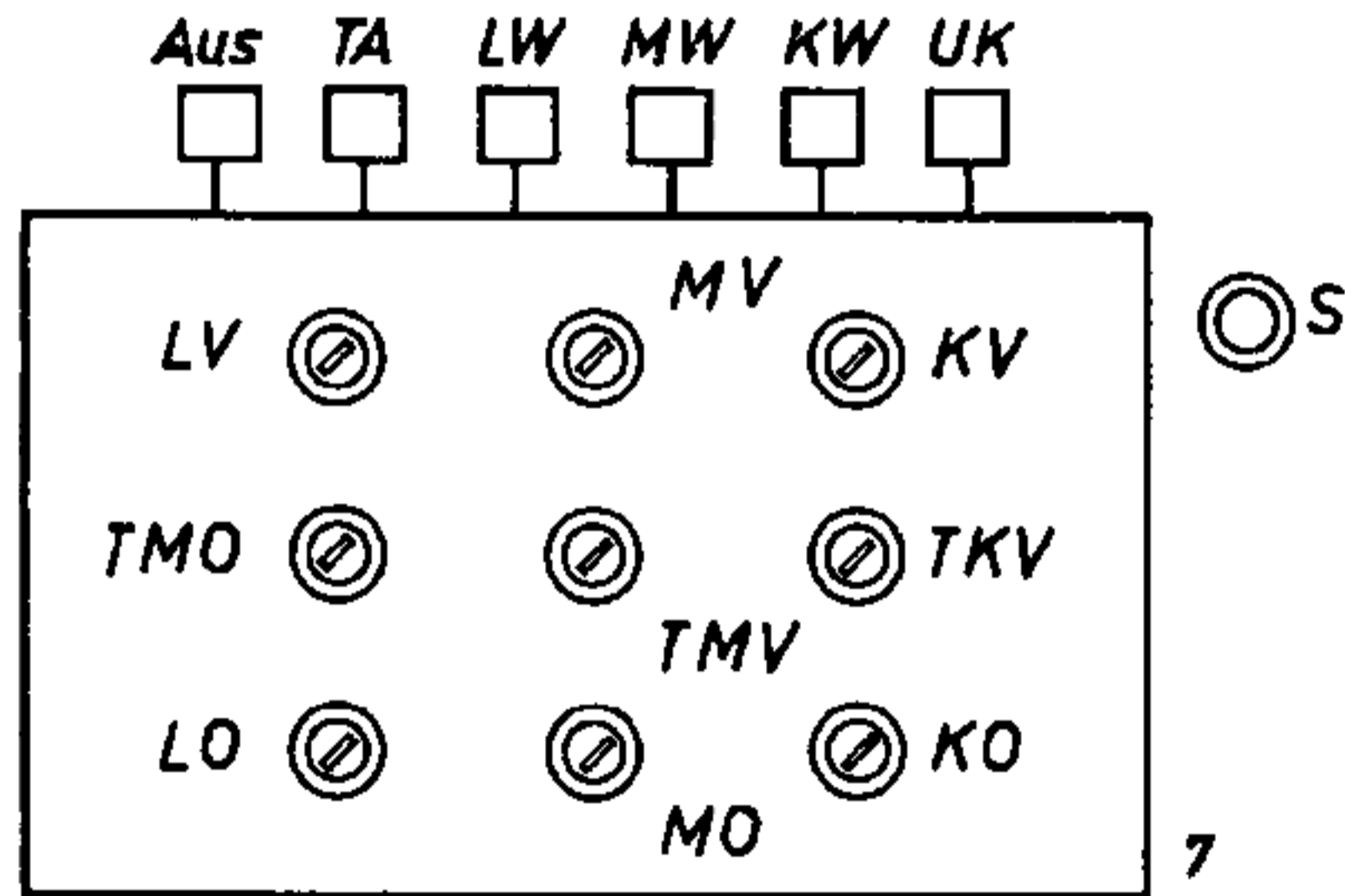
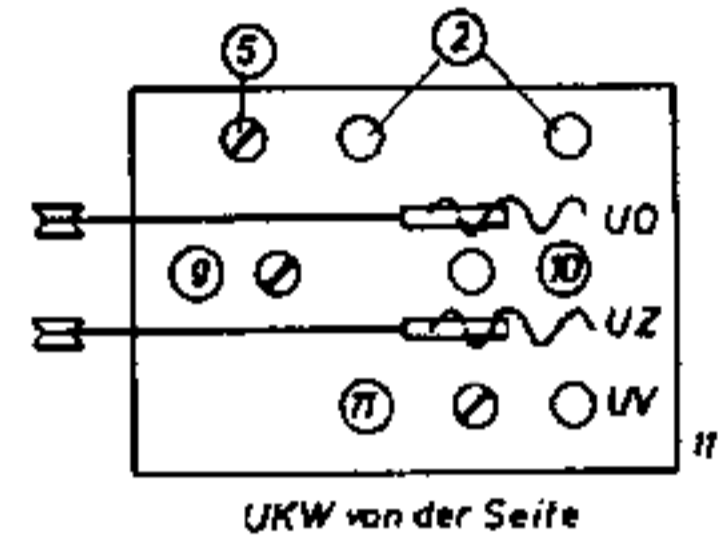
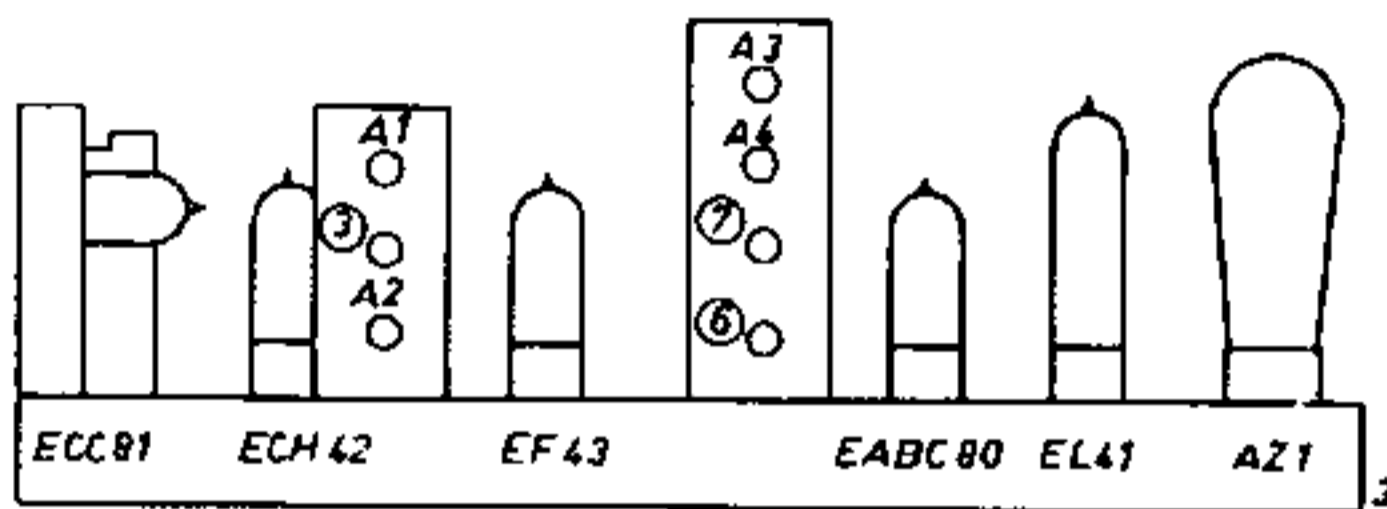

Spulensatz von unten

Anmerkungen: