

Compliments Eckhard Kull

Dipol 240Ω

### PCC 88 Rö 1

### PCF 80 Rö 2

### EF 80 Rö 3

### EF 80 Rö 4

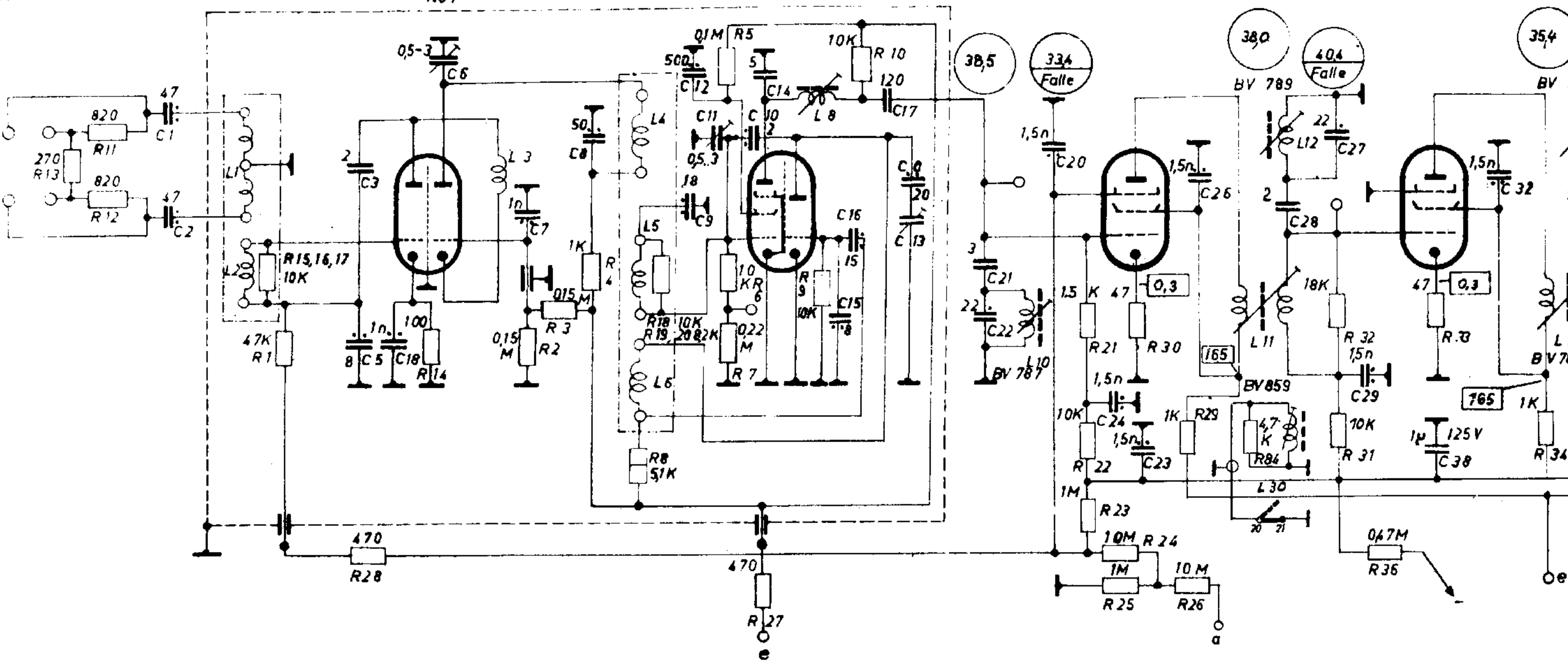

### EF 80 Rö 8

### PCL 82 Rö 9

### ECC 81 Rö 10

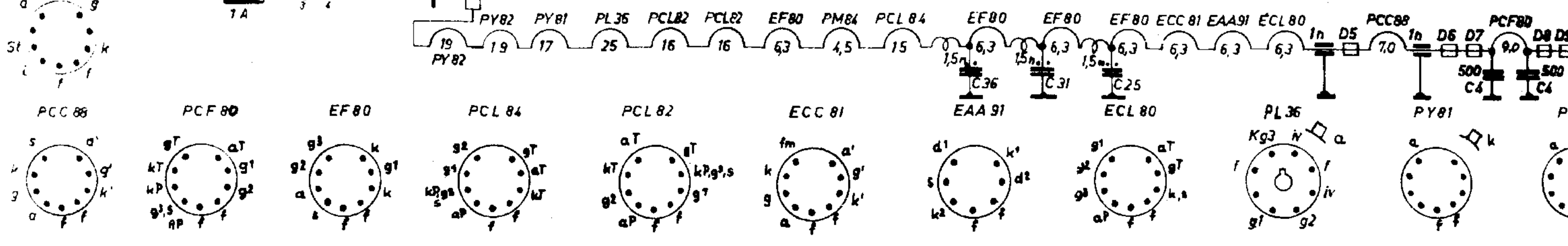
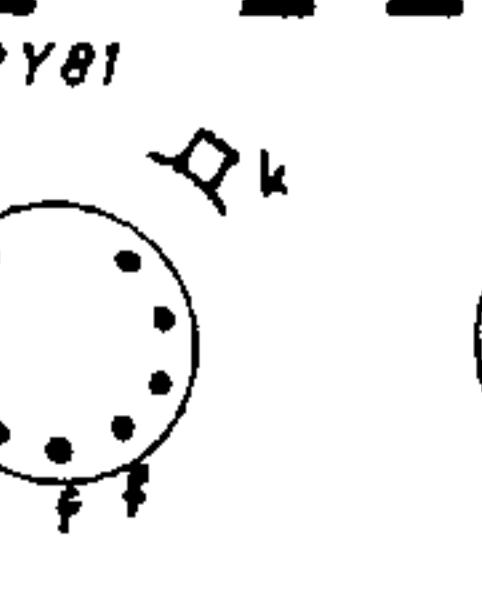
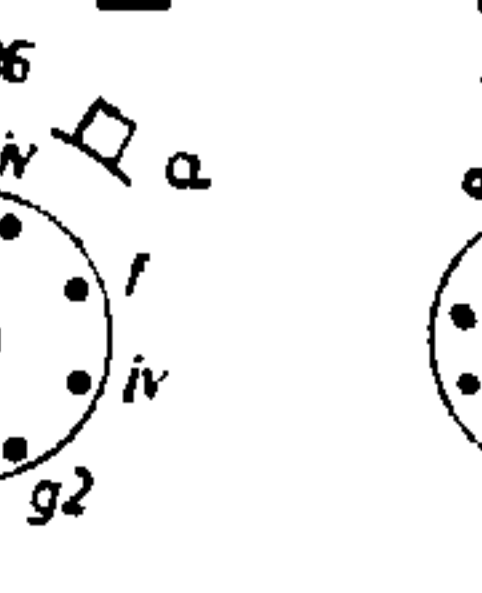
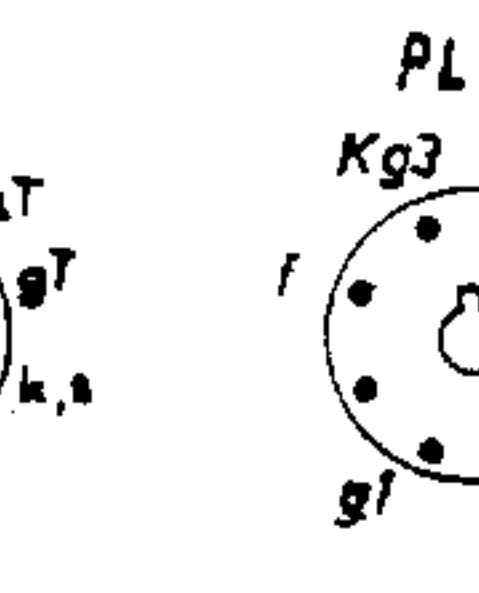
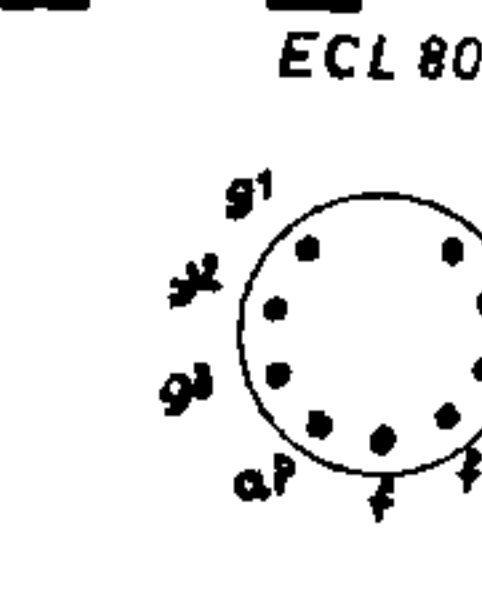
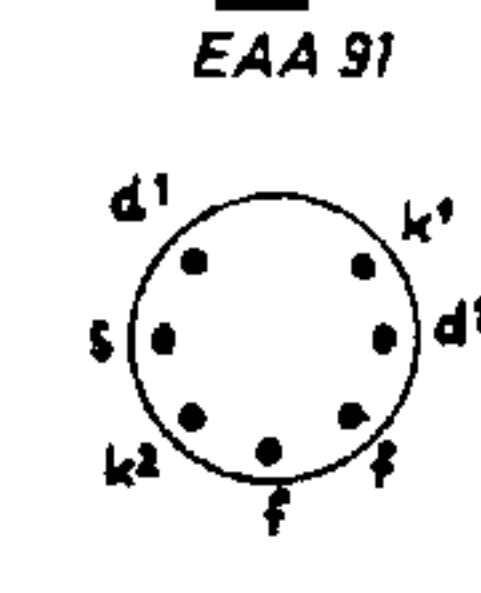
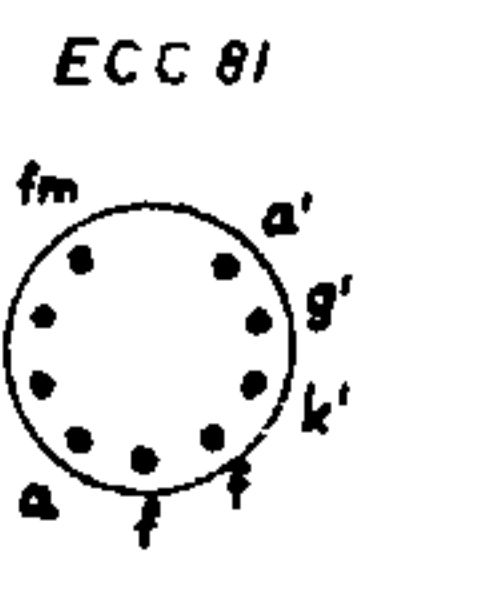
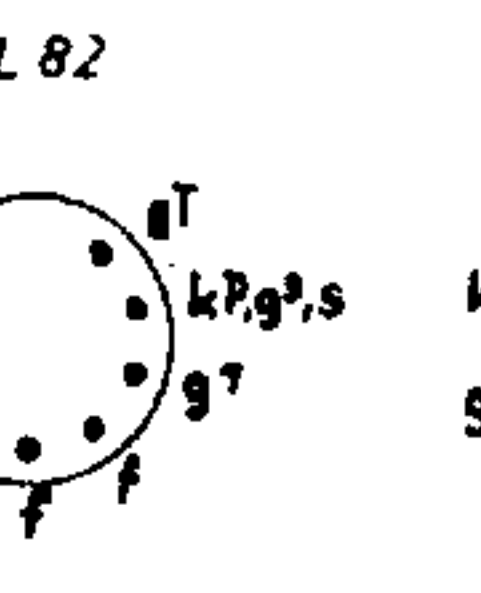
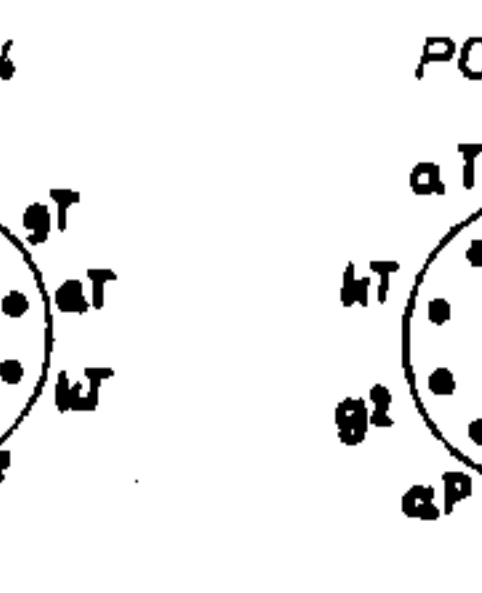
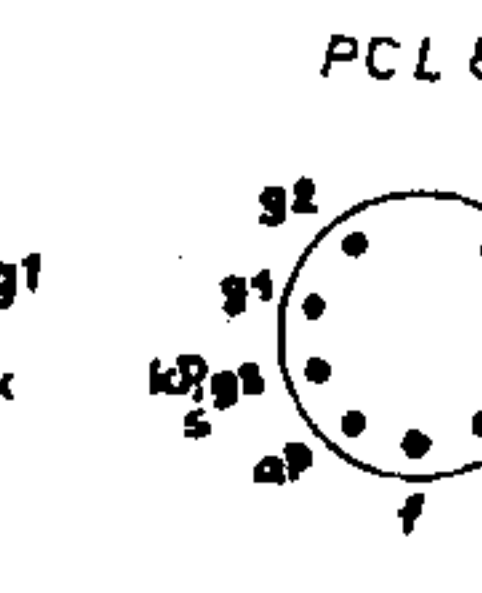
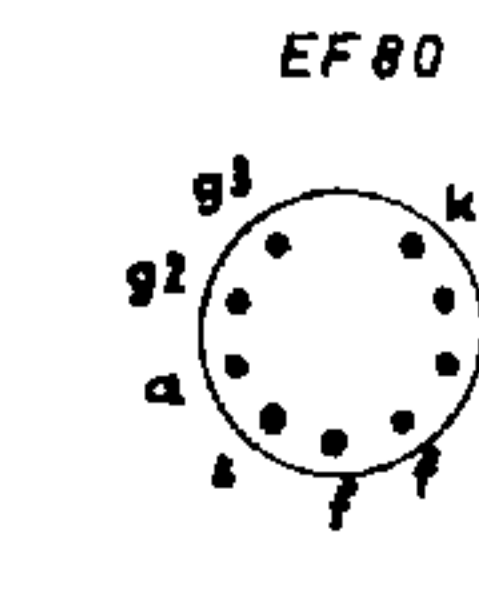
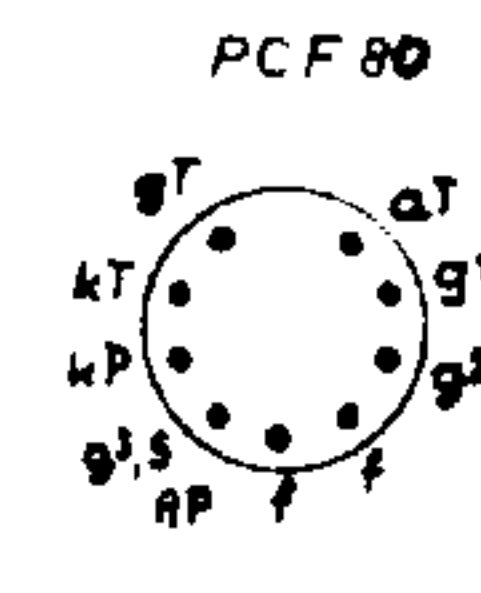
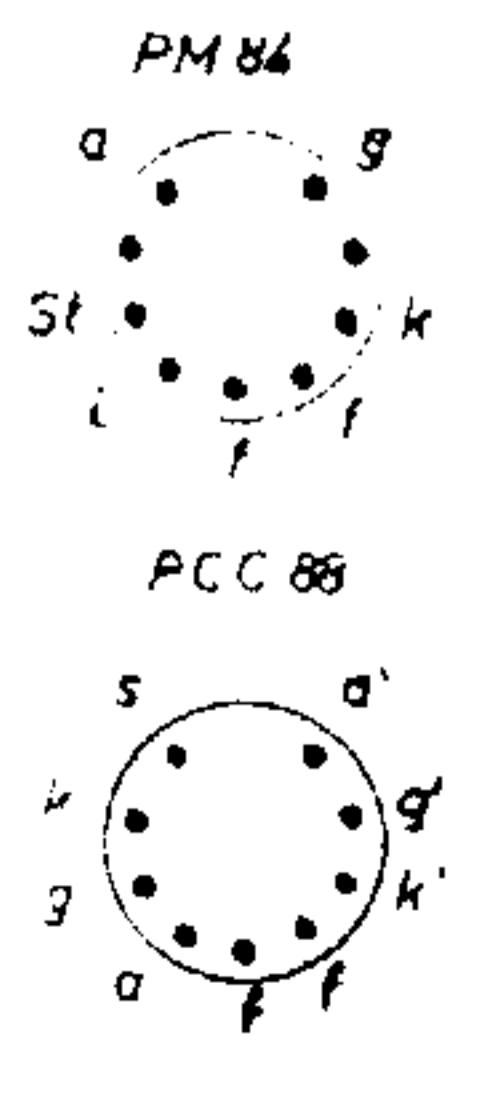
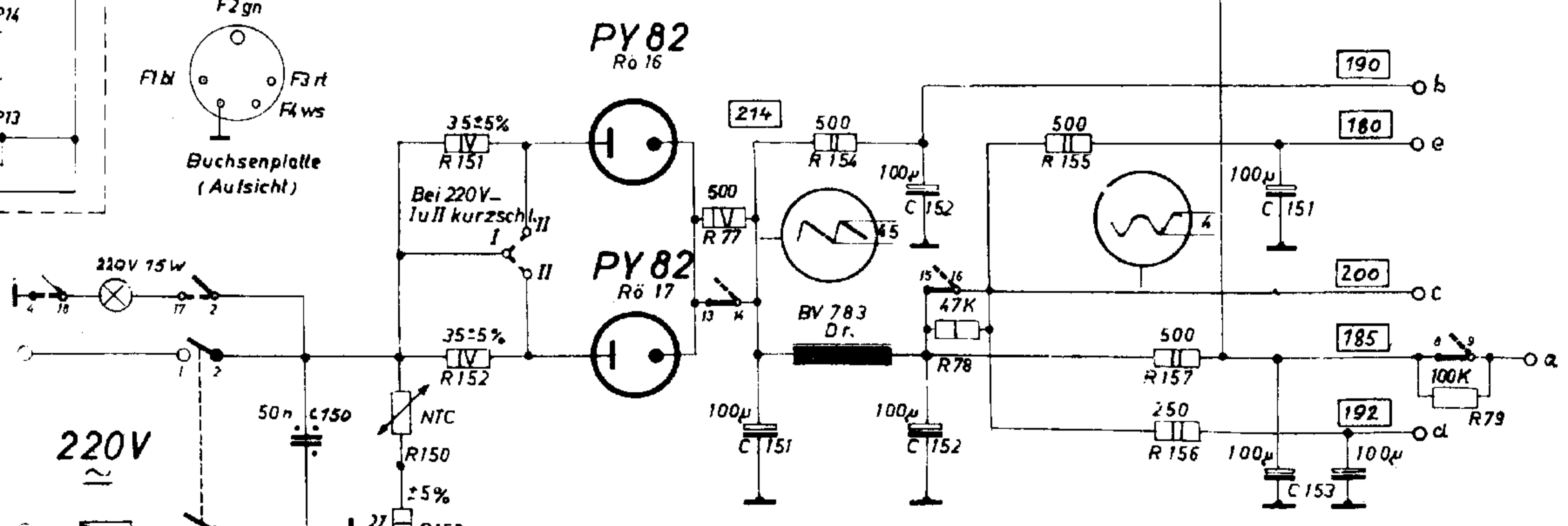
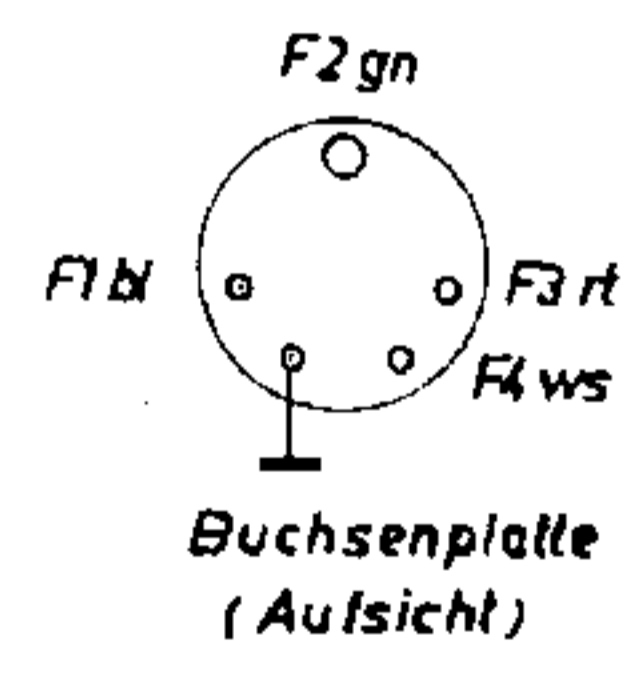
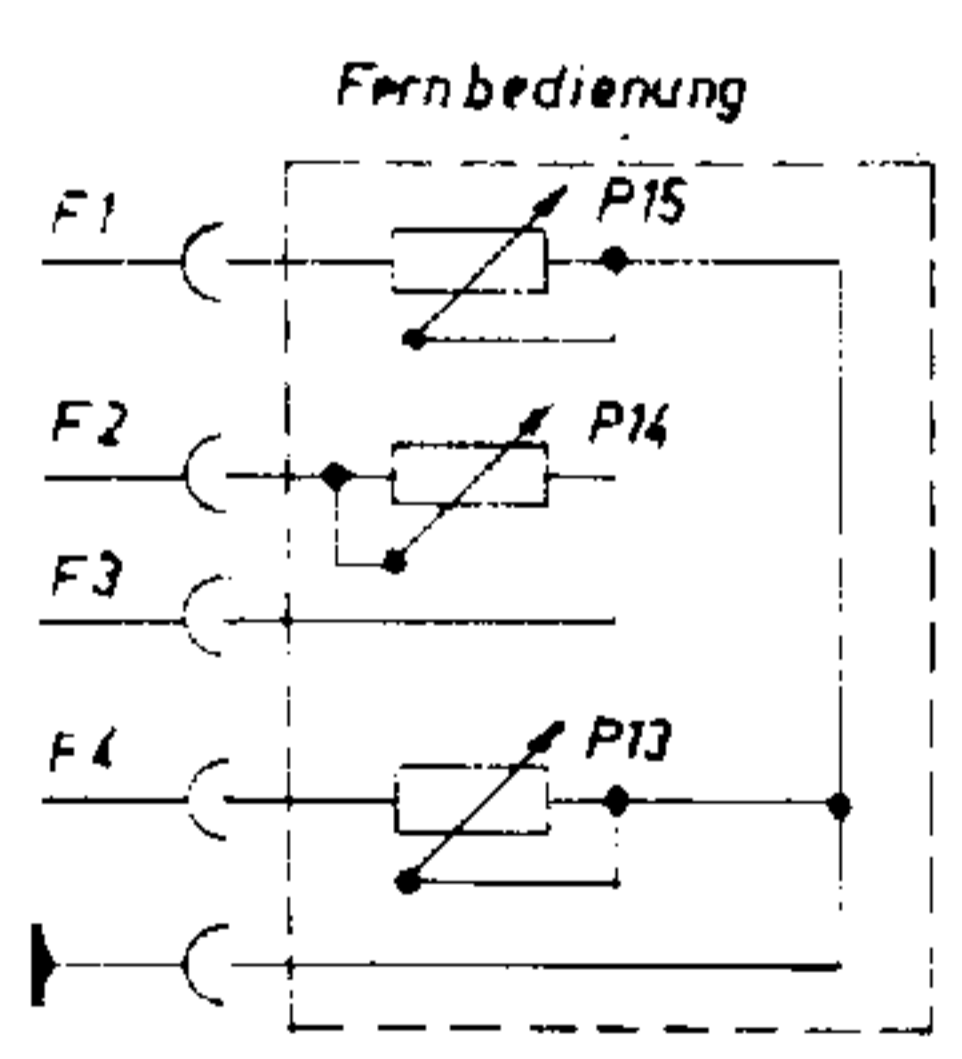
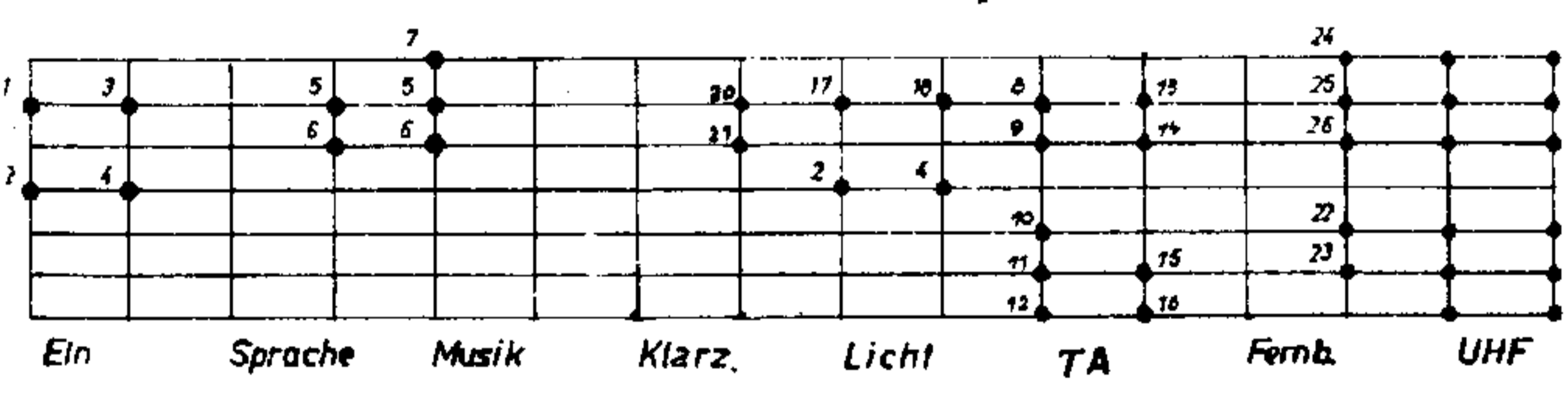
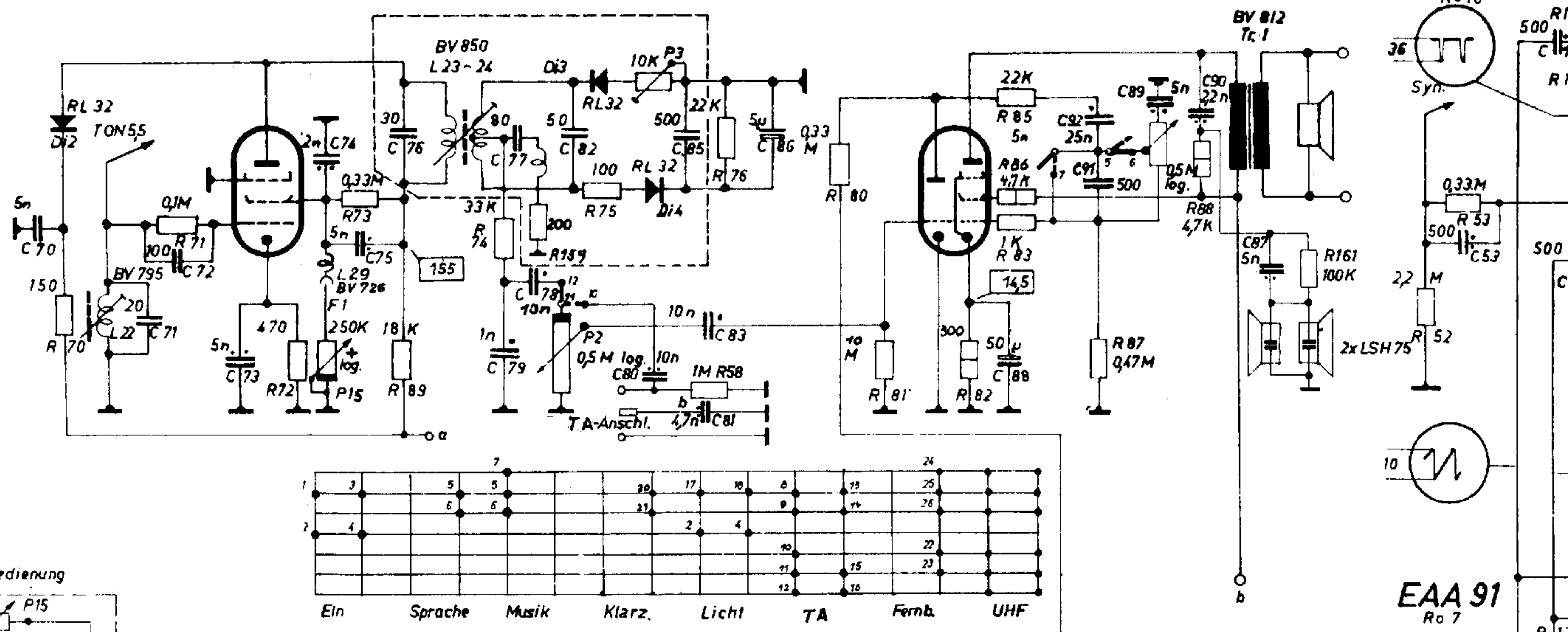

EF 80  
Rö 4

EF 80  
Rö 5

PCL 84  
Rö 6

PM 84  
Rö 19

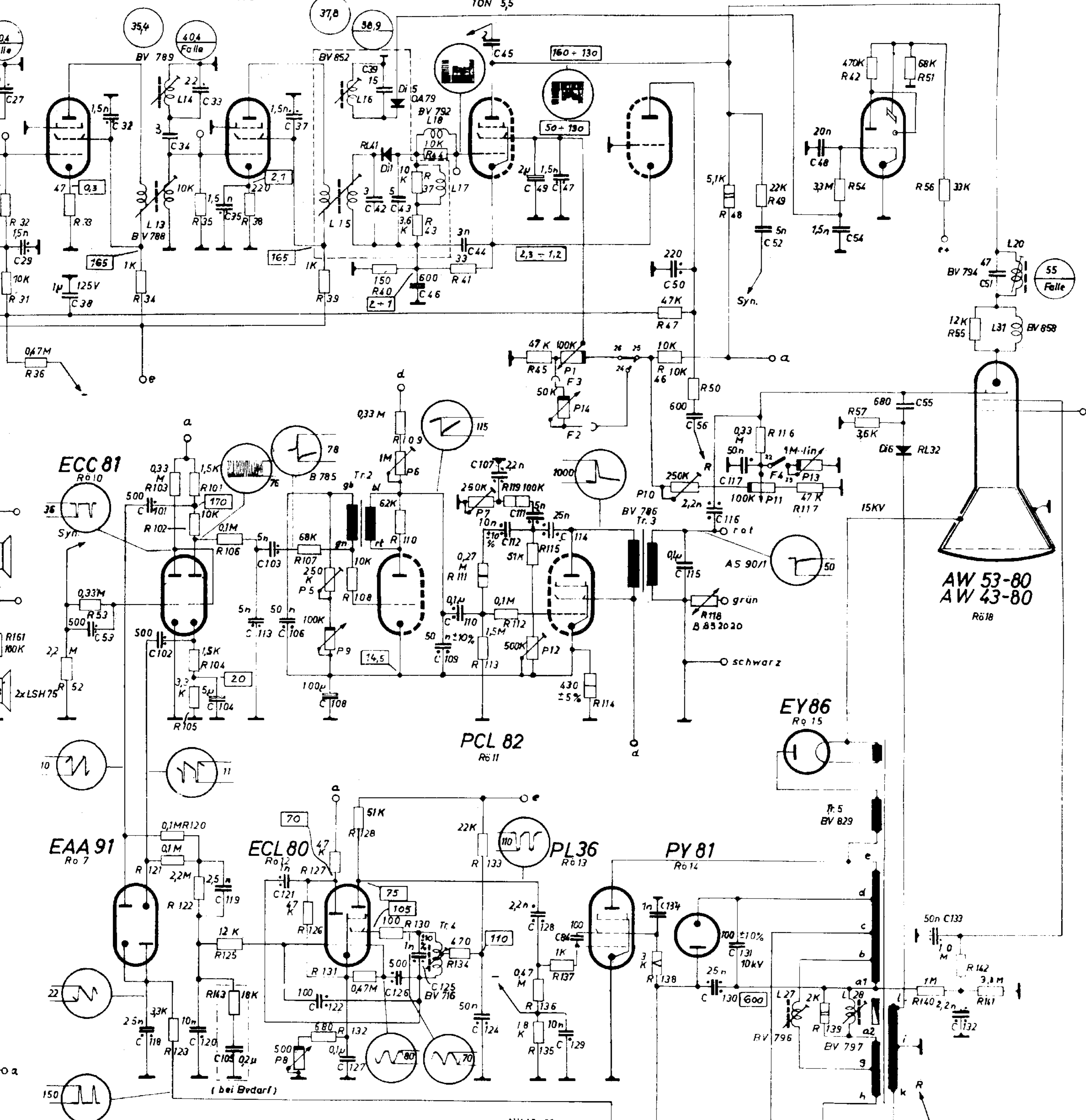

0,5 W

1 W

2 W

4 W

3 W

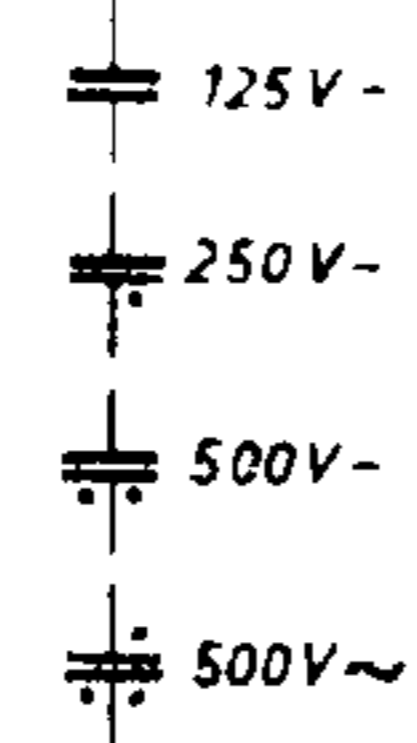

Spannungswerte in Volt mit Instr. 666Ω/V gemessen.

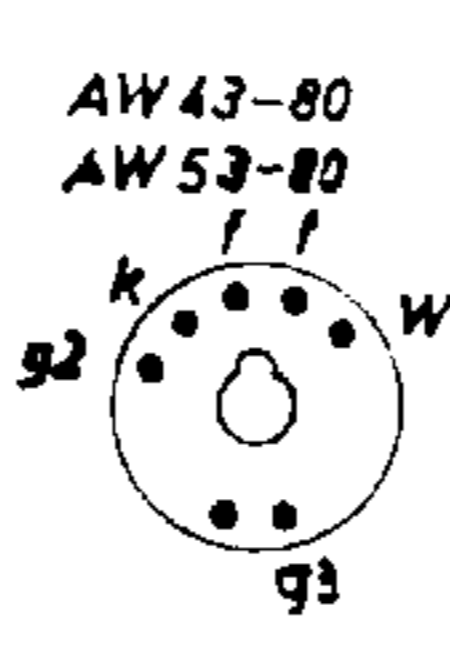

Bildjuwel 917 - S  
Bildjuwel 921 - S  
TONFUNK G.M.B.H. KARLSRUHE



Impulse von Spitze zu Spitze in Volt gemessen.

Sch. 12439  
Änderungen vorbehalten. 13.5.58.

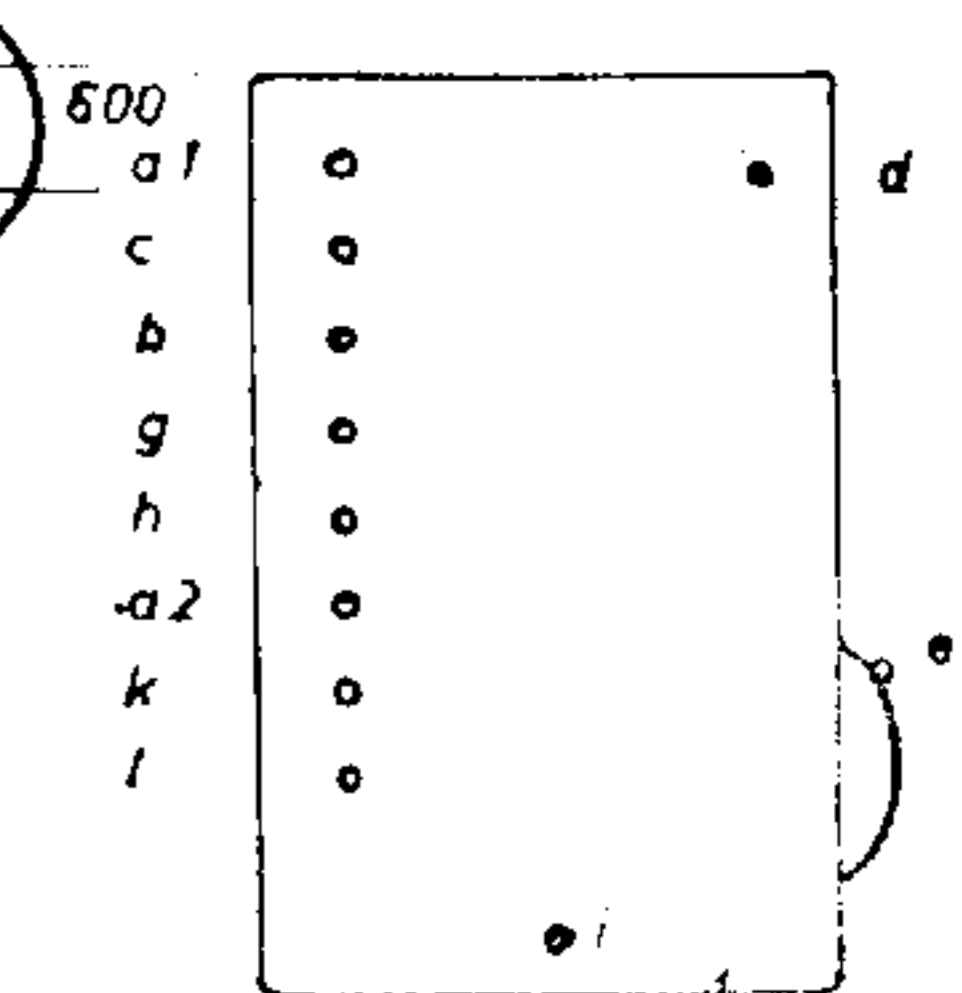

Anschlüsse am Zeilentrafo