

FD 041.17.

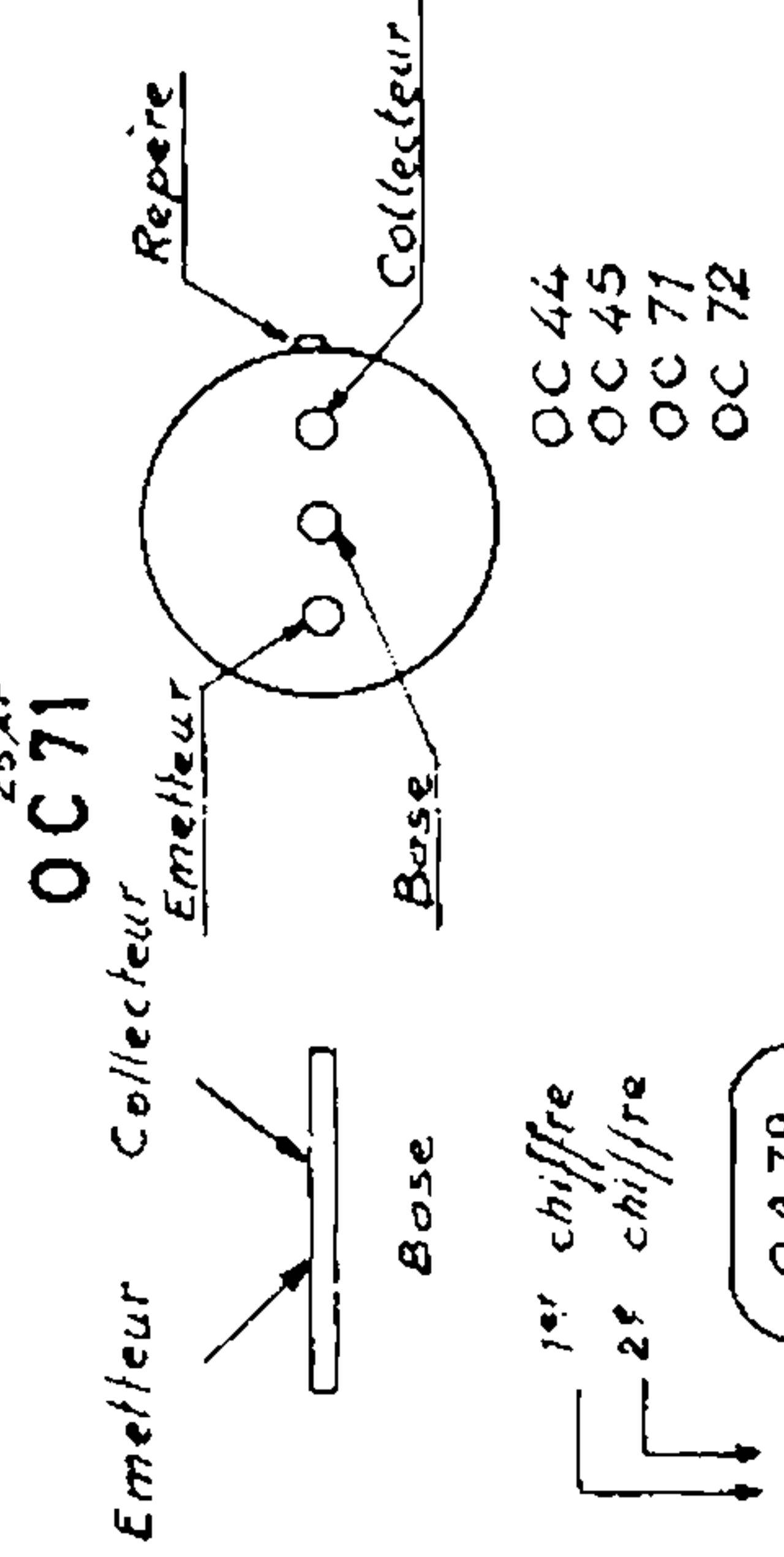

**RECEPTEUR**  
Type S.B.R. P9

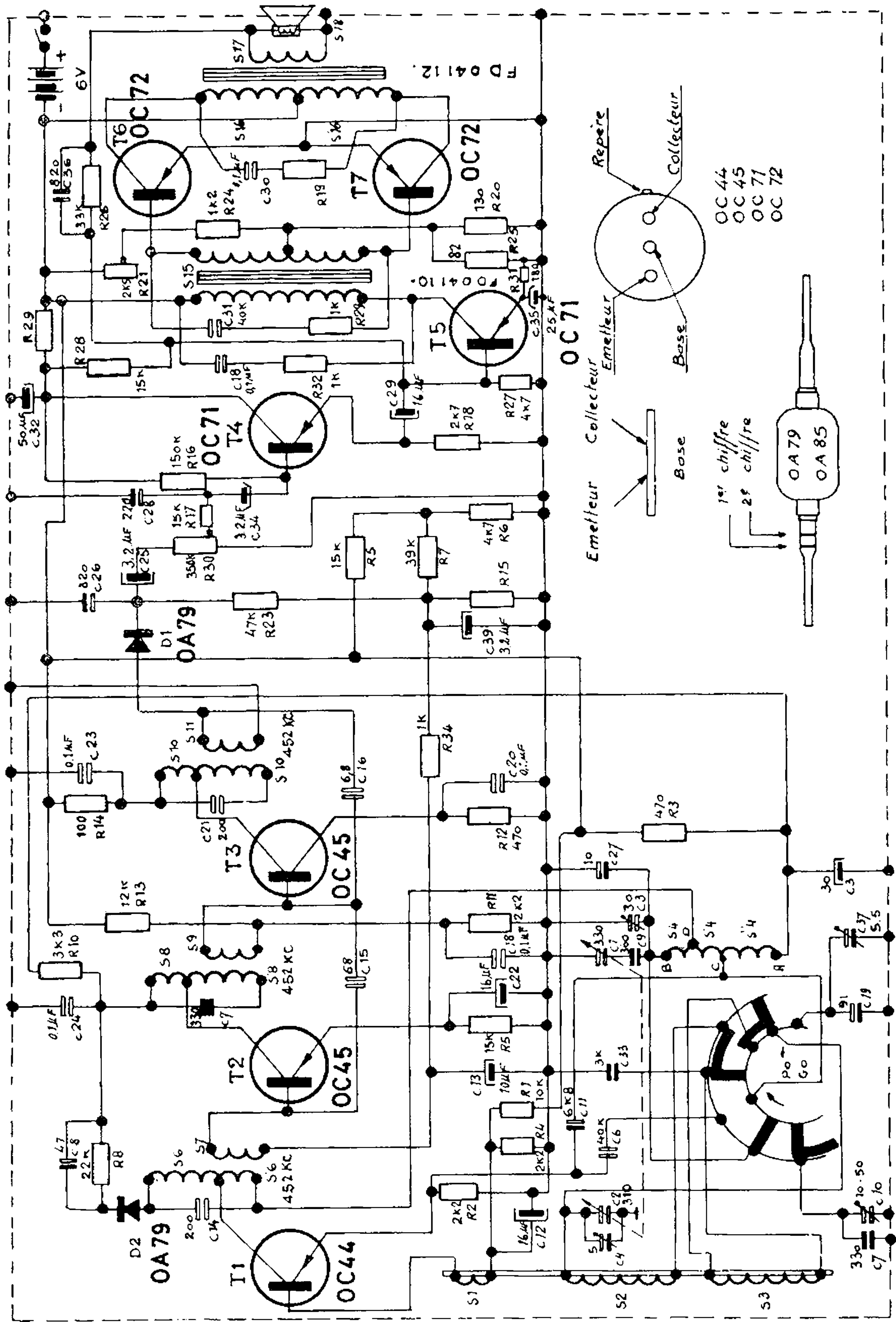
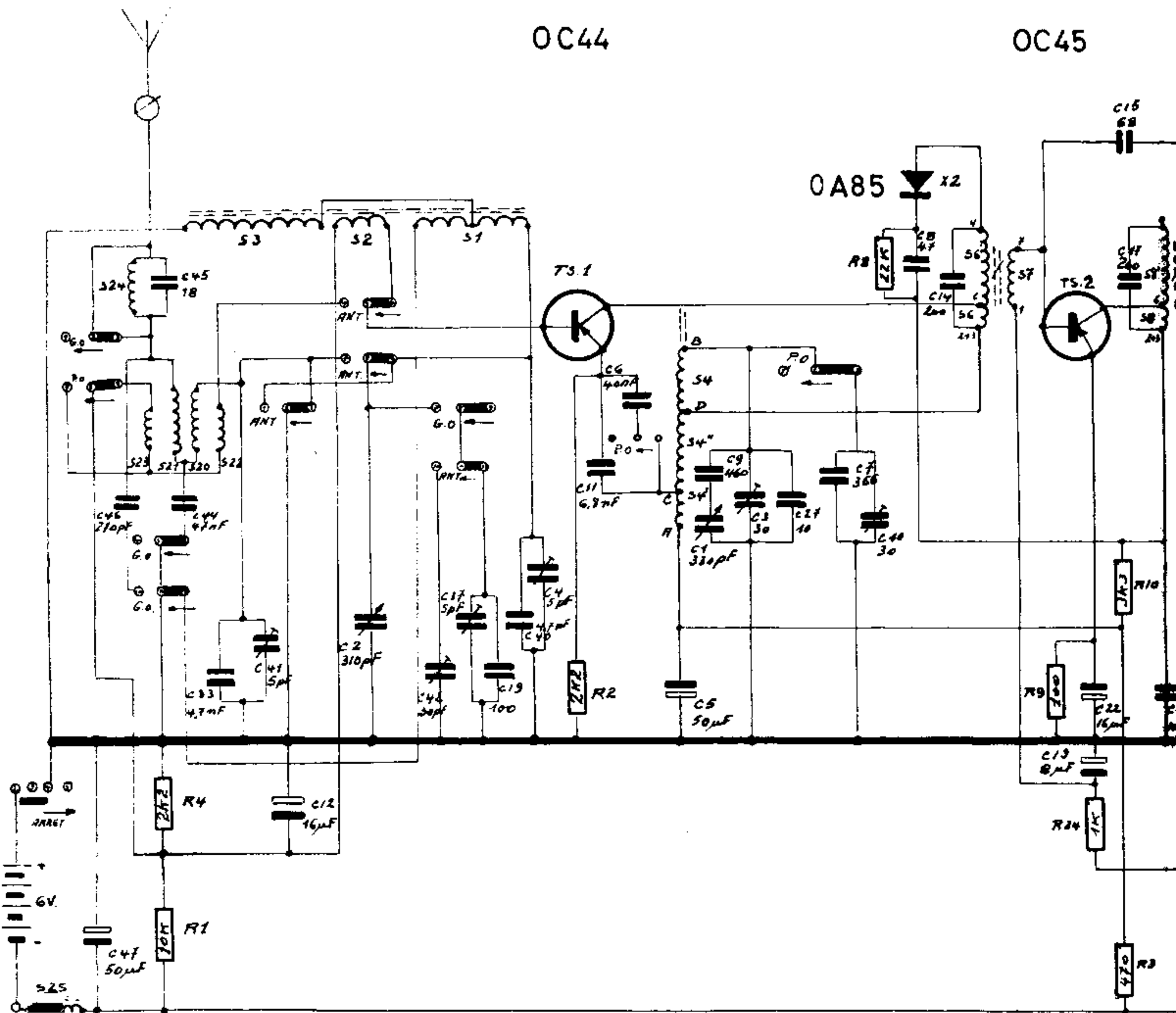

25	24	23	21	20	22	3	2	1	4.4.4"				6.6' F				8.8											
46	47	45	44	33	41	12	2	42	37	19	40	4	11	6	5	9	1	3	27	37	10	8	14	18	22	15	17	20
						14							2							B	9	34	3	18				

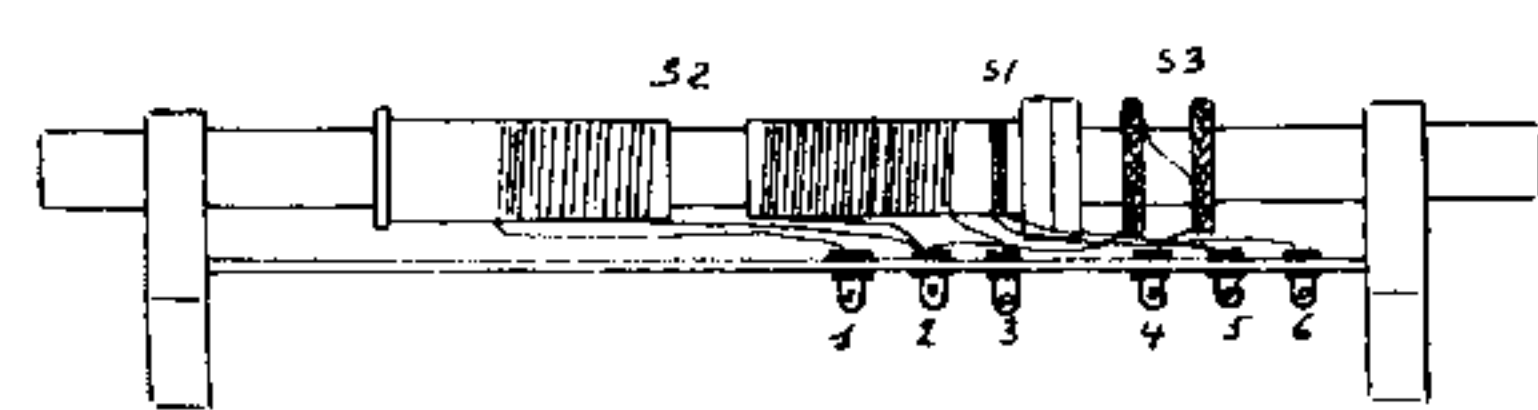

Cadre Ferrocube.

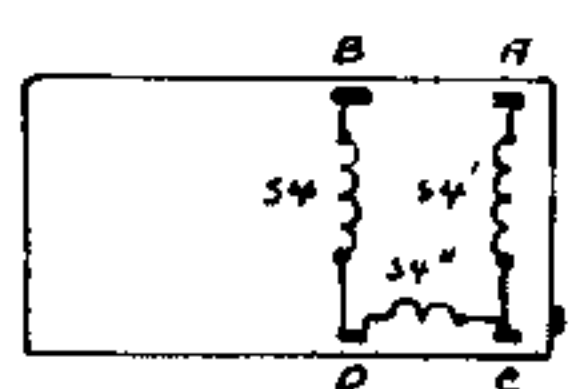

Oscillateur.

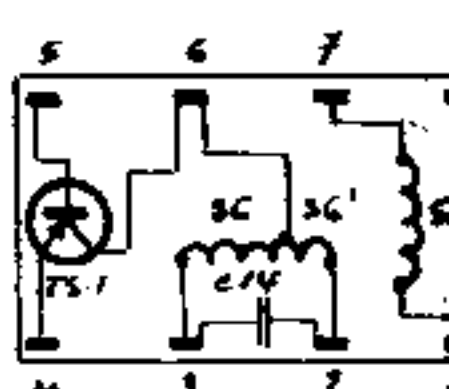

Filtre MF3

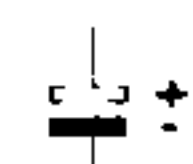

OC44

OC45

OC45

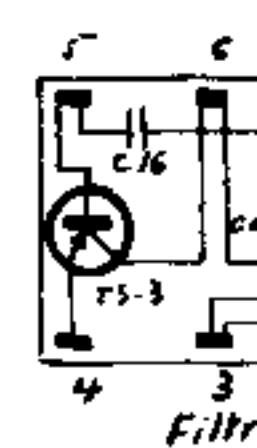
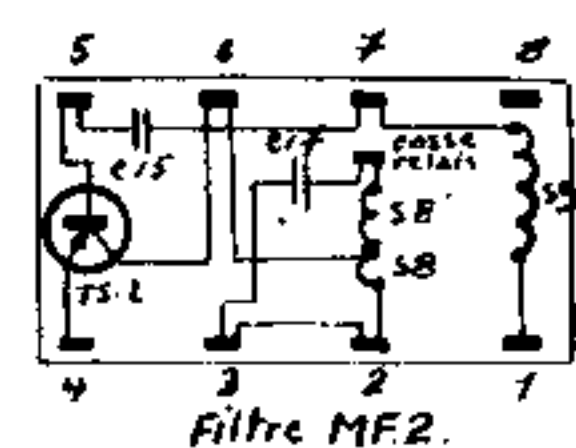
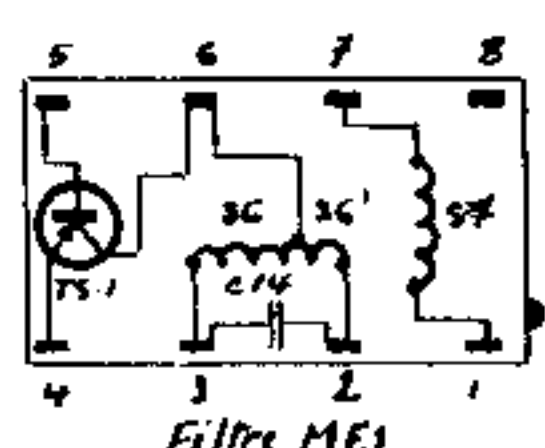
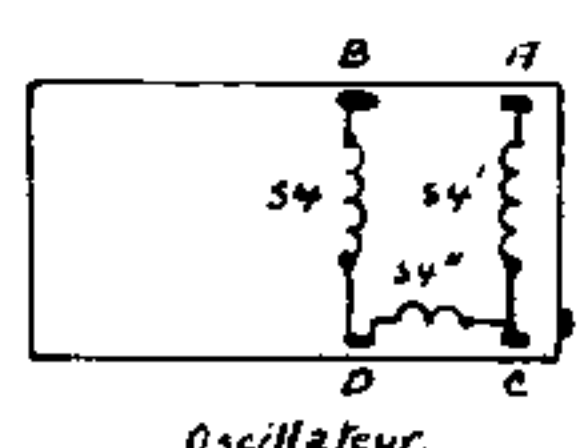
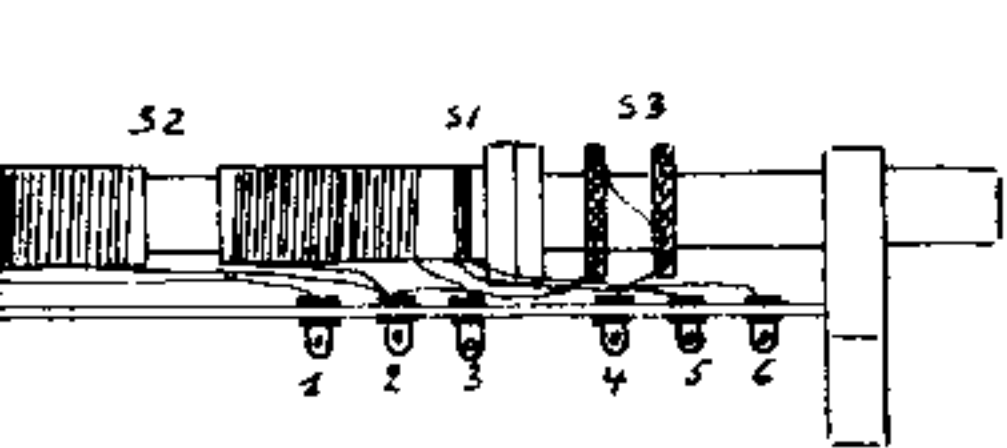
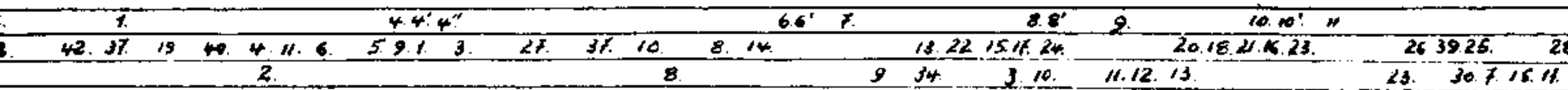
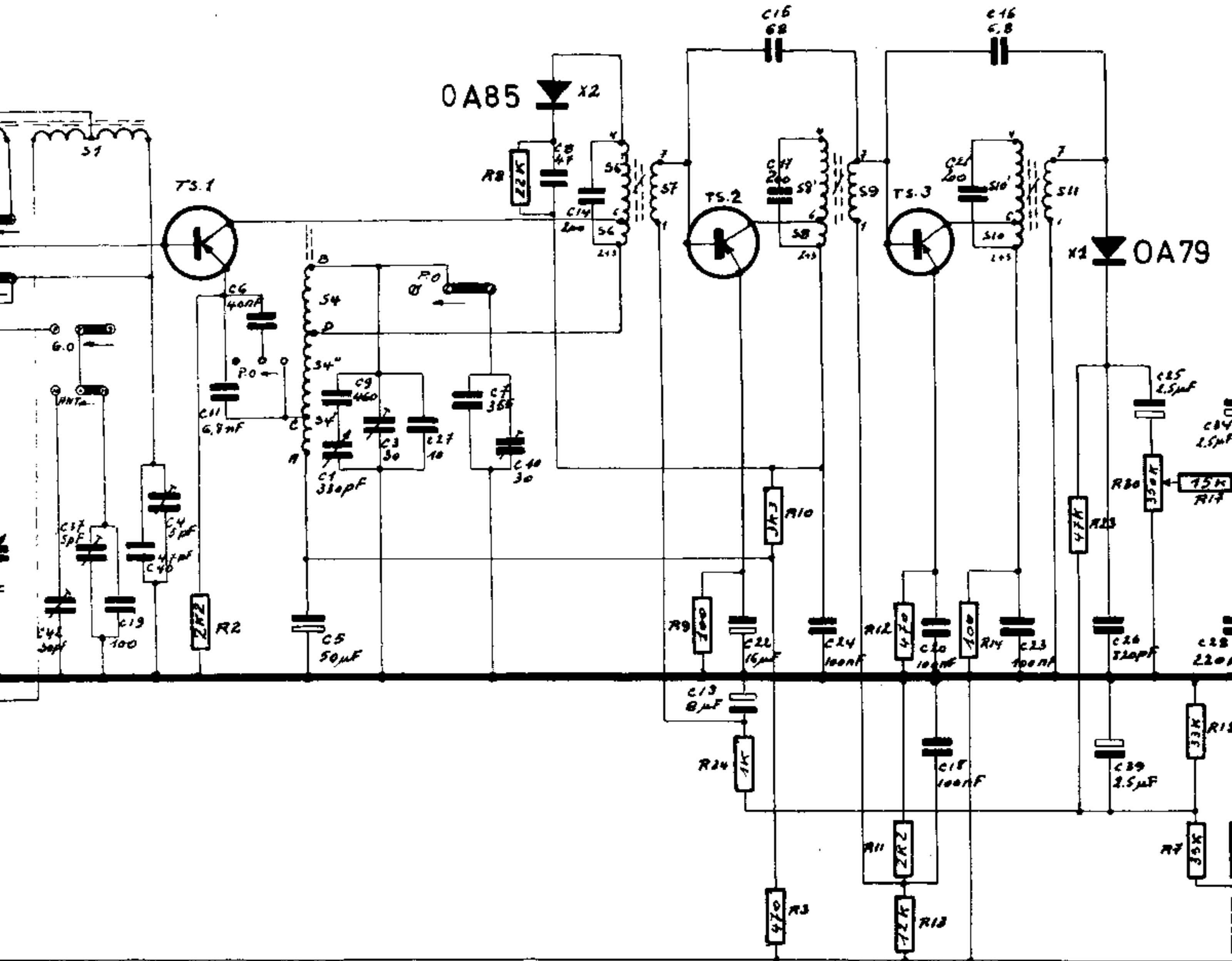

Cadre Ferroscube.

Oscillateur.

Filtre MF1.

Filtre MF2.

Filtre.

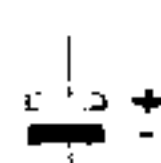

OC45

OC71

OC71

2 x OC72

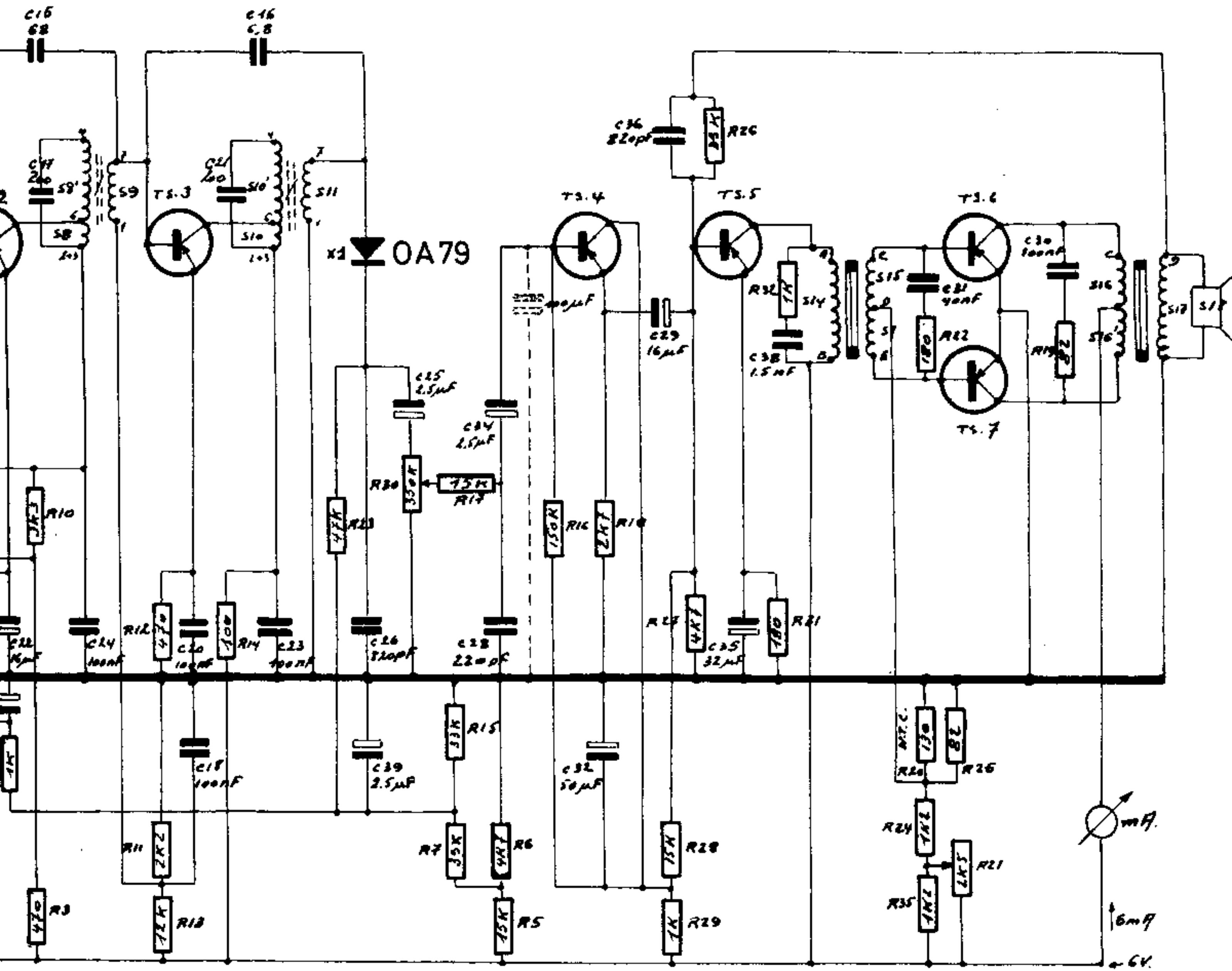

8.8'	9.	10.10'	11	14.	16.15'	16.16'	17.19.
22.15.17.24	20.18.21.16.23.	26.39.25.	28.34.	32.	29.36.	35.38.	31.
3.10.	11.12.13.	23.	30.7.18.11.6.5.	16.	18.27.28.29.26.32.31.	20.24.35.22.25.21.	29.

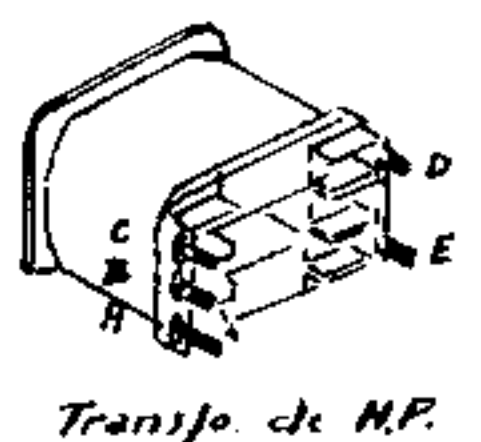
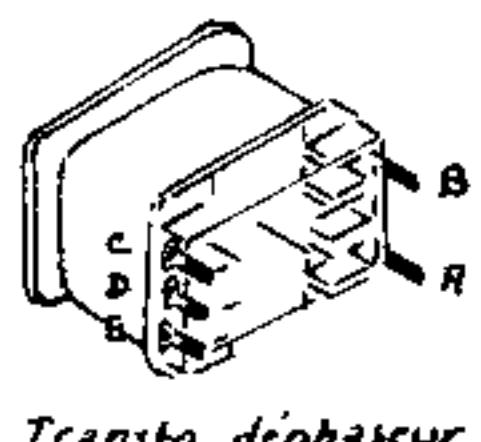
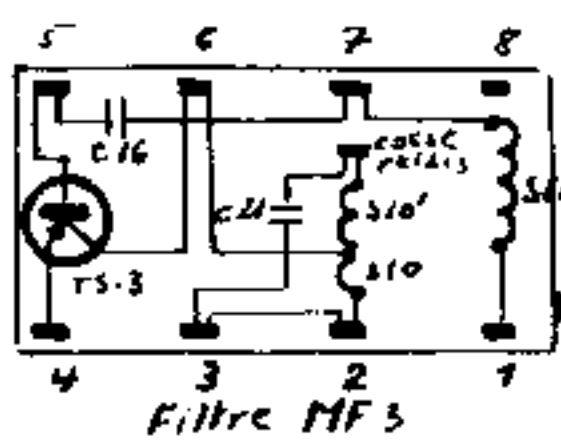
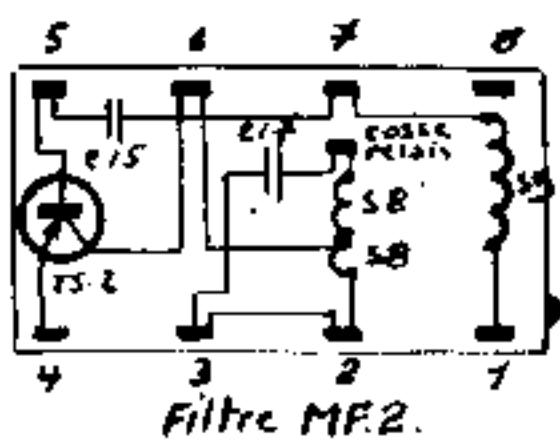
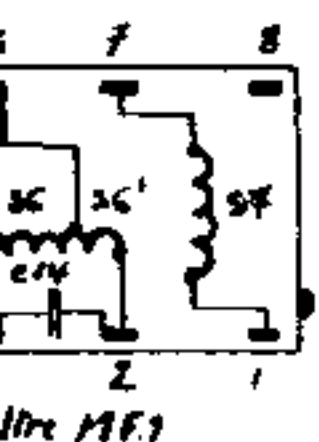

Récepteur Radio Ontvanger

# SBR P.9

DAT: 14/10/58 R-W-P.9-2