

MODEL Radiola II
 MODEL Radiola III
 MODEL Radiola
 Balanced Amp.
 MODEL Radiola Sen. Amp.

R. C. A. VICTOR CO., INC.

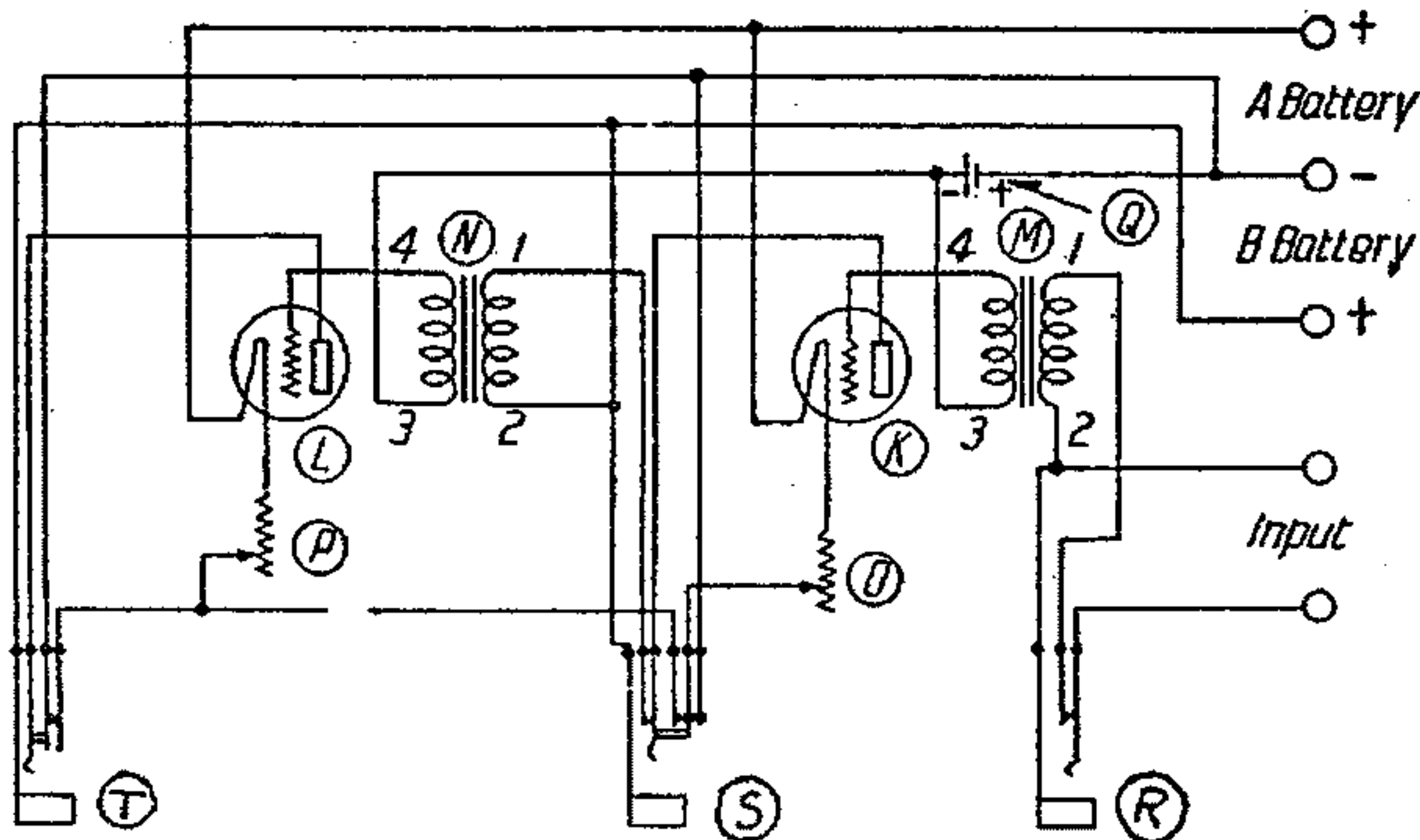

Model Senior Amp.

Model Radiola Senior Amplifier (1922)

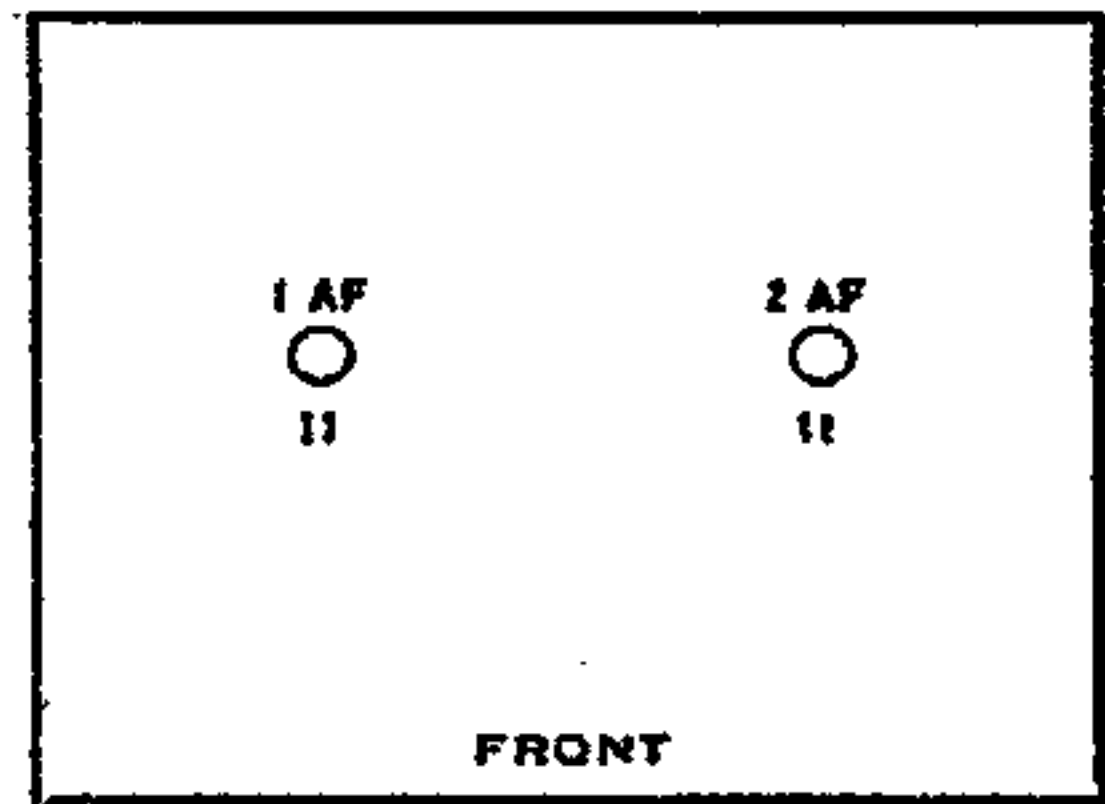

Model Radiola II

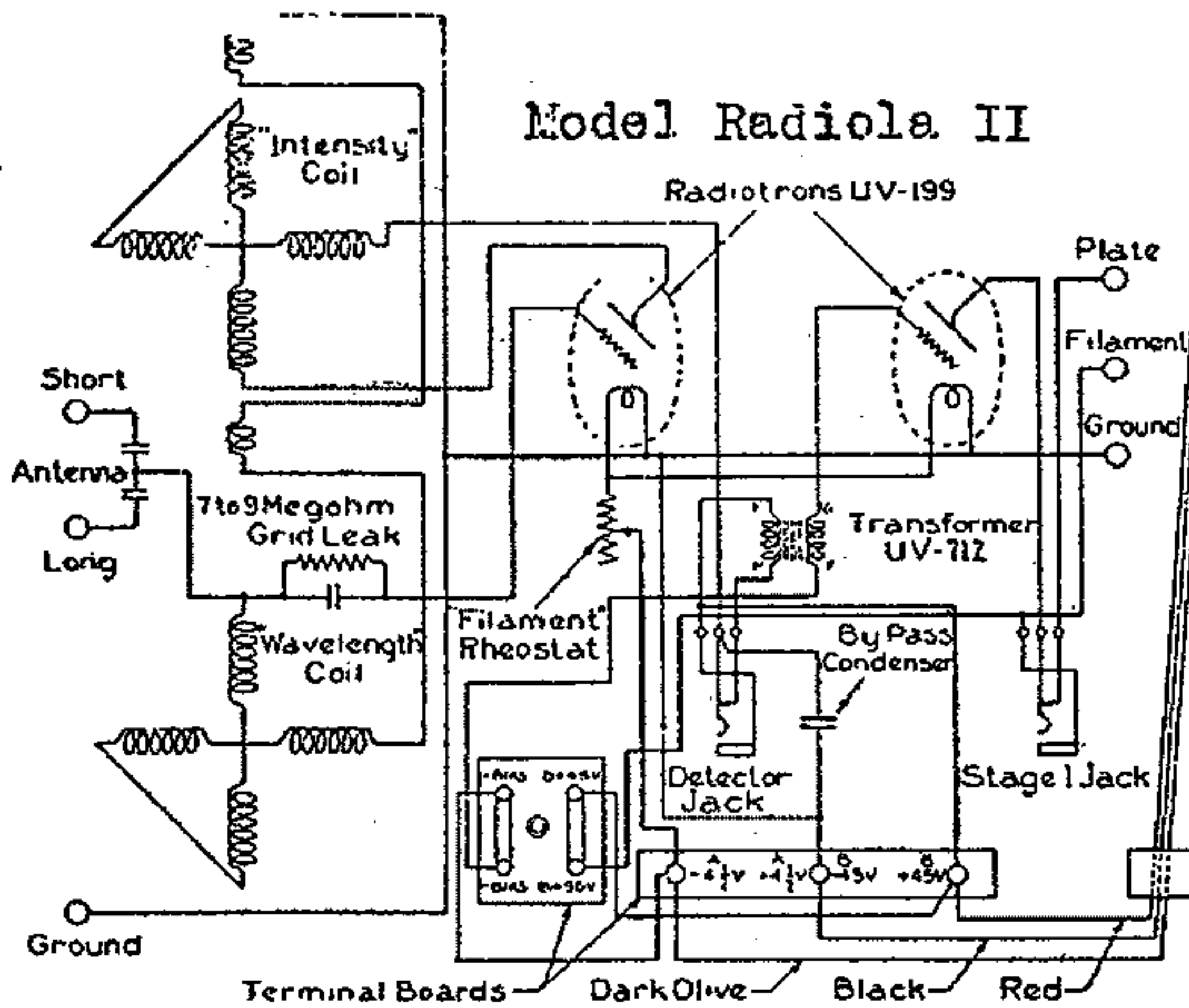

Two Flashlight Batteries
 4 1/2 Volts 1 1/2 Dia. x 7"

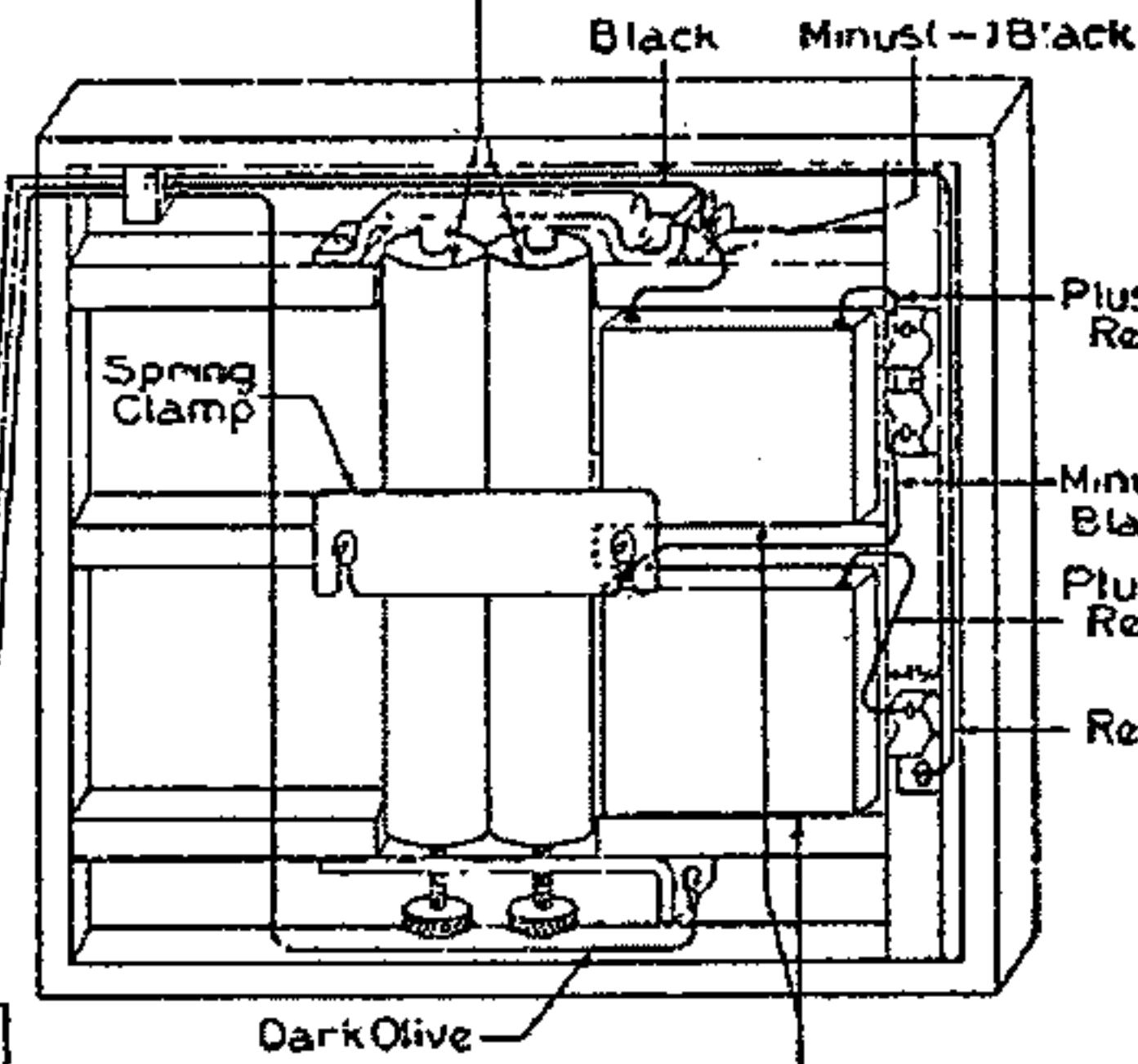

Model Radiola II (1924)

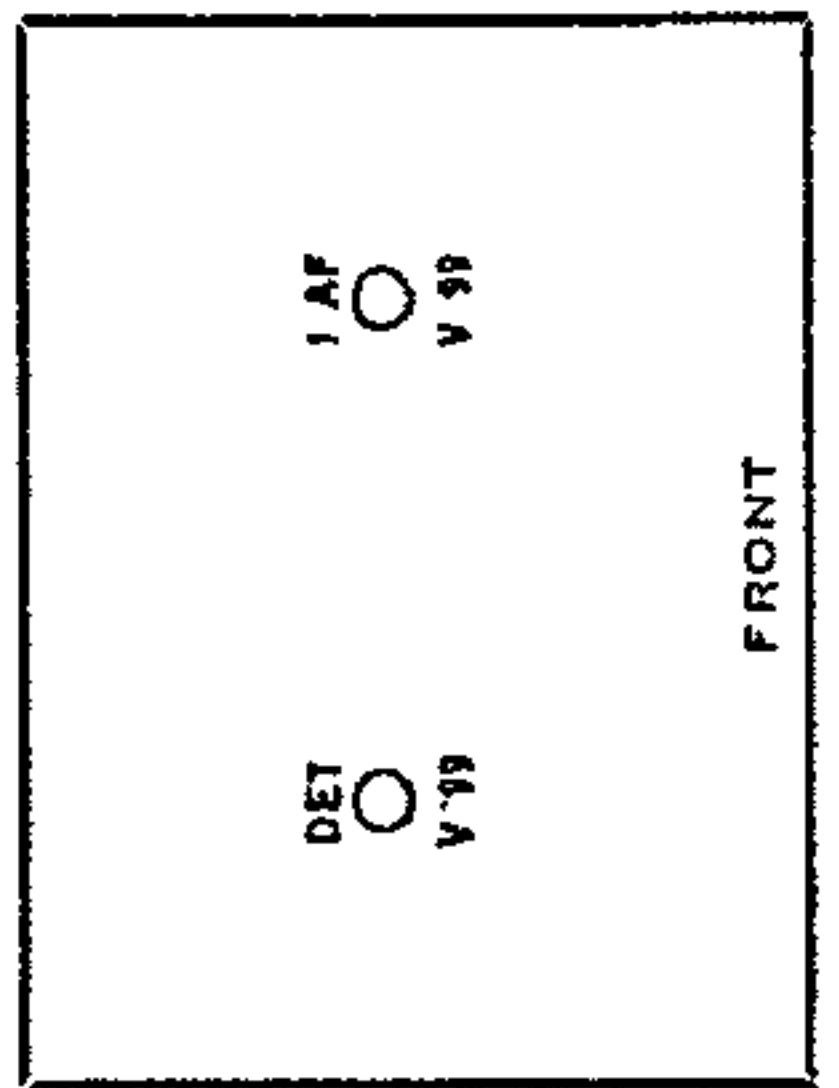

Model Balanced Amp.

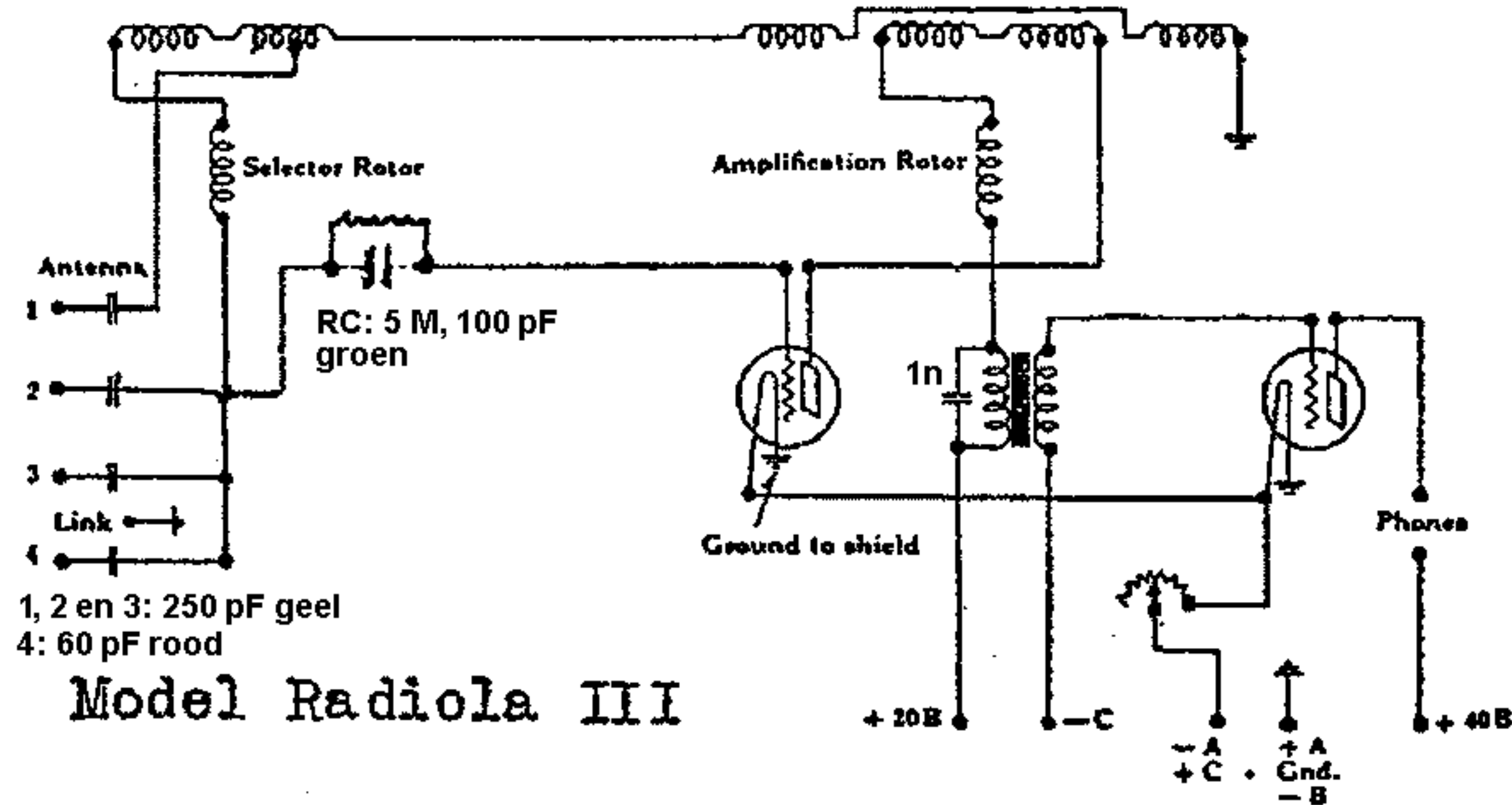

Model Radiola III

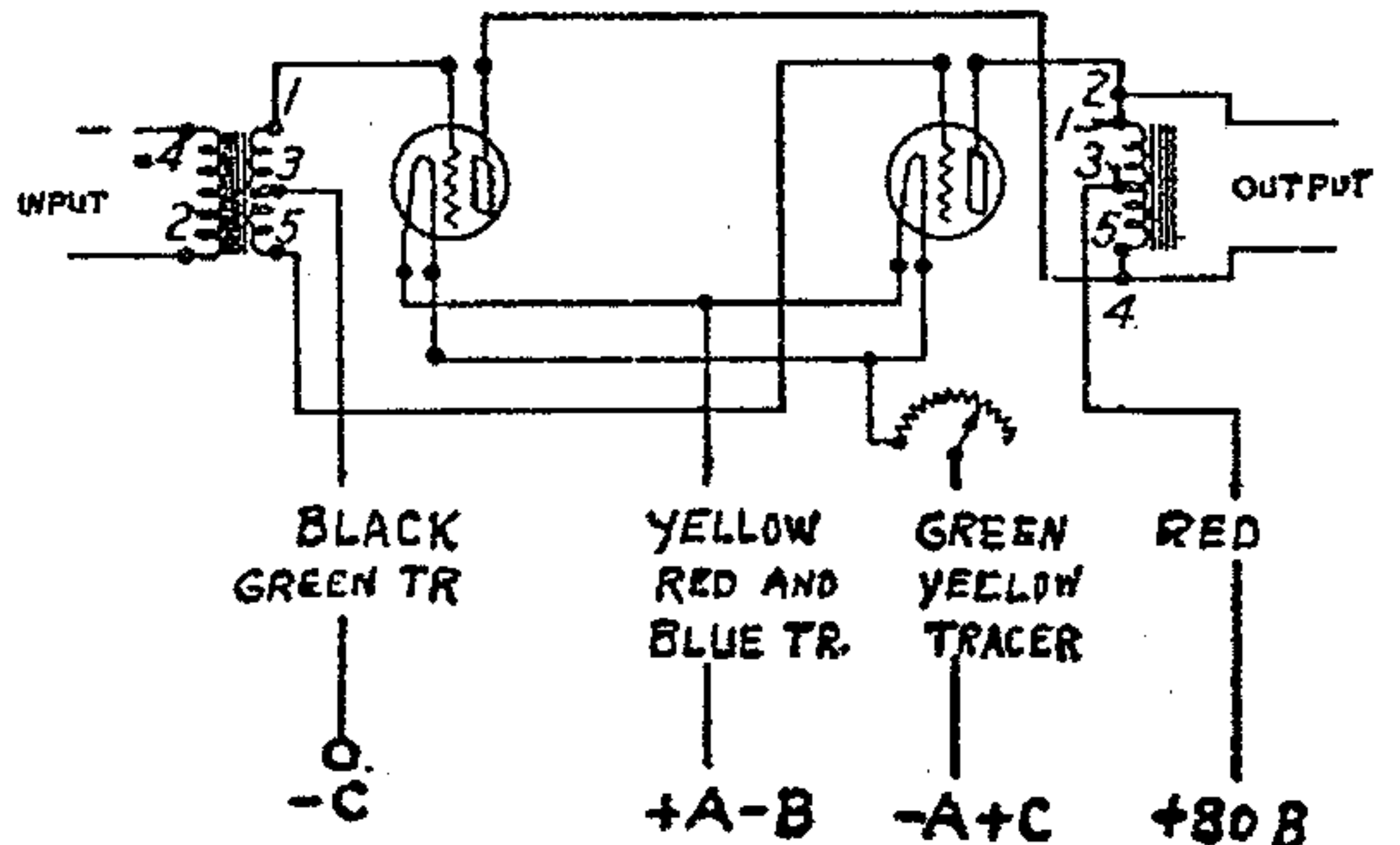

Model Radiola Balanced Amplifier (1924)

Model Radiola III (1924)

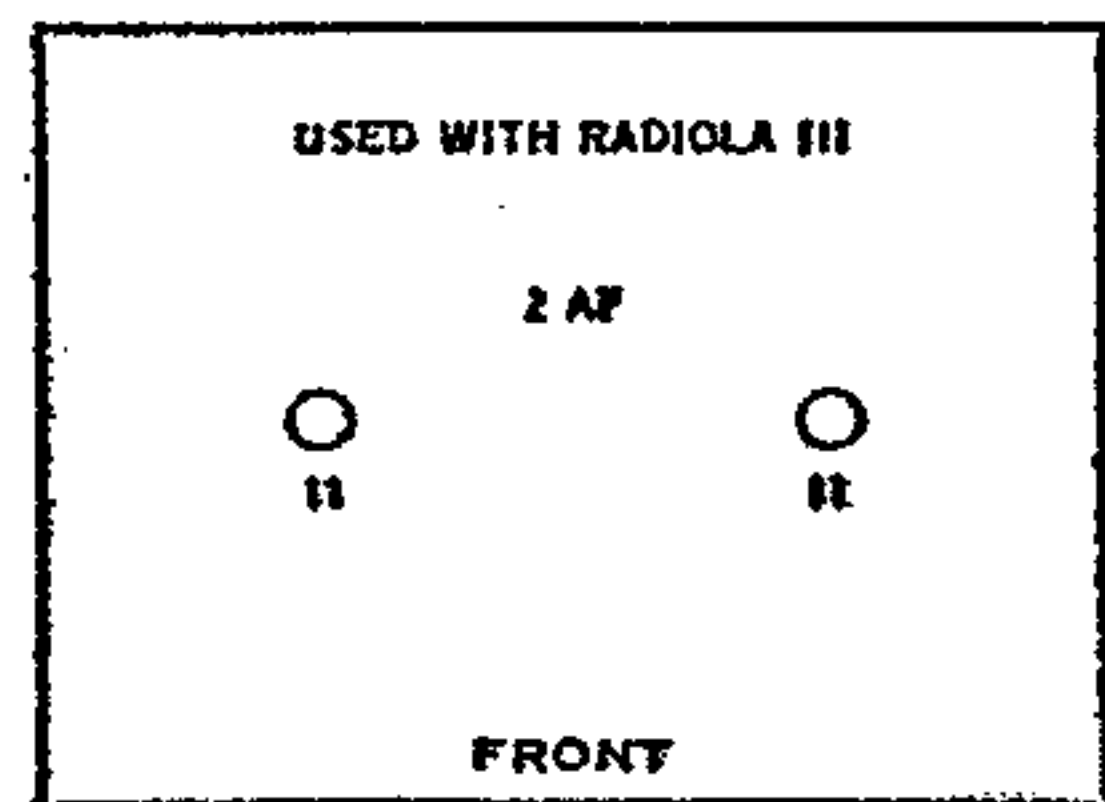
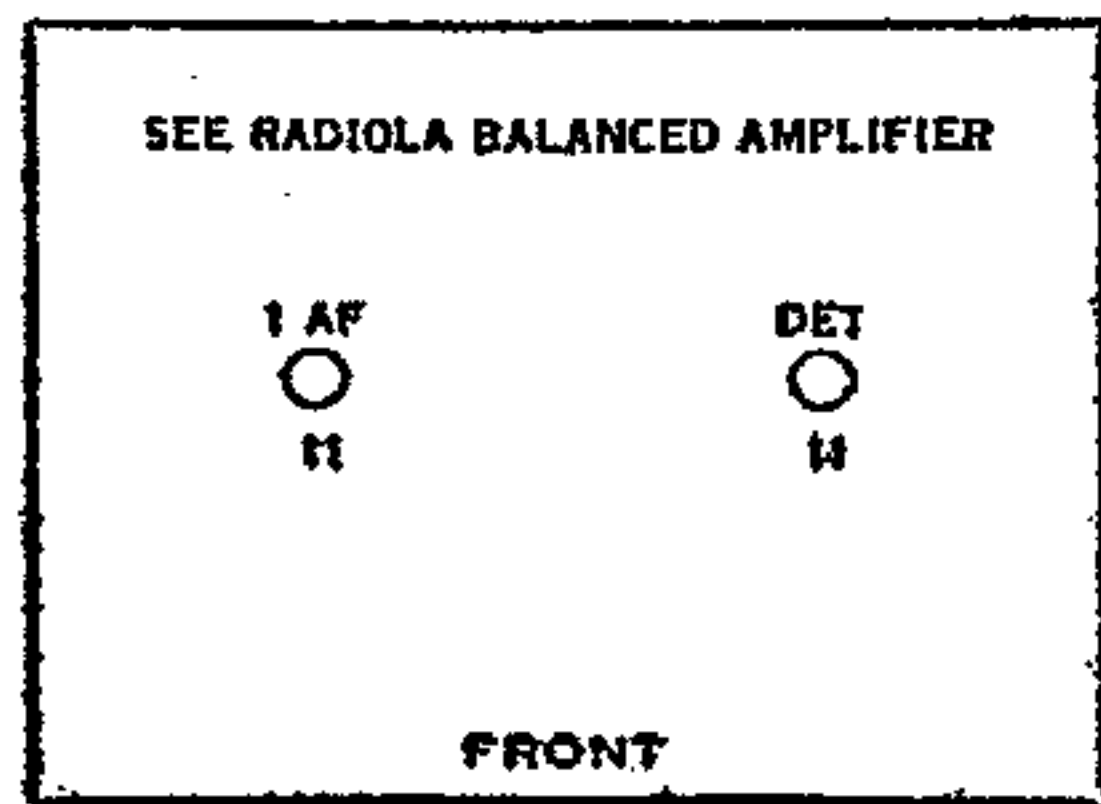

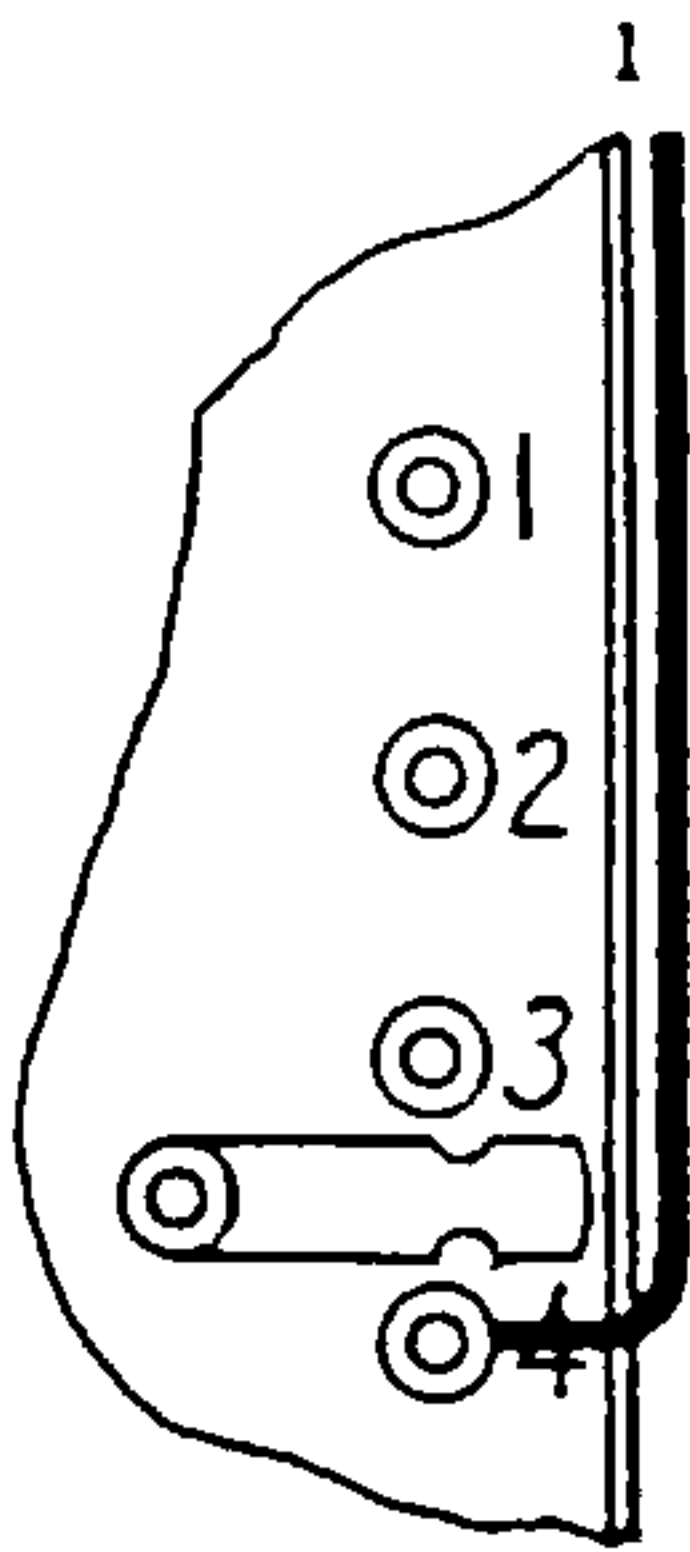

**Short Wave
Single Circuit**

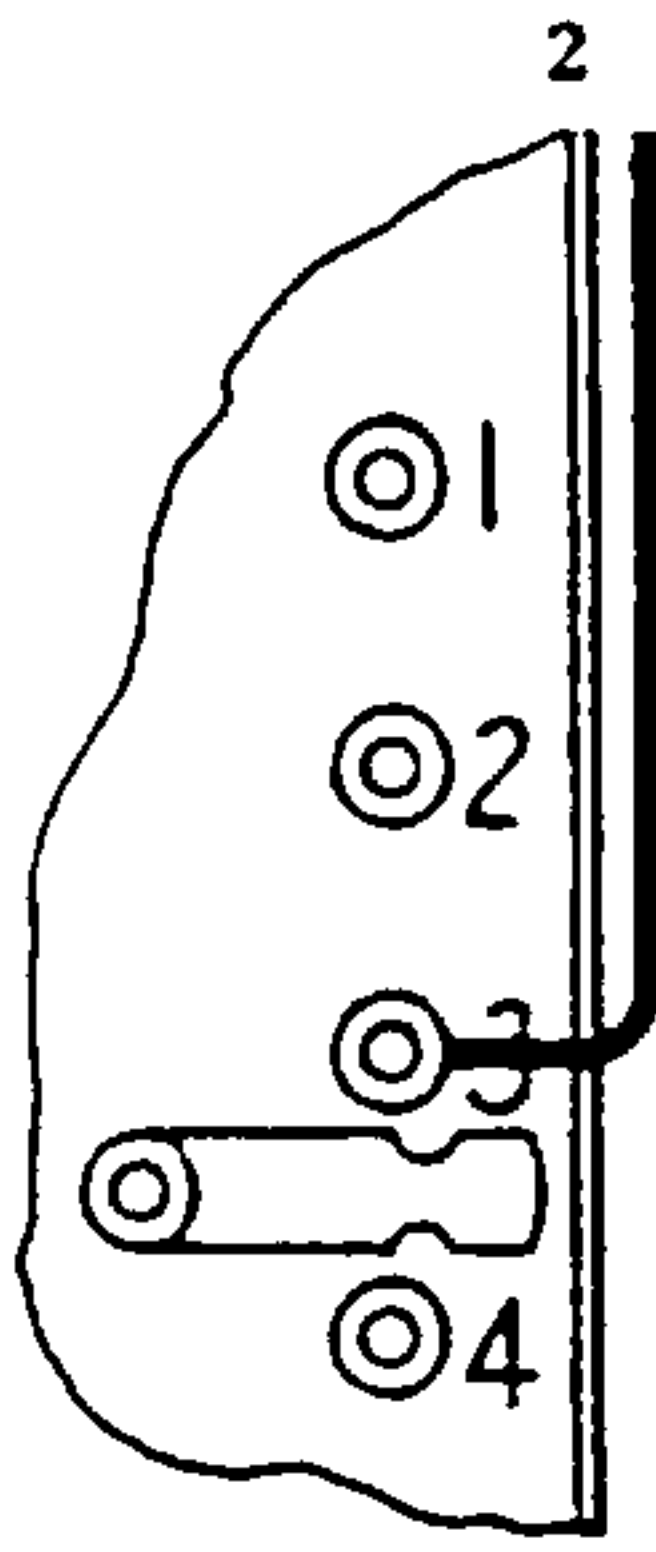

**Medium Wave
Single Circuit**

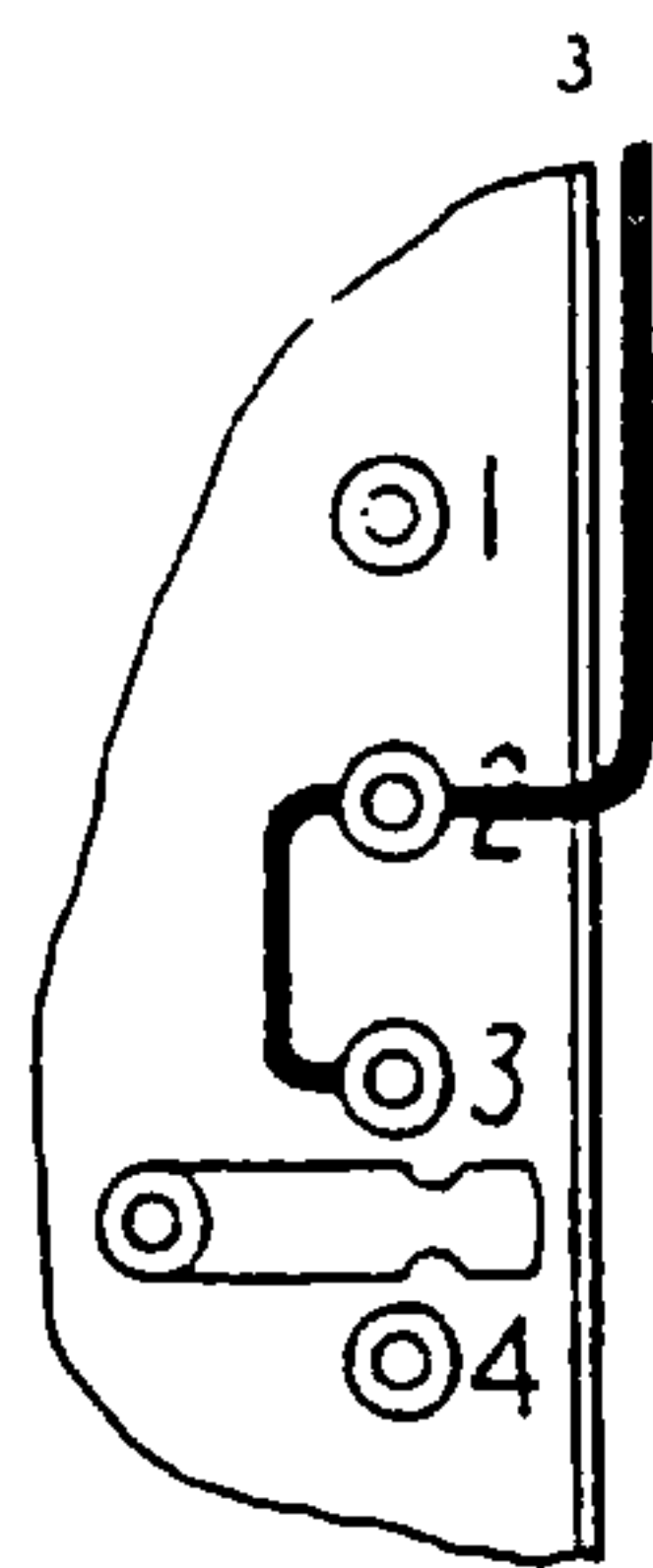

**Long Wave
Single Circuit**

For any Antenna

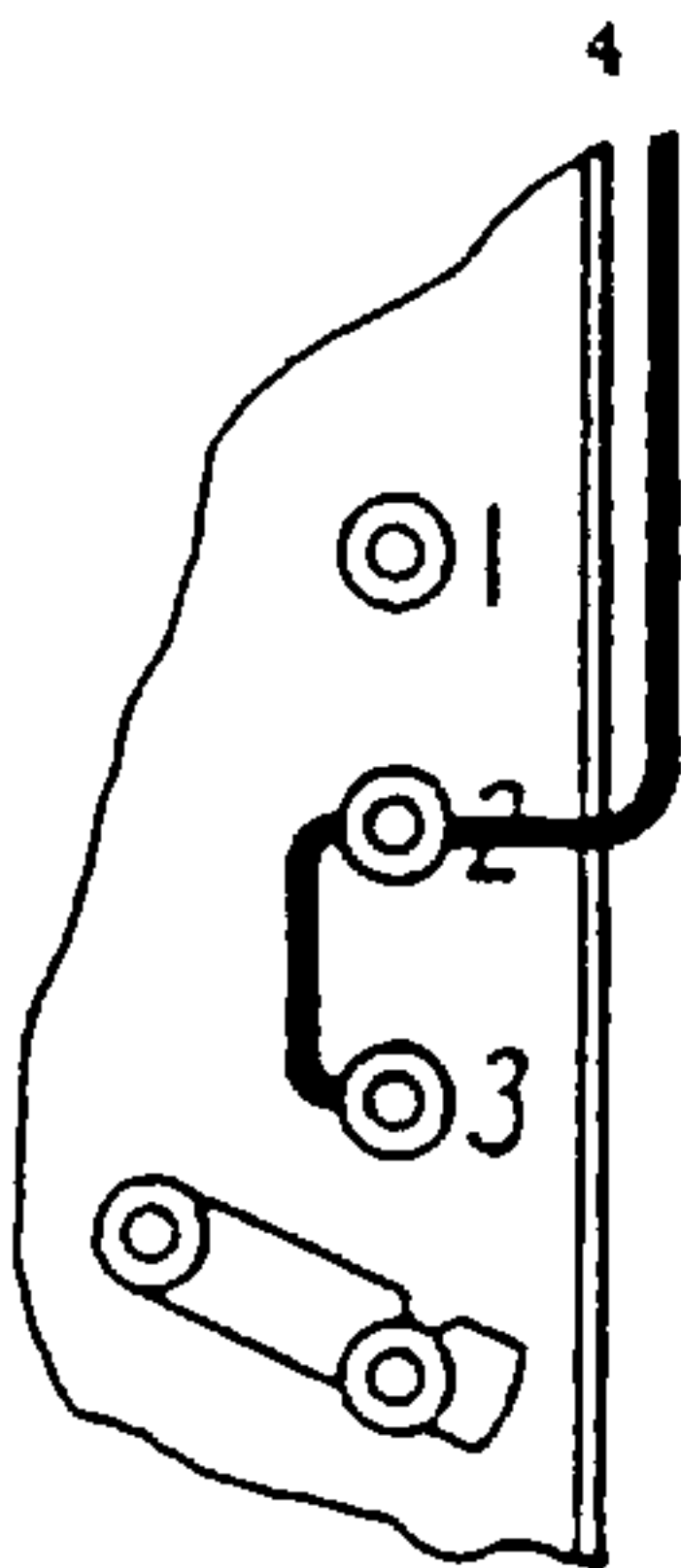

**Long Wave
for very
Small Antenna**

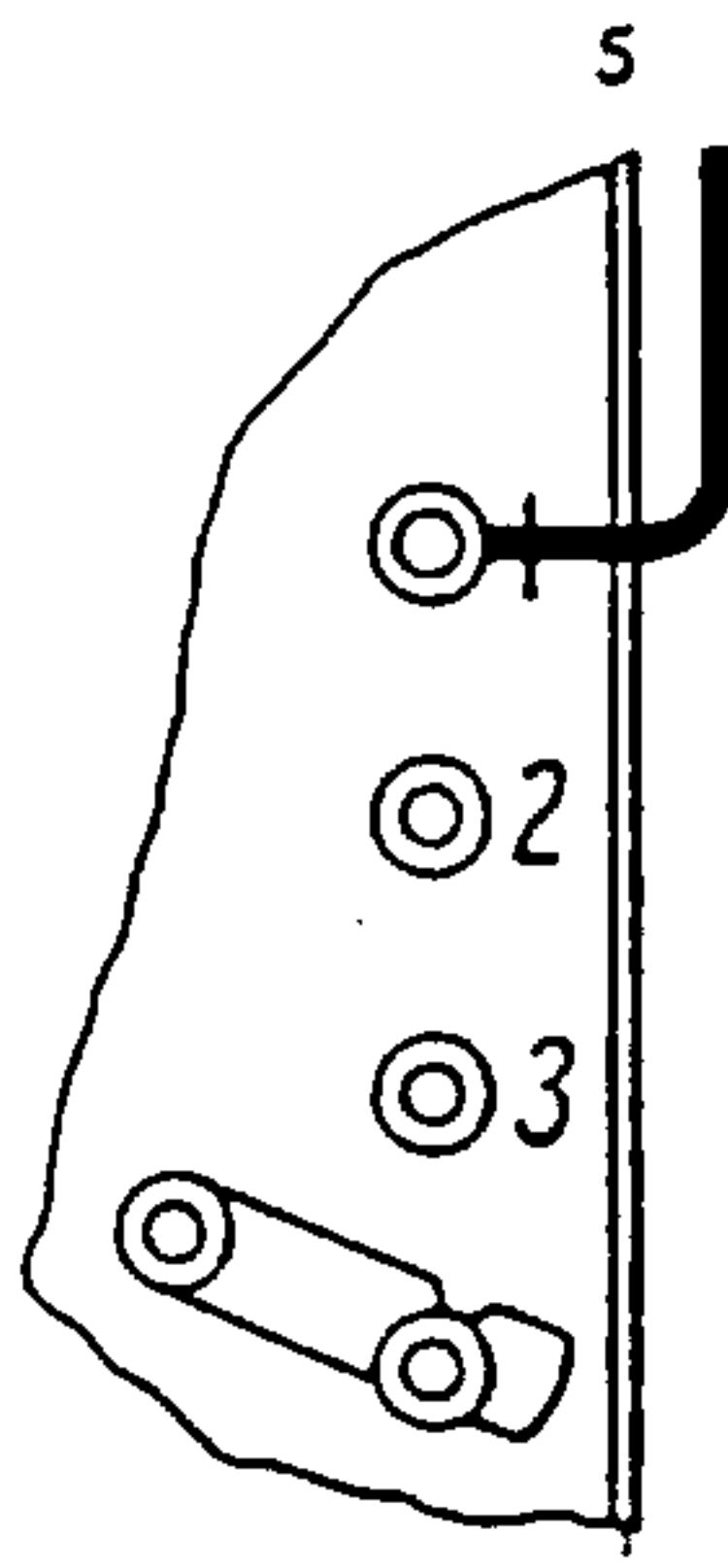

**Short Wave
Selective
Circuit**

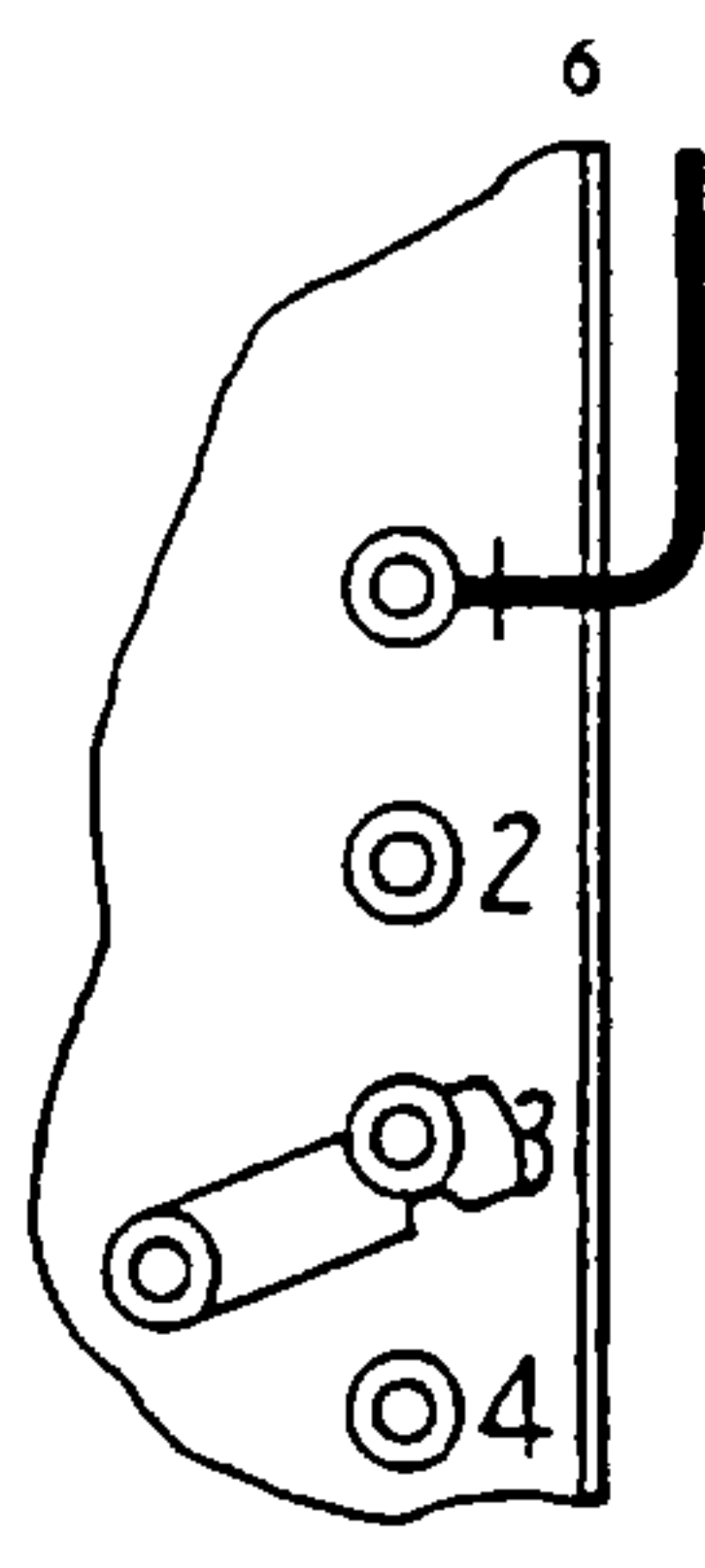

**Long Wave
Selective
Circuit**

For any Antenna

Fig. 3—Showing Antenna Connections to Different Binding Posts