

Operating Instructions

STEREO AMPLIFIER

SA-770

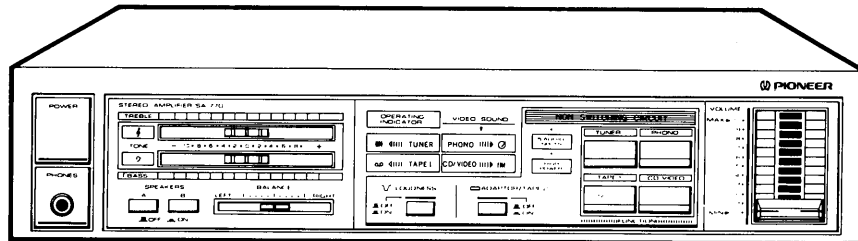

Thank you for buying this Pioneer product.

Please read through these operating instructions so you will know how to operate your model properly. After you have finished reading the instructions, put them away in a safe place for future reference.

In some countries or regions, the shape of the power plug and power outlet may sometimes differ from that shown in the explanatory drawings. However, the method of connecting and operating the unit is the same.

WARNING: TO PREVENT FIRE OR SHOCK HAZARD, DO NOT EXPOSE THIS APPLIANCE TO RAIN OR MOISTURE.

IMPORTANT NOTICE

[For U.S. and Canadian models]

The serial number for this equipment is located on the rear panel. Please write this serial number on your enclosed warranty card and keep in a secure area. This is for your security.

[For Canadian model]

CAUTION: TO PREVENT ELECTRIC SHOCK DO NOT USE THIS (POLARIZED) PLUG WITH AN EXTENSION CORD, RECEPTACLE OR OTHER OUTLET UNLESS THE BLADES CAN BE FULLY INSERTED TO PREVENT BLADE EXPOSURE.

ATTENTION: POUR PREVENIR LES CHOCS ELECTRIQUES NE PAS UTILISER CETTE FICHE POLARISEE AVEC UN PROLONGATEUR UNE PRISE DE COURANT OU UNE AUTRE SORTIE DE COURANT, SAUF SI LES LAMES PEUVENT ETRE INSEREES A FOND SANS EN LAISSER AUCUNE PARTIE A DECOUVERT.

LINE VOLTAGE SELECTOR SWITCH

Only multi-voltage models are provided with this switch. U.S., Canadian, European, U.K., and Australian models are not provided with this switch.

The line voltage selector switch is on the rear panel. Before your model is shipped from the factory, this switch is set to the power requirements of the destination. Check that it is set properly before plugging the power cord into the AC outlet. If the voltage is not properly set or if you move to an area where the voltage requirements differ, adjust the selector switch as follows.

1. Use a medium-size screwdriver.
2. Insert the screwdriver into the arrow on the voltage selector, and adjust so that the tip of the arrow points to the voltage value of your area.

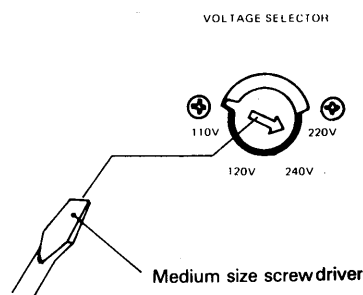

PIONEER®

SAFETY INSTRUCTIONS

READ INSTRUCTIONS — All the safety and operating instructions should be read before the appliance is operated.

RETAIN INSTRUCTIONS — The operating instructions should be retained for future reference.

HEED WARNING — All warnings on the appliance and in the operating instructions should be adhered to.

FOLLOW INSTRUCTIONS — All operating and use instructions should be followed.

WATER AND MOISTURE — The appliance should not be used near water — for example, near a bathtub, washbowl, kitchen sink, laundry tub, in a wet basement, or near a swimming pool, etc.

LOCATION — The appliance should be installed in a stable location.

WALL OR CEILING MOUNTING — The appliance should not be mounted to a wall or ceiling.

VENTILATION — The appliance should be situated so that its location or position does not interfere with its proper ventilation. For example, the appliance should not be situated on a bed, sofa, rug, or similar surface that may block the ventilation openings; or, placed in a built-in installation, such as a bookcase or cabinet that may impede the flow of air through the ventilation openings.

HEAT — The appliance should be situated away from heat sources such as radiators, heat registers, stoves, or other appliances (including amplifiers) that produce heat.

POWER SOURCES — The appliance should be connected to a power supply only of the type described in the operating instructions or as marked on the appliance.

POWER-CORD PROTECTION — Power-supply cords should be routed so that they are not likely to be walked on or pinched by items placed upon or against them, paying particular attention to cords at plugs, convenience receptacles, and the point where they exit from the appliance.

POLARIZATION — If your purchased product is provided with a polarized power plug, please read the following instructions. This product is equipped with a polarized alternating current line plug (a plug having one blade wider than the other). This plug will fit into the power outlet only one way. This is a safety feature. If you are unable to insert the plug fully into the outlet, try reversing the plug. If the plug should still fail to fit, contact your electrician to replace your obsolete outlet. Do not defeat the safety purpose of the polarized plug.

CLEANING — The appliance should be cleaned only with a polishing cloth or a soft dry cloth. Never clean with furniture wax, benzene, insecticides or other volatile liquids since they may corrode the cabinet.

POWER LINES — An outdoor antenna should be located away from power lines.

NONUSE PERIODS — The power cord of the appliance should be unplugged from the outlet when left unused for a long period of time.

OBJECT AND LIQUID ENTRY — Care should be taken so that objects do not fall and liquids are not spilled into the enclosure through openings.

DAMAGE REQUIRING SERVICE — The appliance should be serviced by Pioneer authorized service center or qualified service personnel when:

- The power-supply cord or the plug has been damaged; or
- Objects have fallen, or liquid has been spilled into the appliance; or
- The appliance has been exposed to rain; or
- The appliance does not appear to operate normally or exhibits a marked change in performance; or
- The appliance has been dropped; or the enclosure damaged.

SERVICING — The user should not attempt to service the appliance beyond that described in the operating instructions. For all other servicing, contact the nearest Pioneer authorized service center.

OUTDOOR ANTENNA GROUNDING — If an outside antenna is connected to the antenna terminal, be sure the antenna system is grounded so as to provide some protection against voltage surges and built up static charges.

In the U.S.A. section 810 of the National Electrical Code, ANSI/NFPA No. 70-1984, provides information with respect to proper grounding of the mast and supporting structure, grounding of the lead-in wire to an antenna discharge unit, size of grounding conductors, location of antenna-discharge unit, connection to grounding electrodes, and requirements for the grounding electrode. See Fig. A.

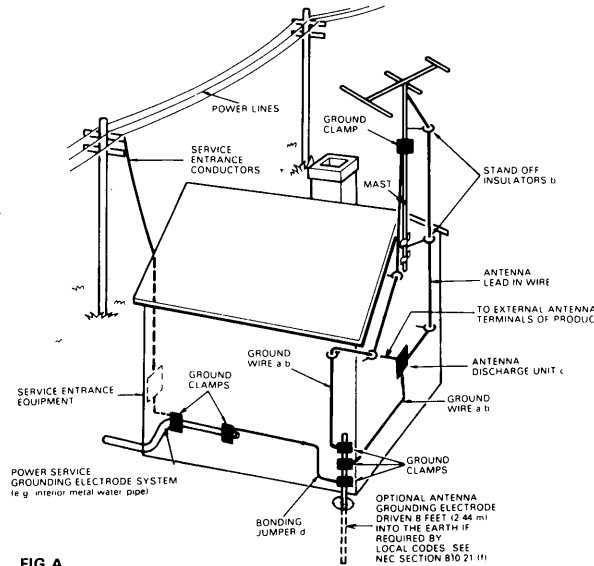

- Use No. 10 AWG (5.3 mm²) copper, No. 8 AWG (8.4 mm²) aluminum, No. 17 AWG (1.0 mm²) copper-clad steel, bronze wire, or larger as ground wire.
- Secure antenna lead-in and ground wires to house with stand-off insulators spaced from 4 feet (1.22 meters) to 6 feet (1.83 meters) apart.
- Mount antenna discharge unit as closely as possible to where lead-in enters house.
- Use jumper wire not smaller than No. 6 AWG (13.3 mm²) copper or equivalent when separate antenna-grounding electrode is used.

FIG. A

IMPORTANT 1



The lightning flash with arrowhead, within an equilateral triangle, is intended to alert the user of the presence of uninsulated "dangerous voltage" within the product's enclosure that may be of sufficient magnitude to constitute a risk of electric shock to persons.

CAUTION
RISK OF ELECTRIC SHOCK
DO NOT OPEN

CAUTION:
TO PREVENT THE RISK OF ELECTRIC SHOCK, DO NOT REMOVE COVER (OR BACK). NO USER-SERVICEABLE PARTS INSIDE. REFER SERVICING TO QUALIFIED SERVICE PERSONNEL.



The exclamation point within an equilateral triangle is intended to alert the user of the presence of important operating and maintenance (servicing) instructions in the literature accompanying the appliance.

IMPORTANT 2

If the apparatus is fitted with AC mains power outlet(s), see REAR PANEL FACILITIES for convenient connection of additional Hi-Fi component(s). Make all connections to the AC outlet(s) and the signal terminals first. Connect the plug to the wall socket last, make sure that the power switch is off. Disconnect the wall plug when the equipment is not in (regular) use, e.g. when on vacation.

FOR USE IN THE UNITED KINGDOM

The wires in this mains lead are coloured in accordance with the following code:

Blue: Neutral
Brown: Live

As the colours of the wires in the mains lead of this apparatus may not correspond with the coloured marking identifying the terminals in your plug proceed as follows:

The wire which is coloured blue must be connected to the terminal which is marked with the letter N or coloured black.

The wire which is coloured brown must be connected to the terminal which is marked with the letter L or coloured red.

Equipment sold in the U.K. is not supplied with a power plug.

CONTENTS

FEATURES	3	OPERATIONS	8
CONNECTIONS	4	TROUBLESHOOTING	11
PANEL FACILITIES	5	SPECIFICATIONS	12

FEATURES

High Power Output of 50W +50W

**The Newly Developed Non Swithing Circuitry
Guarantees High Quality Sound Reproduction.**

CONNECTIONS

When connecting Pioneer system components, please refer to the operating instructions for the audio rack.

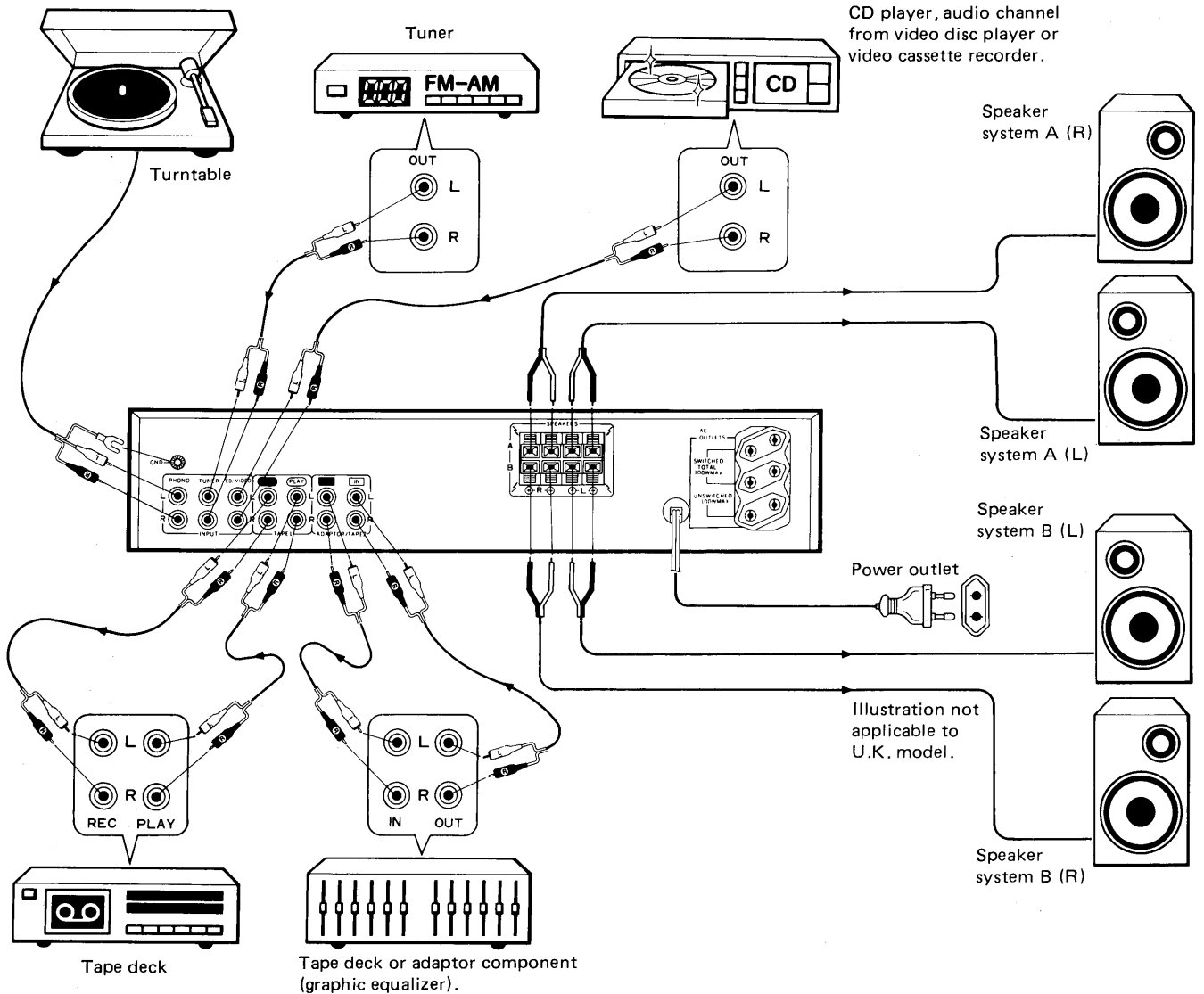

CONNECTING SPEAKER WIRES

- Strip off the vinyl covering and twist the tip of the wire.
- Press the lever, and insert the wire into the hole. Connect \oplus to the speaker's \oplus side, and \ominus to the speaker's \ominus side.

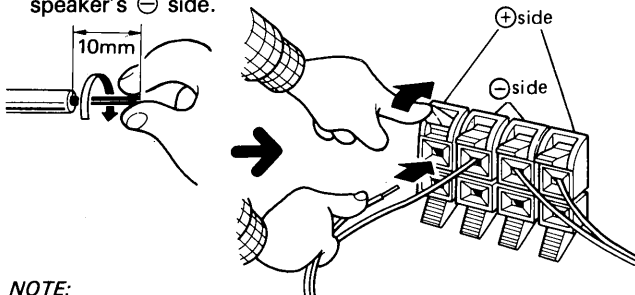

NOTE:

- Remove your finger from the lever and pull the wire gently to check that it is securely connected.
- Do not allow the wire core to protrude and touch other terminals or wires. If the cores of differing wires touch, damage may be caused to your components.

CONNECTING INPUT/OUTPUT CORDS

Connect the white plug to the L (left) side, and the red plug to the R (right) side. Be sure to push the plugs in securely.

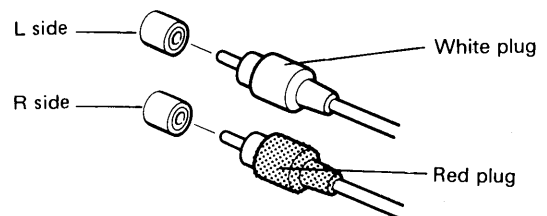

About Speaker Impedance

When speaker systems are connected to only one of the SPEAKERS A, B terminals, such speakers should have rated impedance in the range of 6 – 16 ohms.

PANEL FACILITIES

FRONT PANEL

Indications on the actual unit may differ from those in the illustration. However, operating procedures are the same.

POWER switch

Press to turn power to the unit ON and OFF.

PHONES jack

When using headphones, insert their plug into this jack.

TREBLE tone control

Use to adjust the high-frequency tone.

The central "0" position is the flat (normal) position. When moved to the right, high-frequency tones are emphasized; when moved to the left, high-frequency tones are de-emphasized.

BASS tone control

Use to adjust the low-frequency tone. The central "0" position is the flat (normal) position. When moved to the right, low-frequency tones are emphasized; when moved to the left, low-frequency tones are de-emphasized.

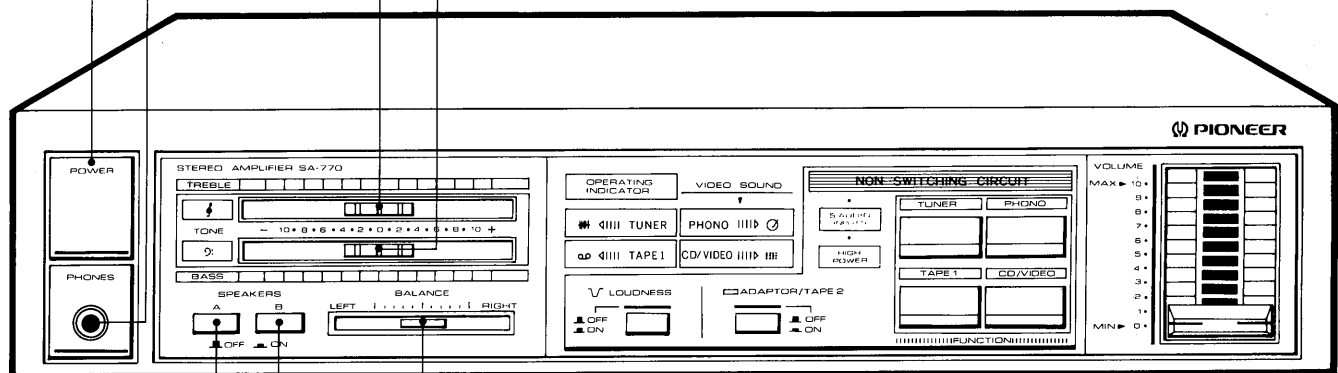

SPEAKERS A selector switch

Use this switch to listen to the speaker systems connected to the SPEAKERS A terminals.

[ON] — Depressed position: Sound is heard from speaker systems.

[OFF] — Released position: No sound is heard from speaker systems. Set to this position when listening with headphones.

BALANCE control

Should normally be left in the center position. Adjust balance if the sound is louder from one of the speakers. If the right side is louder, move toward the LEFT position and if the left side is louder, move toward the RIGHT position.

SPEAKERS B selector switch

Use this switch to listen to the speaker systems connected to the SPEAKERS B terminals.

[ON] — Depressed position: Sound is heard from the speaker systems.

[OFF] — Released position: No sound is heard from the speaker systems. Set to this position when listening with headphones.

NOTE:

When the speaker system is connected to only one speaker terminal (A or B) and both A and B selector switches are ON, there will be no sound. Turn ON only the selector to which the speaker system is connected.

PANEL FACILITIES

Indicators

The indicators light to show the positions of the FUNCTION switches.

LOUDNESS switch

Use when listening at low volume levels.

[OFF] — Released position: Should normally be left in this position.

[ON] — Depressed position: Boosts low and high frequencies to give added punch to playback even at low volume.

FUNCTION switches

Use to select playback source.

[PHONO] — Press when listening to record playback on a turntable.

[TUNER] — Press when listening to AM or FM broadcasts with a tuner.

[CD/VIDEO] — Press when listening to programs from a component connected to the CD/VIDEO terminals.

[TAPE 1] — Press when listening to tape playback with a tape deck.

NOTE:

Function switches should be pressed firmly; otherwise, all the function indicators will light, and no output will be produced. If this occurs, press the desired function switch again.

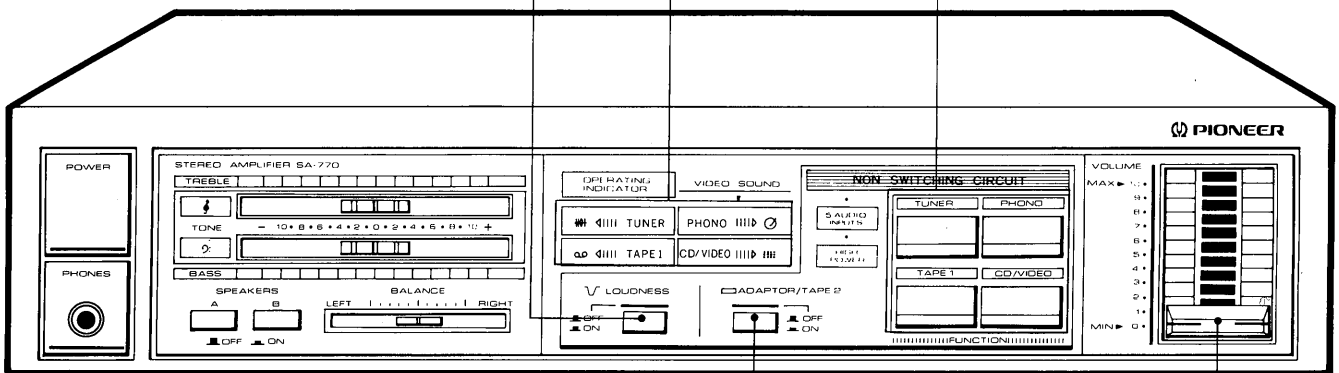

ADAPTOR/TAPE 2 switch/indicator

Use when there is an adaptor component (graphic equalizer, etc.) or tape deck connected to the ADAPTOR/TAPE 2 terminals.

[OFF] — Released position: When not in use.

[ON] — Depressed position: When using the adaptor component or listening to the tape deck.

NOTE:

When no connections are made to the ADAPTOR/TAPE 2 terminals, or when they are not in use, be sure to set this switch to the OFF position. (No sound will be heard if it is set to the ON position.)

VOLUME control

Use to adjust volume level.

Move up to increase volume.

Move down to lower volume.

REAR PANEL

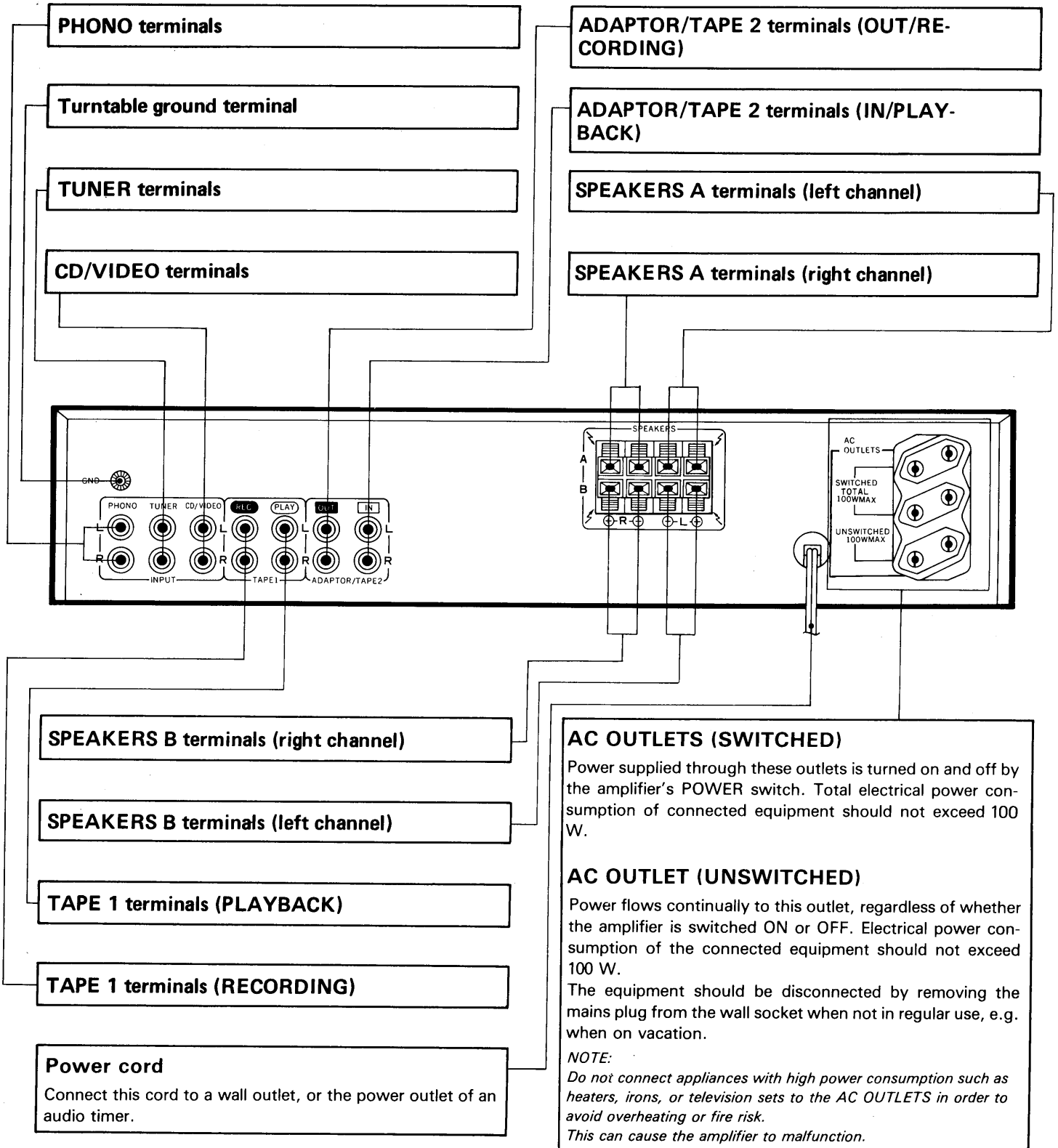

OPERATIONS

BEFORE BEGINNING OPERATIONS

Set the controls and switches as follows:

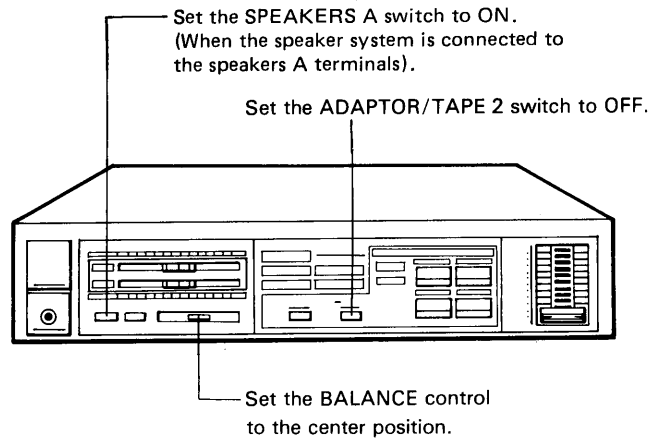

OPERATION PROCEDURES

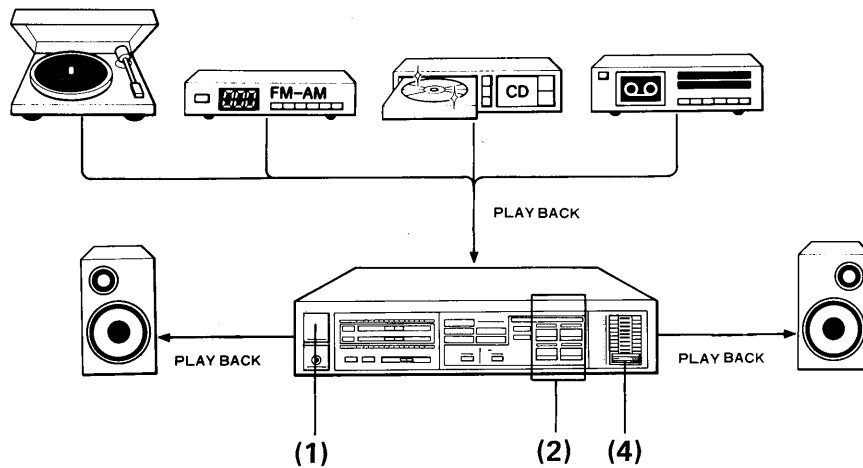

(1) Turn on power to this unit and to the other equipment to be used.

(2) Press the FUNCTION switch

Use to select playback source.

- When listening to a record: Press [PHONO].
- When listening to an AM or FM broadcast: Press [TUNER].
- When listening to a tape: Press [TAPE 1].
- When listening to programs from equipment connected to the CD/VIDEO terminals: Press [CD/VIDEO]

(3) Operate equipment to begin playback.

(4) Adjust playback volume with the VOLUME control on this unit.

RECORDING TAPES:

- While listening to playback on equipment connected to the rear panel terminals, you can record these same sounds on tape merely by setting your tape deck to the recording mode.

- Refer to the operating instructions for your tape deck for proper operating procedures.

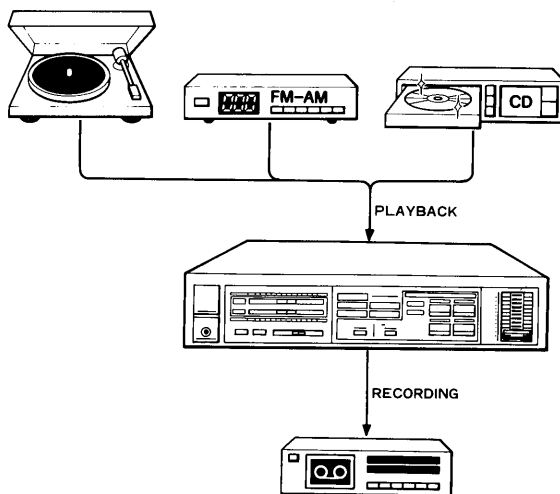

TO USE THE COMPONENT CONNECTED TO THE ADAPTOR/TAPE 2 TERMINALS:

[For an adaptor component]

By connecting a graphic equalizer, source sounds (from records, tapes, AM/FM broadcasts, etc.) can be heard with added sound and tone compensation. Sounds compensated via the adapter component can be recorded.

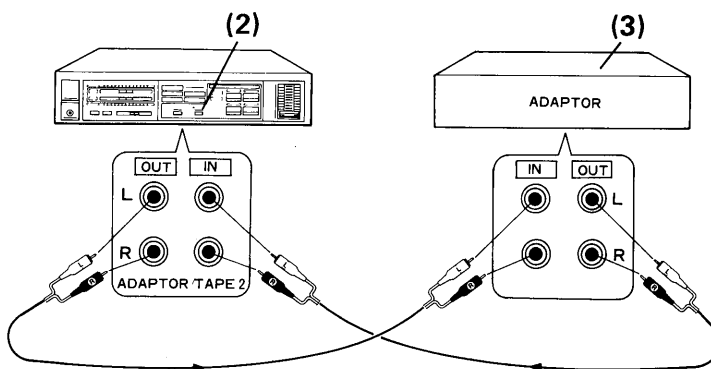

- (1) Play back the source.
- (2) Set the ADAPTOR/TAPE 2 switch to ON.

- (3) Operate the adaptor component.

OPERATIONS

[For a tape deck]

A tape deck connected here can be operated in the same way (recording and playback) as a deck connected to the TAPE 1

terminals. Also, if two decks are used, you can copy tapes from one deck onto the other (see the section "Copying Tapes").

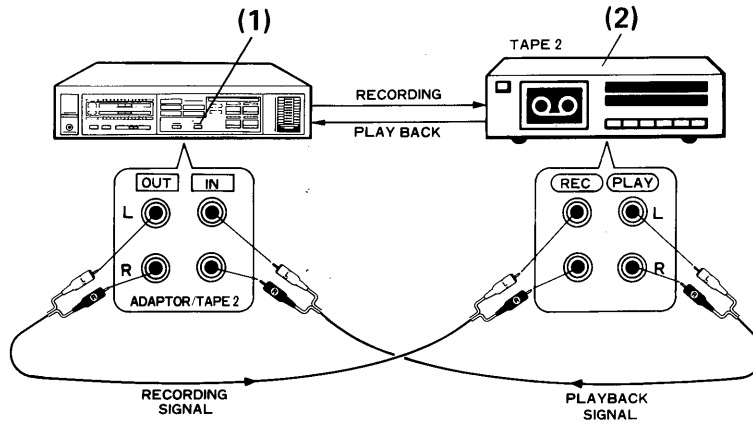

- (1) Set the ADAPTOR/TAPE 2 switch to ON.
- (2) Operate the tape deck to perform playback (or recording).

COPYING TAPES:

When two tape decks (or a double cassette deck) are used, you can record the sounds from one deck onto the other.

Application examples:

- To make a tape copy with contents identical to the original tape.

- To edit a recording of an FM broadcast in order to cut out unwanted commercials, recording only desired material onto another tape.

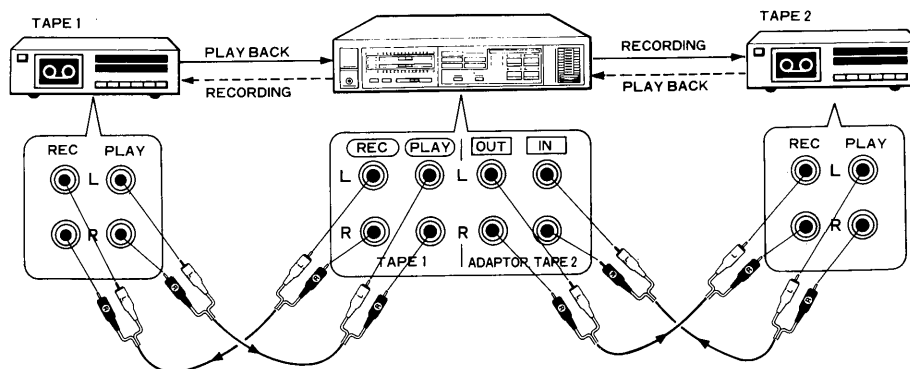

[When using two tape decks]

- (1) Load tapes for playback (pre-recorded tape) and recording (non-recorded tape) into the respective tape decks.
- (2) Select the proper function switch.
 - To copy from the tape deck connected to TAPE 1 terminals to the deck connected to the ADAPTOR/TAPE 2 terminals Press TAPE 1.

- To copy from the tape deck connected to the ADAPTOR/TAPE 2 terminals to the deck connected to the TAPE 1 terminals Set to any function other than TAPE 1, and set the ADAPTOR/TAPE 2 switch to ON.

- (3) Operate the tape decks to begin copying.
 - Set the tape deck with the original (playback) tape to the playback mode, and set the tape deck with the non-recorded tape to the recording mode.

TROUBLESHOOTING

Incorrect operations are often mistaken for trouble and malfunctions. If you think that there is something wrong with this component, check out the points below. Sometimes the trouble may lie in another component. Investigate the other components and electrical appliances being used.

If the trouble cannot be rectified even after exercising the checks listed below, ask your nearest PIONEER authorized service center or your dealer to carry out repair work.

Symptom	Probable Cause	Remedy
No power supplied to unit	<ul style="list-style-type: none"> • Power plug is disconnected from outlet. • The component's power plug has been plugged into another component's power outlet (e.g. timer, etc.), but power to that unit is disconnected. 	<ul style="list-style-type: none"> • Insert plug securely in outlet. • Turn on power to other component.
No sound	<ul style="list-style-type: none"> • Connecting cords are disconnected from terminals, or connected incorrectly. • Terminals or connecting cords' pin plugs are dirty. • The ADAPTOR/TAPE 2 switch is set to ON (except when using an adaptor component). • The function switch selected does not match the component being played back. • Operation of other components is mistaken. • Set the speaker selector switch to "OFF". 	<ul style="list-style-type: none"> • Connect securely. • Clean terminals and plugs. • Set switch to OFF. • Set switches correctly (PHONO, TUNER, CD/VIDEO, TAPE 1). • Consult the operating instructions for the other components. • Set the switch to "ON".
No sound from one speaker	<ul style="list-style-type: none"> • Connecting cords or speaker wires are disconnected to that side. • BALANCE control have been adjusted to one side. 	<ul style="list-style-type: none"> • Connect securely. • Adjust BALANCE control to center position.
Can't record tapes	<ul style="list-style-type: none"> • Connections are mistaken. • Operation of tape deck is mistaken. 	<ul style="list-style-type: none"> • Re-connect properly. • Consult the operating instructions for the tape deck.
Can't perform tape copying	<ul style="list-style-type: none"> • The positions of the TAPE 1 switch and ADAPTOR/TAPE 2 switch are mistaken (when using 2 tape decks). • Operation of tape decks is mistaken. 	<ul style="list-style-type: none"> • Set switches correctly (see section "Copying Tapes"). • Consult the operating instructions for the tape decks.

SPECIFICATIONS

Amplifier Section

Continuous average power output is 50 watts* per channel, min., at 8 ohms from 20 Hertz to 20,000 Hertz with no more than 0.2% total harmonic distortion.

Continuous Power Output (both channels driven)

T.H.D. 0.2%, 1 kHz, 8 Ω 60 W per channel

T.H.D. 0.2%, 20 Hz to 20 kHz, 8 Ω 50 W per channel

DIN, Continuous Power Output at 1 kHz (both channels driven)

T.H.D. 1%, 1 kHz, 8 Ω 62 W per channel

Input (Sensitivity/Impedance)

PHONO 2.5 mV/50 k Ω

TUNER, CD/VIDEO, TAPE PLAY

ADAPTOR IN 150 mV/50 k Ω

Phono Overload Level (T.H.D. 0.01%, 1 kHz)

..... 150 mV

Output (Level/Impedance)

TAPE REC, ADAPTOR OUT 150 mV/2.2 k Ω

Headphone 67 mV/8 Ω

Frequency Response

PHONO (RIAA Equalization)

..... 20 Hz to 20 kHz \pm 0.5 dB

TUNER, CD/VIDEO, ADAPTOR IN, TAPE PLAY

..... 10 Hz to 70 kHz \pm 3 dB

Tone Control

BASS \pm 10 dB (100 Hz)

TREBLE \pm 10 dB (10 kHz)

Loudness Contour (Volume control set at -40 dB position)

100 Hz +6 dB

10 kHz +3 dB

Hum and Noise (IHF, short circuited, A network)

PHONO 72 dB

CD/VIDEO, ADAPTOR IN, TUNER,

TAPE PLAY 102 dB

Hum and Noise (DIN, continuous power /50 mW)

PHONO 68 dB/60 dB

CD/VIDEO, ADAPTOR IN, TUNER,

TAPE PLAY 84 dB/62 dB

Speaker Load Impedance

A or B 6 - 16 Ω

A + B 6 - 16 Ω

Miscellaneous

Power Requirements

European model a.c. 220 V \sim , 50/60 Hz

U.K., Australian models a.c. 240 V \sim , 50/60 Hz

Canadian models AC 120V, 60 Hz

Other destination models \sim AC 110 V/120 V/
220 V/240 V (switchable), 50/60 Hz

Power Consumption

European, U.K., Australian models 400 W

Canadian model 290 VA (CSA)

Other destination models 140 W

Dimensions 420 (W) x 98 (H) x 273 (D) mm

16-1/2 (W) x 3-7/8 (H) x 10-3/4 (D) in

Weight (without package) 5.6 kg (12 lb 6 oz)

Furnished Parts

Operating Instructions 1

NOTE:

- Specifications and design subject to possible modification without notice due to improvements.
- *Measured pursuant to the Federal Trade Commission's Trade Regulation rule on Power Claims for Amplifier.

PIONEER ELECTRONIC CORPORATION 4-1, Meguro 1-Chome, Meguro-ku, Tokyo 153, Japan
PIONEER ELECTRONICS [USA] INC. 5000 Airport Plaza Drive P.O. Box 1720, Long Beach, California
90801-1720 U.S.A.

PIONEER ELECTRONIC [EUROPE] N.V. Keetberglaan 1, 2740 Beveren, Belgium TEL: 03/775-28-08
PIONEER ELECTRONICS AUSTRALIA PTY. LTD. 17B-184 Boundary Road, Braeside, Victoria 3195, Australia
TEL: (03) 580-9911