

Miller

BAND PASS TUNED RADIO FREQUENCY COIL KIT FOR TRUE FIDELITY

In almost every issue of radio trade publications we are impressed with the fact that this product or that product has been designed for "high fidelity," but just what is high fidelity? As applied to radio or sound equipment, high fidelity is the reproduction of sound waves which are first converted into electrical impulses and then reconverted into sound waves of greater intensity and, in the case of radio broadcasts, at some distance from the original source, all of this being done with a minimum change in the character of the sound waves by the conversion process. True fidelity would be an exact reproduction of the original sound waves, but we have not yet attained this state of perfection.

The development of high fidelity equipment for use in broadcasting and sound amplifier work has progressed far beyond the degree of perfection obtainable in the radio frequency circuits of the commercially available receivers. Reception of high fidelity programs is satisfactory only from local broadcast stations, and therefore it is not necessary that the receiver have a high degree of sensitivity. The inherent receiver noises should be kept as low as possible, and this requirement seems to indicate a TRF circuit rather than a superheterodyne circuit. The TRF circuit has the further advantage of being much simpler in construction and maintaining correct adjustment over longer periods of time. Experiments

have shown that a flat-top band width of approximately 20 KC is satisfactory for all practical purposes. With this band width, the resonance curve should have a very steep slope in order to avoid interference from stations on nearby channels. This may be accomplished by using coils having a high Q in a suitable band-pass circuit.

A receiver such as the one to be described will meet the requirements of the sound studio man for monitoring purposes and may be used in making air check recordings and for the discriminating broadcast listener who wishes to hear radio programs as they are broadcast and not as they are received over the average receiver, which sharply attenuates side bands and is equipped with a variety of "tone selector circuits", resulting in sound waves produced by the loud speaker having only a slight resemblance to the original program.

The receiver to be described is a modified version of the tuner designed by William N. Weeden and shown in the February 1937 issue of *ELECTRONICS*, the principle differences being in the addition of an untuned antenna stage, higher Q RF coils, and the use of the 10 KC heterodyne filter in the detector circuit rather than in the first audio amplifier plate circuit.

The complete receiver as described may be constructed at a cost of between \$75.00 and \$90.00. Audio fidelity is remarkably good when we consider that only one speaker is used. Of course, those who wish to do so may go into more elaborate equipment and use theatre type high and low frequency speakers. The several performance graphs shown tell the complete story of the receiver's performance. Note that the design of the RF coils is such as to give an over-all sensitivity that is essentially uniform throughout the tuning range from 540 to 1500 KC. Any substitution of coils other than those specified would severely impair the performance of the receiver.

The component parts used in this receiver design have been selected as being typical of several makes of equally good quality and it is not necessary to adhere strictly to the makes specified except for the radio frequency coils. However, if a different make of transformer is used, it will be necessary to drill the necessary holes in the chassis to accommodate the different mounting requirements, since the punched chassis which is available has been laid out for Thordarson transformers.

The band-pass and RF coils are of the high Q type and have been selected to provide the necessary steep side

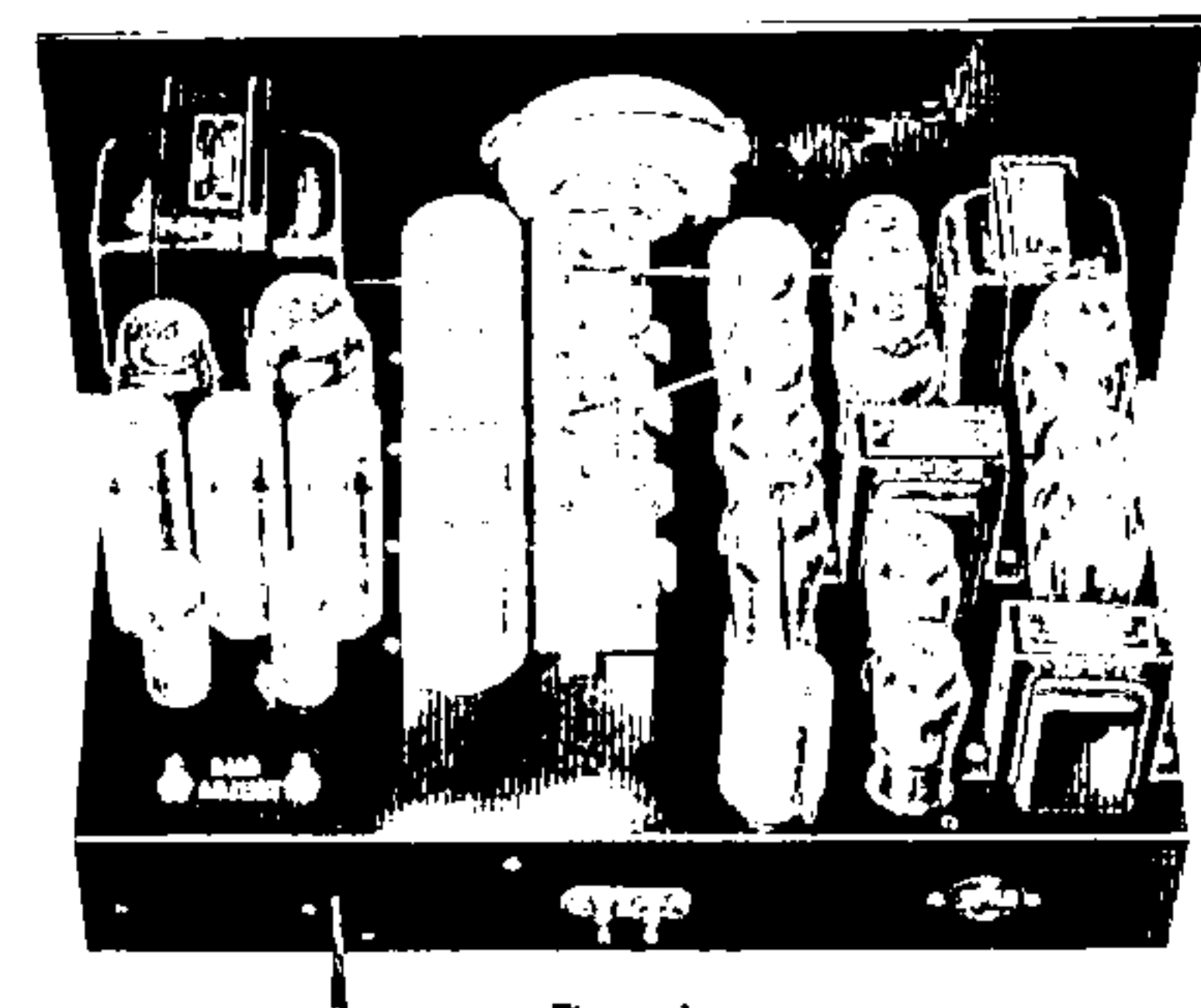

Figure 1



1400 KC
Band Width 20 KC



600 KC
Band Width 23 KC

Figure 2

resonance curve. The correct band-width of approximately 20 KC is obtained by means of the negative mutual coupling coils and the by-pass condensers and resistors in the grid return circuits. If the capacity of the condensers in the coupling circuits is decreased, the result will be a dip in the center of the response curve, and a decrease in capacity will tend to widen the band-width.

Undoubtedly a number of readers will wish to build only the radio frequency portion of the receiver. In this connection it must be pointed out that the best results will be obtained only when the layout of parts exactly follows that shown.

The alignment of the RF circuits of the receiver is a relatively simple procedure, and while it would be desirable to use an oscilloscope, it is not essential to do so. The cathode ray tuning indicator may be used to indicate resonance in making the alignment. When properly aligned, the "eye" shadow angle should remain stationary for approximately 20 KC while tuning through resonance. Variation of the "eye" shadow angle is an indication of incorrect adjustment of the RF trimmers. A slight variation is, of course, permissible. The RF coils are held to very close inductance tolerances, and unless the physical layout has been altered from that specified, the only balancing necessary will be the adjustment of the trimmers on the variable condenser at approximately 1400 KC. Should any further adjustment be needed, it may be done by slightly bending the rotor plates of the variable condenser.

RECEIVER ASSEMBLY AND WIRING

Before starting to wire the receiver, the following parts should be attached to the chassis. See Fig. 1, 3, 4, and 5.

Tube Sockets, Power Transformer, Filter Condensers, Bias Potentiometers and Bias Resistors, Audio Transformers, No. 1540 Filament Tie Point, No. 1550 Output Transformer Sec. Tie Point, No. 1510 AC Cord Tie Point.

NOTE: A solder lug for grounding is to be fastened under one mounting bolt for each of the following sockets: 83 Rectifier, Push-Pull 76 Stage, and Diode 76.

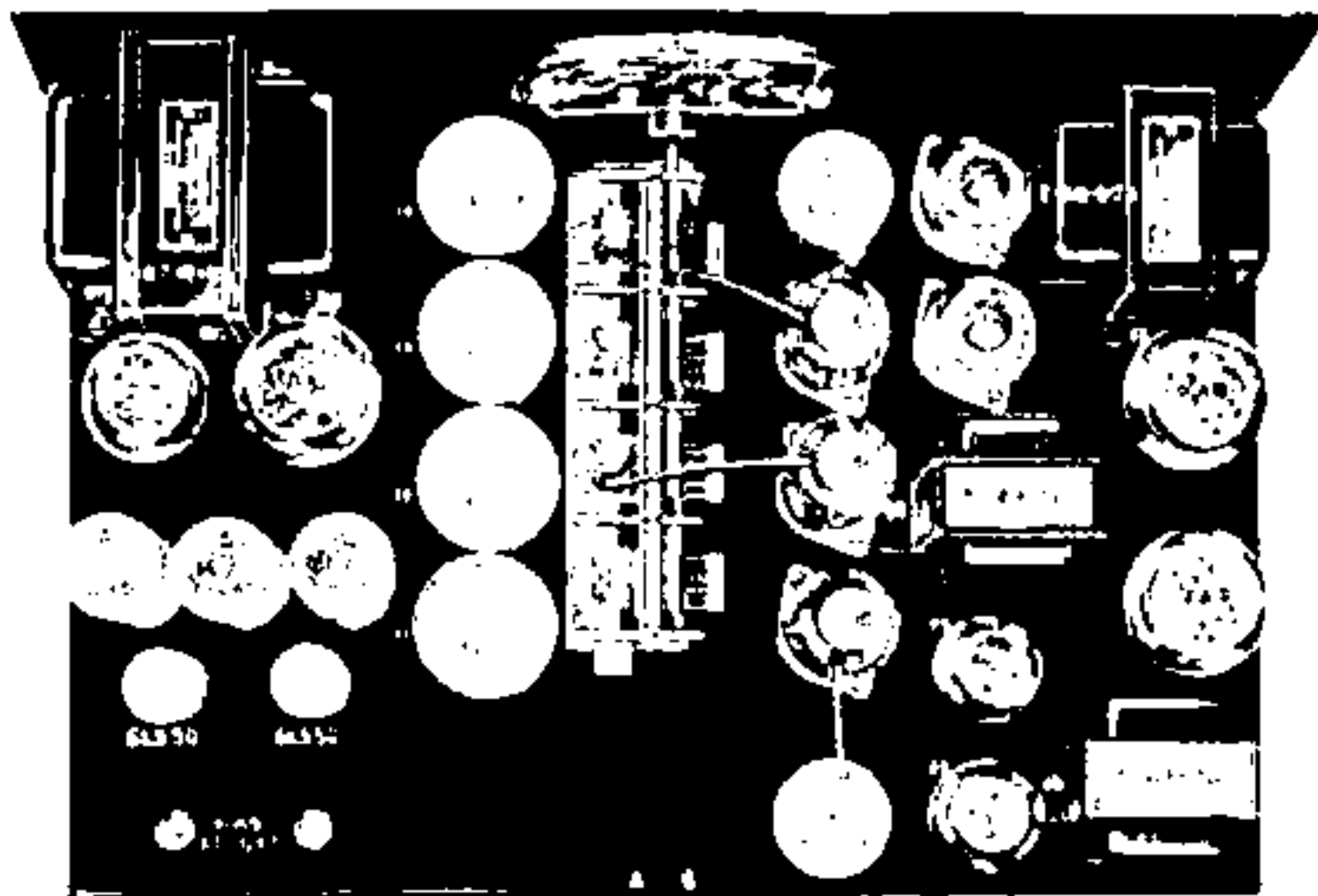

Figure 3

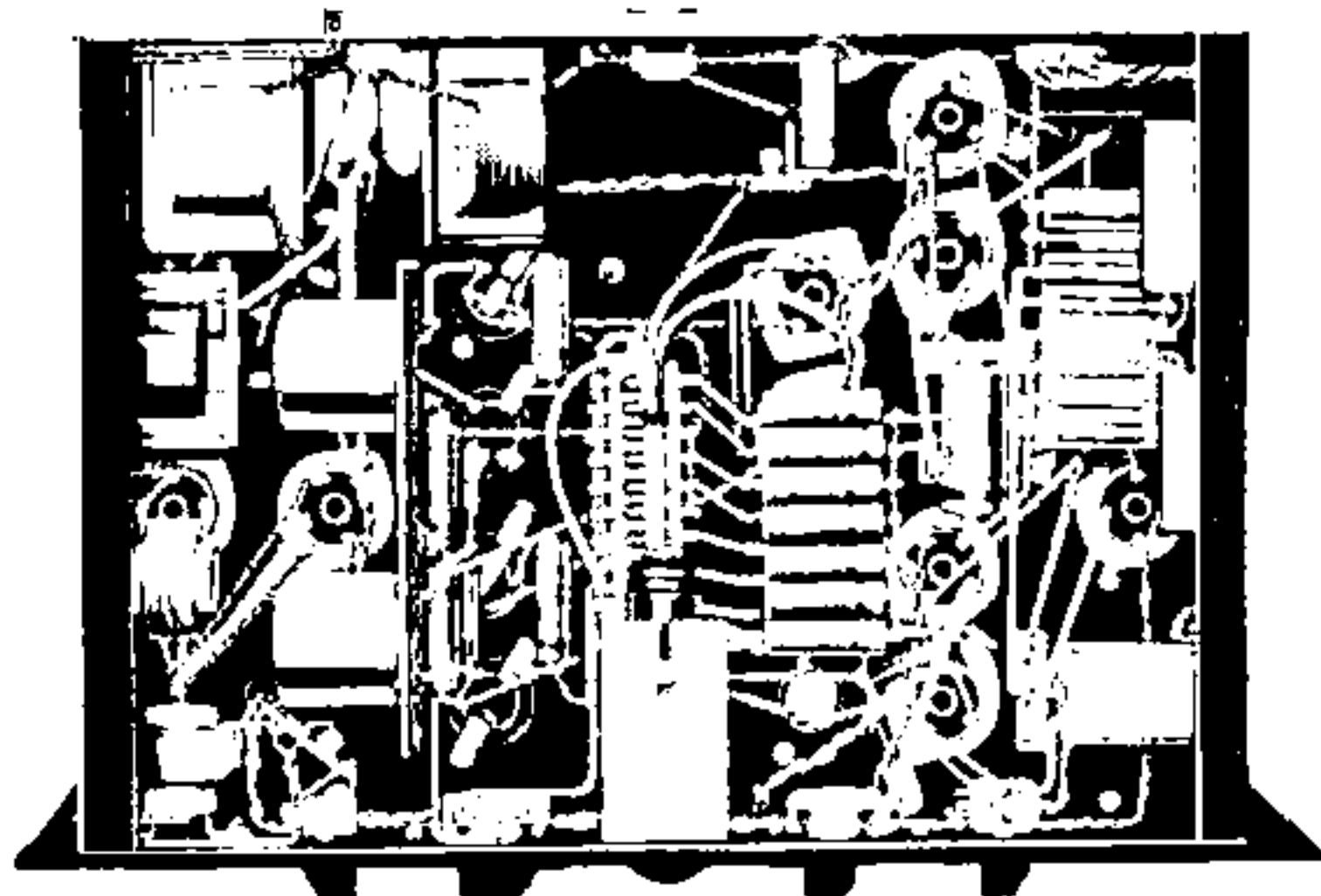

Figure 4

Lock washers should be used with all mounting bolts so that each part will be properly grounded to the chassis. When the bolts are tightened, the lock washers will bite into the steel of the chassis.

First, wire the power transformer and filament leads. The center taps of the 2.5 volt and the 6.3 volt filament windings and the high voltage winding should be grounded to the solder lug on the 83 rectifier tube socket.

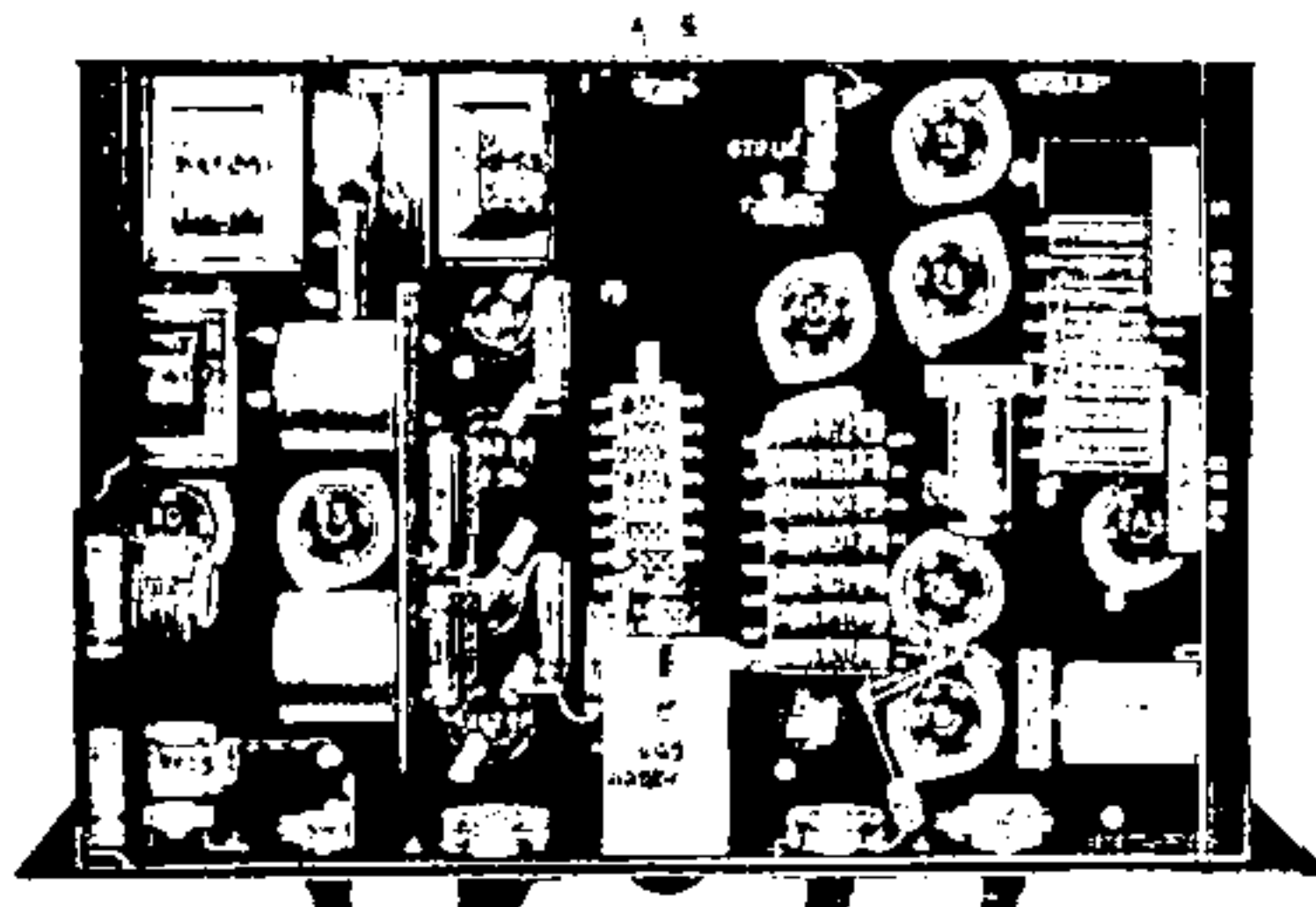

Figure 5

The filament wires from the tube sockets should be twisted to reduce hum pickup and run across the front of the chassis to the No. 1540 filament lead tie point mounted under the power transformer. The wires for the dial lights are connected to the filament terminals of the detector socket. Use No. 18 gauge or larger wire for the filament circuits.

The bias supply choke may now be bolted to the chassis and the wiring of the bias circuit completed. Connect a pair of twisted leads from the arm of each bias potentiometer to a No. 1520 tie point fastened under the mounting bolt of the push-pull driver transformer.

After carefully checking all wiring so far completed, the high voltage filter chokes should be bolted in place and the high voltage filter circuit wired, using two No. 1510 tie points attached under the mounting bolts of one choke for the junctions of the choke and filter condenser leads.

The resistors and condensers should now be assembled to the three terminal boards as shown in Fig. 5. The audio circuit and the leads to the output socket should now be wired using the No. 1550 tie point, which is attached to the end of the chassis below the output transformer. The common terminal of the output trans-

former should be grounded. The voltage divider resistor terminal board should now be attached as shown and wired.

Next, assemble the RF coils and the variable condenser and dial. Grid and ground leads should first be wired to each section of the variable condenser. The dial light sockets should now be wired.

The plate and grid leads to the RF coils and the untuned RF and detector circuits should now be wired. Three inch leads should be wired to the screen grid and cathode-suppressor grid socket terminals of the RF tubes. Attach the antenna-ground terminal strip and the series .0001 mfd. condenser and wire the antenna terminal to the antenna coil using a shielded lead with the shield braid grounded to the ground terminal of the A-G strip and a lug under one of the antenna coil mounting bolts. The next operation is to attach and wire the remaining terminal boards. Assembly and wiring of the negative-mutual coupling coils in their shields on the coil mounting bracket will then complete all wiring in the RF circuit. See Fig. 4 for position of essential wires.

The 10 KC filter No. EL-58 and the front panel controls should now be attached and wired.

While the "magic eye" is shown assembled under the chassis, it may, if desired, be attached to the variable condenser so that it will be above instead of below the tuning dial. In either case, the wiring of the magic eye will complete the wiring of the receiver.

Check all connections and solder joints as the wiring progresses. Refer to Fig. 4 and 5 showing the underside of the chassis for the correct position of all parts. While it may not be necessary that the parts be laid out exactly as shown, it is recommended that no change in layout be made in order to insure the correct performance as obtained in the original model. This is particularly true of the RF circuits where any changes may result in improper coupling and poor operation of the band-pass stages. The presence of any regeneration in the RF circuit will alter the shape of the band-pass curve.

After putting the receiver in operation, check the circuits carefully with a voltmeter and compare the readings with the values shown in the schematic circuit diagram. Slight variations will not cause any appreciable change in performance.

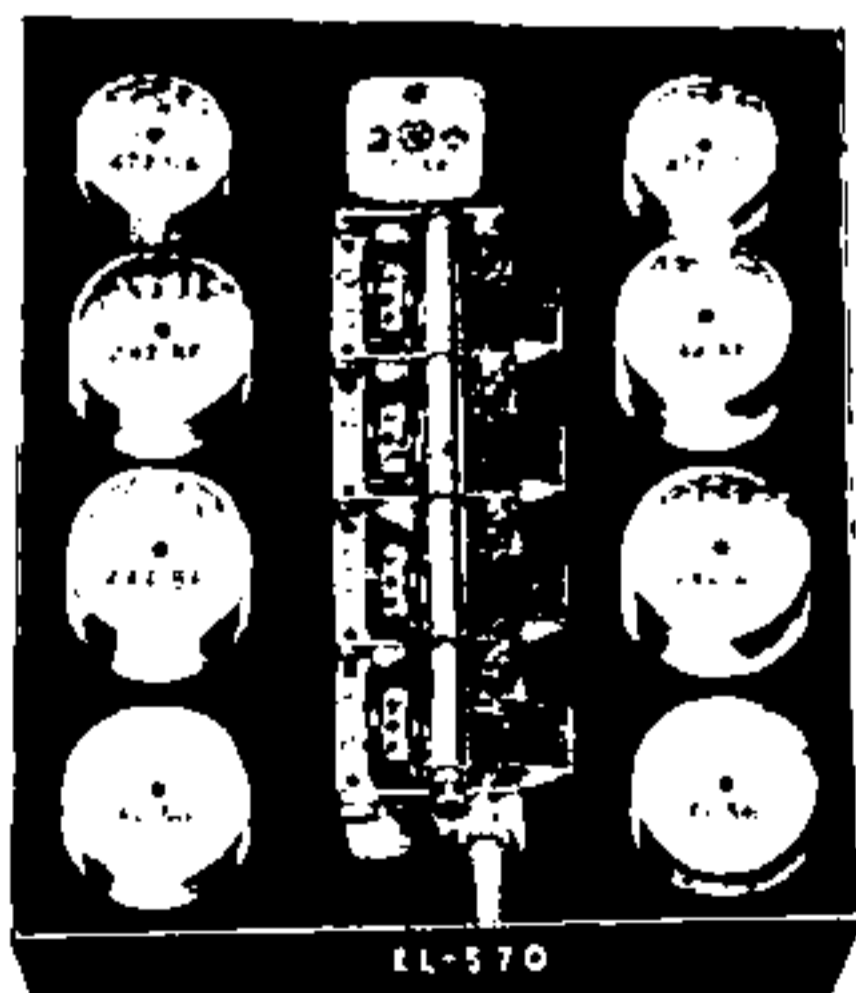

MILLER No. EL-570 Coil Kit:

1 No. 472-UA	Untuned Antenna Coil
2 No. 242-RF	Bank-Wound RF Coils
2 No. 242-BP	Bank-Wound Band-Pass Coils
1 No. 472-UT	Untuned Detector Coil
2 No. EL-56	Negative Mutual Coup. Coils
1 No. EL-58	10 KC Audio Filter
1 No. 2104	4-Gang Variable Condenser
1 No. EL-570	Circuit Diagram Blue Print



CHASSIS AND PANEL

The chassis listed below are constructed of spot-welded, die-formed and punched 18 gauge deep-drawing cold-rolled steel and are finished in a durable black baked enamel. The front panel is made from 12 gauge steel and is finished in baked Kem-Art black crystalline enamel.

No. 570-R	Receiver Chassis Dimensions	18"x12"x3 1/2"
No. 570-T	Tuner Chassis Dimensions	14"x10"x3 1/2"
No. 570-TB	Tuner Chassis Drawn Bottom Plate Dimensions	14"x10"x 1/2"
No. 570-P	Front Panel Dimensions	19"x10 1/2"x12 ga

COMPLETE RECEIVER PARTS LIST

J. W. MILLER COMPANY		List Price
1 No. EL-570	COIL KIT	\$18.00
1 No. 570-R	Receiver Chassis	7.50
1 No. 150	Dial with Escutcheon	3.75
1 No. 570-P	Chassis Front Panel	2.50
2 No. 7825	Line Filter Chokes @ 1.00	2.00
2 No. 450	Terminal Plates @ .30	.60
1 No. 440	Terminal Plate35
10 No. 1510	Tie Points02 1/2	.25
3 No. 1520	Tie Points03	.09
1 No. 1550	Tie Point07
1 No. 1540	Tie Point06
1 Pr. No. 570 EP	Engraved Name Plates	2.50

AEROVOX CORPORATION

1 No. GL-450	8 Mid. Filter Condenser
2 No. 2GL-450	16 Mid. Filter Condensers
2 No. GLS-450	8 Mid. Filter Condensers
1 No. PBS-5	8-8 Mid. Filter Condenser
1 No. PB-25	25 Mid. Filter Condenser
12 No. 484	.1 Mid. By-Pass Condensers
5 No. 484	.05 Mid. By-Pass Condensers
3 No. .0001	Mid. Mica Condensers

AMERICAN PHENOLIC CORPORATION (Amphenol)

1 No. MEA-8	Magic Eye Assembly
4 No. RS-4	4 Prong Sockets
4 No. RS-5	5 Prong Sockets
3 No. RS-6	6 Prong Sockets
1 No. PM-5	5 Prong Plug

ARROW ELECTRIC COMPANY

1 No. SPST	Rotary Switch
1 No. DPDT	Rotary Switch

GOAT RADIO TUBE PARTS

5 Tube Shields

HYGRADE SYLVANIA CORPORATION

4 Type 78	Tubes
3 Type 6D6	Tubes
2 Type 2A3	Tubes
1 Type 83	Tube
1 Type 90	Tube
1 Type 6G5	Tube

INTERNATIONAL RESISTANCE COMPANY (IRC)

1 No. BT-2	2000 Ohm 2 Watt Resistor
1 No. BT-2	10,000 Ohm 2 Watt Resistor
1 No. BT-2	15,000 Ohm 2 Watt Resistor
3 No. BT-1	100,000 Ohm 1 Watt Resistors
1 No. BT-1	40,000 Ohm 1 Watt Resistor
2 No. BT-1	25,000 Ohm 1 Watt Resistors
1 No. BT-1	2500 Ohm 1 Watt Resistor
1 No. BT-1	1250 Ohm 1 Watt Resistor
1 No. BT-1/2	1 Meg Ohm 1/2 Watt Resistor
1 No. BT-1/2	100,000 Ohm 1/2 Watt Resistor
1 No. BT-1/2	20,000 Ohm 1/2 Watt Resistor
3 No. BT-1/2	5000 Ohm 1/2 Watt Resistors
3 No. BT-1/2	1000 Ohm 1/2 Watt Resistors
3 No. BT-1/2	300 Ohm 1/2 Watt Resistors
1 Type AB	3500 Ohm Wire Wound Resistor

JENSEN RADIO MANUFACTURING COMPANY

1 Model KM-12	Type BT-381 Speaker, or
1 Model KM-15	Type BT-385 Speaker

P. R. MALLORY & COMPANY, INC. (Yaxley)

- 1 No. N 500,000 Ohm Volume Control
- 1 No. E 5000 Ohm Volume Control
- 2 No. M3MP 3000 Ohm Potentiometers

THORDARSON ELECTRIC MFG. COMPANY

- 1 No. T-87-R-85 Power Transformer
- 1 No. T-58-S-72 Output Transformer
- 1 No. T-58-A-70 Interstage Transformer
- 1 No. T-74-A-31 Input Transformer
- 2 No. T-57-C-53 Filter Chokes
- 1 No. T-18-C-82 Filter Choke

TUNER ASSEMBLY

Fig. 6 and 7 show top and bottom views, respectively, of the high fidelity tuner only, which may be used in connection with any standard amplifier and speaker system. Note that on the right-hand side of Fig. 6 there is shown in phantom view the arrangement and parts required for a self-contained power supply suitable for operating the tuner only. The power supply is not needed when the amplifier with which the tuner is to be used has available suitable voltages.

The diode detector circuit shown in the No. EL-570 receiver circuit diagram has been carefully designed and has a modulation capability of approximately 95%.

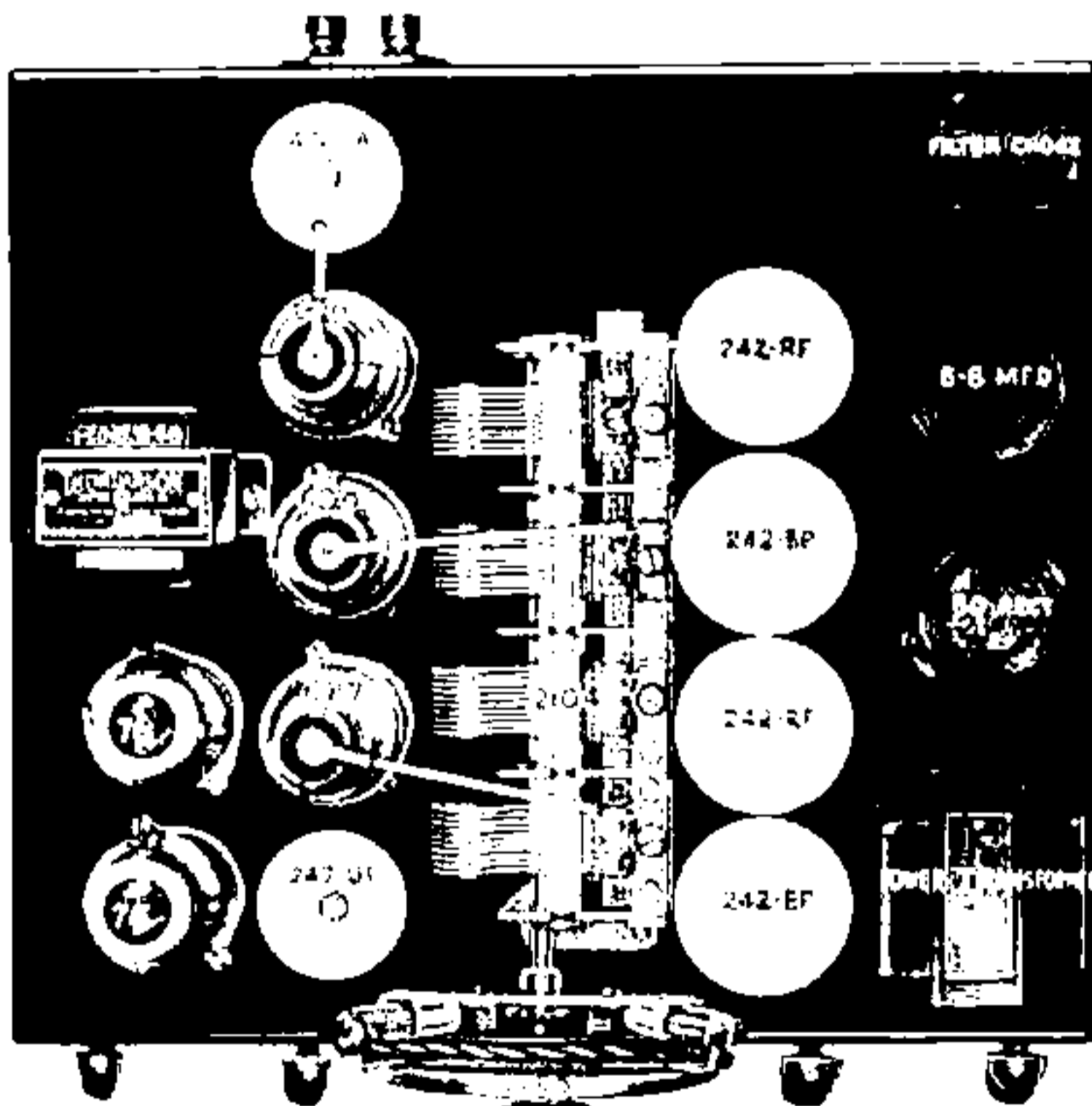

Figure 6

which is more than adequate for the reception of most broadcast signals. Since quite a few broadcast stations are installing "peak limiters" in order to maintain a higher average modulation percentage, a detector circuit having 100% modulation capability is in some cases desirable. The No. EL-570-A tuner circuit diagram is designed for an infinite impedance detector, which has 100% modulation capability.

The infinite impedance detector circuit has the disadvantage of not being capable of providing AVC voltage. AVC voltage may be obtained, as shown in print No. EL-570-A, by the use of a type 6B7 tube in the third RF stage in which the diode section of the tube is fed a portion of the RF voltage developed in the plate circuit and utilizing the negative voltage developed across the 1 megohm diode load resistor. RF voltage is fed to the diode plates through the .00005 mfd. mica condenser connected from plate to diode. Note that the cathode of the 6B7 is operated at fixed bias and is not connected to the RF gain control, as are the other RF tubes. This is necessary in order to avoid excessive

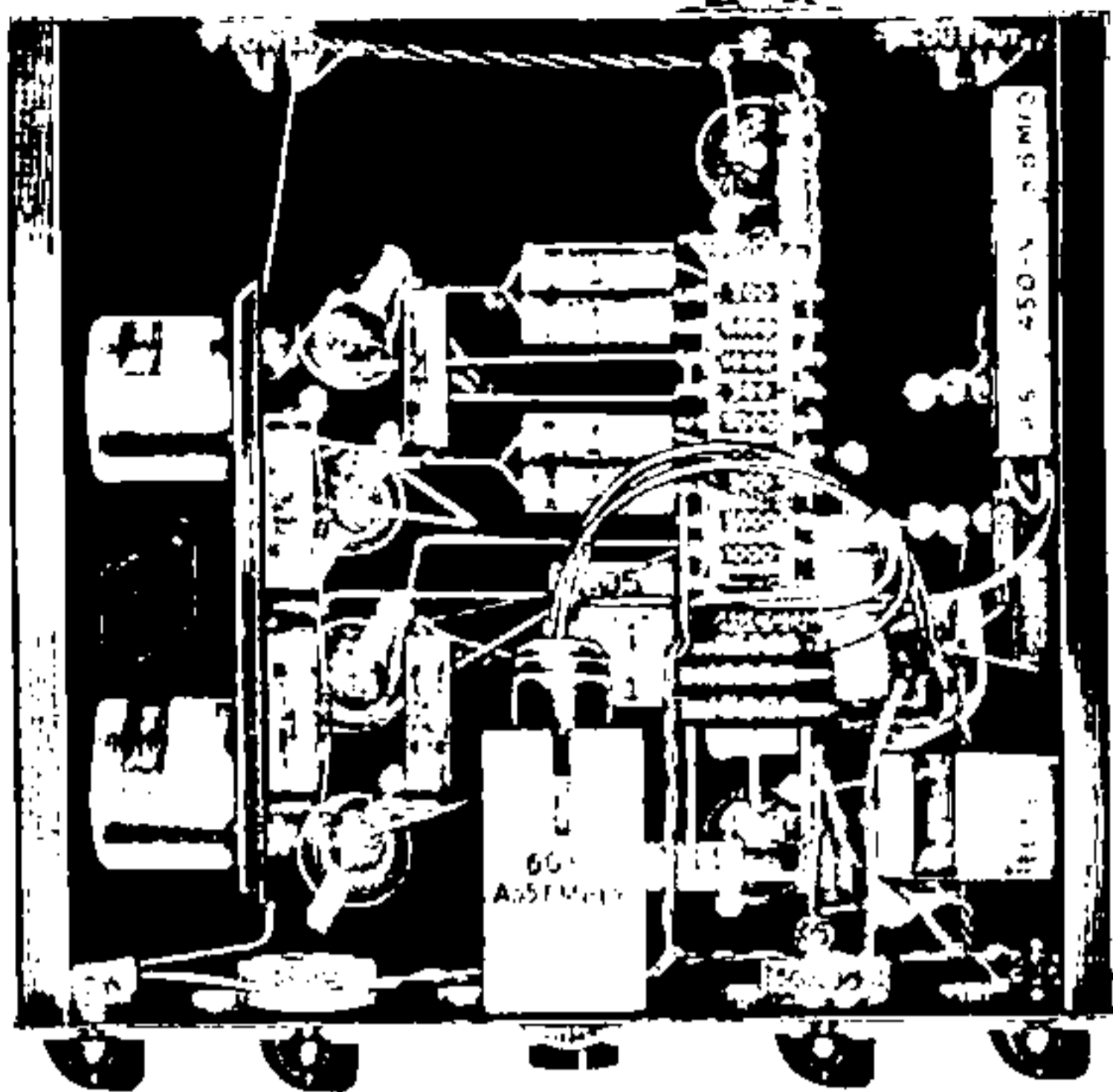

Figure 7

delay action in the AVC circuit. The AVC action thus obtained is not as linear as that obtained from the diode circuit shown in circuit diagram No. EL-570, although it is ample to take care of signal fade from local stations.

Unlike the diode detector, the infinite impedance circuit does not load the secondary of the RF transformer, but instead presents a capacity reactance to the circuit, thus resulting in an increase in sensitivity in the RF circuit.

OPERATING HINTS

An antenna of from 30 to 40 feet in length will be satisfactory for all normal installations. If a doublet antenna system is used, it will be necessary to include a line-to-receiver matching transformer, due to the construction of the untuned antenna coil. Most doublet antenna systems are provided with such a matching transformer.

If the receiver is to be used in or near a broadcast transmitter, it is recommended that the entire unit be enclosed in a suitable metal case to prevent signal energy from getting directly into the detector circuit through the exposed RF wiring. The line filter, consisting of two chokes and two condensers, shown in the primary circuit of the power transformer, effectively prevents signal energy from entering the receiver due to pickup in the AC line.

In general, it is recommended that the audio gain control be operated at or near the maximum position and the volume adjusted to a suitable level by means of the RF gain control. This procedure will avoid any distortion which might result from operating the audio gain control near the minimum position.

Do not expect to separate stations operating within 10 or 20 KC of each other, as the over-all flat-top selectivity of the RF circuit is approximately 20 KC. The side slope of the resonance curve is quite steep (see Fig. 2—untouched oscilloscope photograph) and no interference will be obtained from stations operating 40 to 50 KC apart.

Do not expect to obtain a great deal of DX reception, although the sensitivity of the receiver is sufficiently great to provide daylight reception within a radius of 150 to 200 miles under average low noise level conditions.

The No. EL-58 filter shown in the detector load circuit consists of a parallel resonant circuit using a laminated

iron core coil and a variable mica-dielectric trimmer, which is adjustable from the top of the shield. This filter is normally adjusted to 10,000 cycles and is useful in preventing "monkey chatter" from adjacent channel signals. Refer to the audio frequency amplifier curve for the audio attenuation characteristics of the No. EL-58 filter. The tuning range of the condenser is sufficiently great to enable the filter to be resonated at frequencies as low as 7,000 cycles.

If the receiver is constructed according to the instructions and data given, the results will be a high fidelity receiver of the finest type obtainable to meet the exacting demands of the discriminating radio listener, sound engineer, and air-check recorder.

COMPLETE TUNER PARTS LIST

J. W. MILLER COMPANY

	List Price
1 No. EL-570 Coil Kit	\$15.00
1 No. 570-T Tuner Chassis	5.50
1 No. 150 Dial with Escutcheon	3.75
1 No. 570-P Chassis Front Panel	2.50
1 No. 570-TB Tuner Chassis Bottom Plate	1.00
1 No. 440 Terminal Plate35
5 No. 1510 Tie Points @ .02 1/2	.13
2 No. 1820 Tie Points @ .03	.06
1 Pr. No. 570 EP Engraved Name Plates	2.50

AEROVOX CORPORATION

- 1 No. P-5 450 Volt 8-8 Mfd. Filter Condenser
- 1 No. PB-25 25 Volt 25 Mfd. Filter Condenser
- 11 No. 484 .1 Mfd. By-Pass Condensers
- 4 No. 484 .05 Mfd. By-Pass Condensers
- 4 .0001 Mfd. Mica Condensers
- 1 .00005 Mfd. Mica Condensers

AMERICAN PHENOLIC CORPORATION (Amphenol)

- 1 No. MEA-6 Magic Eye Assembly
- 2 No. RS-4 4 Prong Sockets
- 2 No. RS-5 5 Prong Sockets
- 2 No. RS-8 6 Prong Sockets
- 1 No. RS-7 7 Prong Socket
- 2 No. PM-4 4 Prong Plug

ARROW ELECTRIC COMPANY

- 1 No. SPST Rotary Switch
- 1 No. DPDT Rotary Switch

GOAT RADIO TUBE PARTS

- 5 Tube Shields

HYGRADE SYLVANIA CORPORATION

- 2 Type 6D6 Tubes
- 1 Type 6B7 Tube
- 1 Type 6G5 Tube
- 2 Type 76 Tubes

INTERNATIONAL RESISTANCE CORP. (IRC)

- 1 No. BT-2 20,000 Ohm 2 Watt Resistor
- 1 No. BT-3 15,000 Ohm 2 Watt Resistor
- 1 No. BT-1 20,000 Ohm 1 Watt Resistor
- 1 No. BT-1 40,000 Ohm 1 Watt Resistor
- 1 No. BT-1 2500 Ohm 1 Watt Resistor
- 3 No. BT-1/2 300 Ohm 1/2 Watt Resistors
- 3 No. BT-1/2 1000 Ohm 1/2 Watt Resistors
- 3 No. BT-1/2 5000 Ohm 1/2 Watt Resistors
- 1 No. BT-1/2 10,000 Ohm 1/2 Watt Resistor
- 1 No. BT-1/2 20,000 Ohm 1/2 Watt Resistor
- 4 No. BT-1/2 100,000 Ohm 1/2 Watt Resistors
- 1 No. BT-1/2 500,000 Ohm 1/2 Watt Resistor
- 1 No. BT-1/2 1 Megohm 1/2 Watt Resistor

P. R. MALLORY & COMPANY (Yaxley)

- 1 Type N 500,000 Ohm Volume Control
- 1 No. E 5000 Ohm Volume Control

THORDARSON ELECTRIC MFG. COMPANY

- 1 No. T-82-A-26 Tube-to-Line Transformer

ADDITIONAL PARTS REQUIRED FOR POWER SUPPLY

- 1 AEROVOX No. 2GB-450 8-8 Mfd. Filter Condenser
- 2 AEROVOX No. 484 .1 Mfd. By-Pass Condensers
- 1 AMPHENOL No. RS-4 4 Prong Socket
- 1 SYLVANIA Type 80 Tube
- 1 THORDARSON No. T-70-R-20 Power Transformer
- 1 THORDARSON No. T-68-C-08 Filter Choke

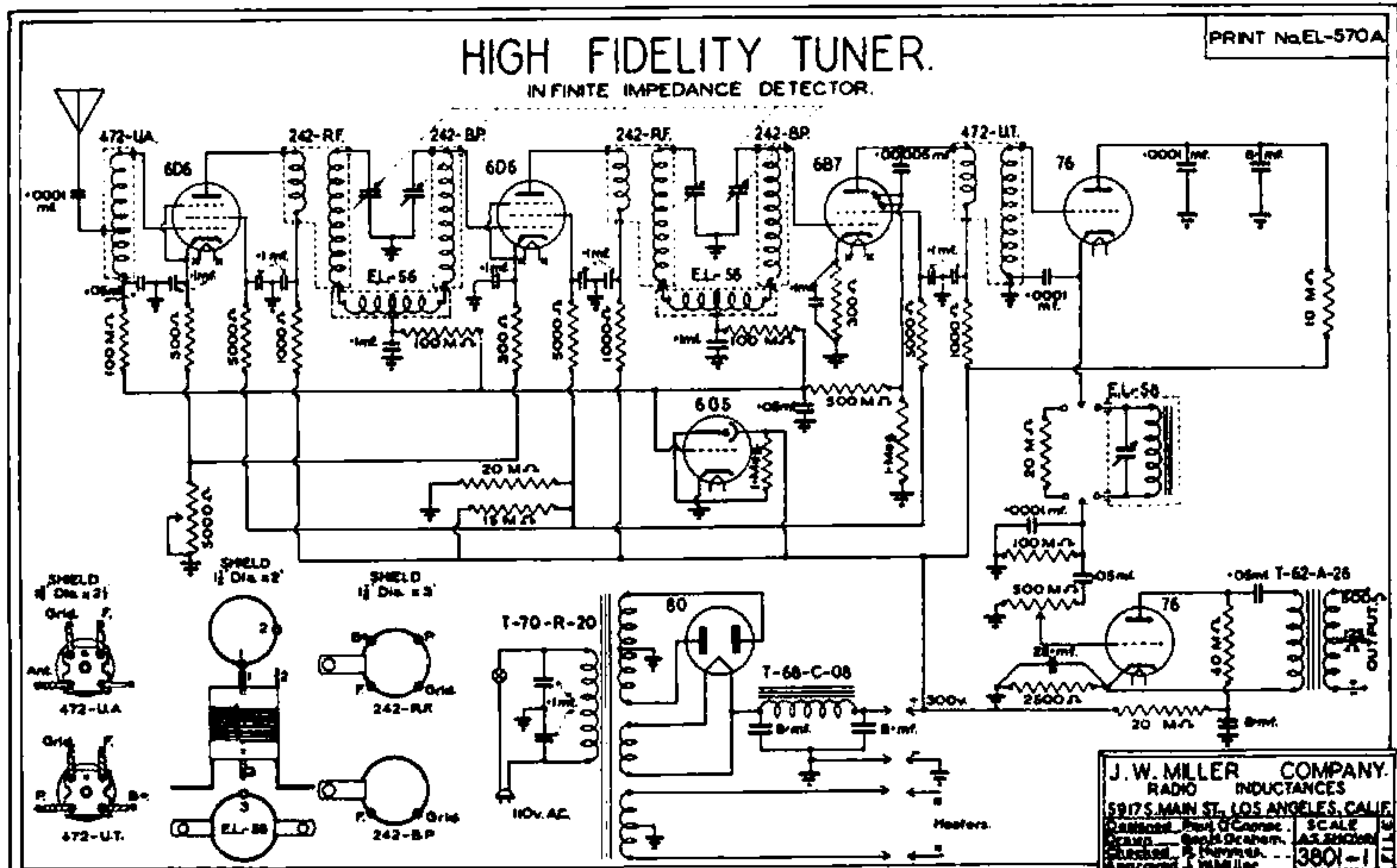

HIGH FIDELITY RECEIVER.

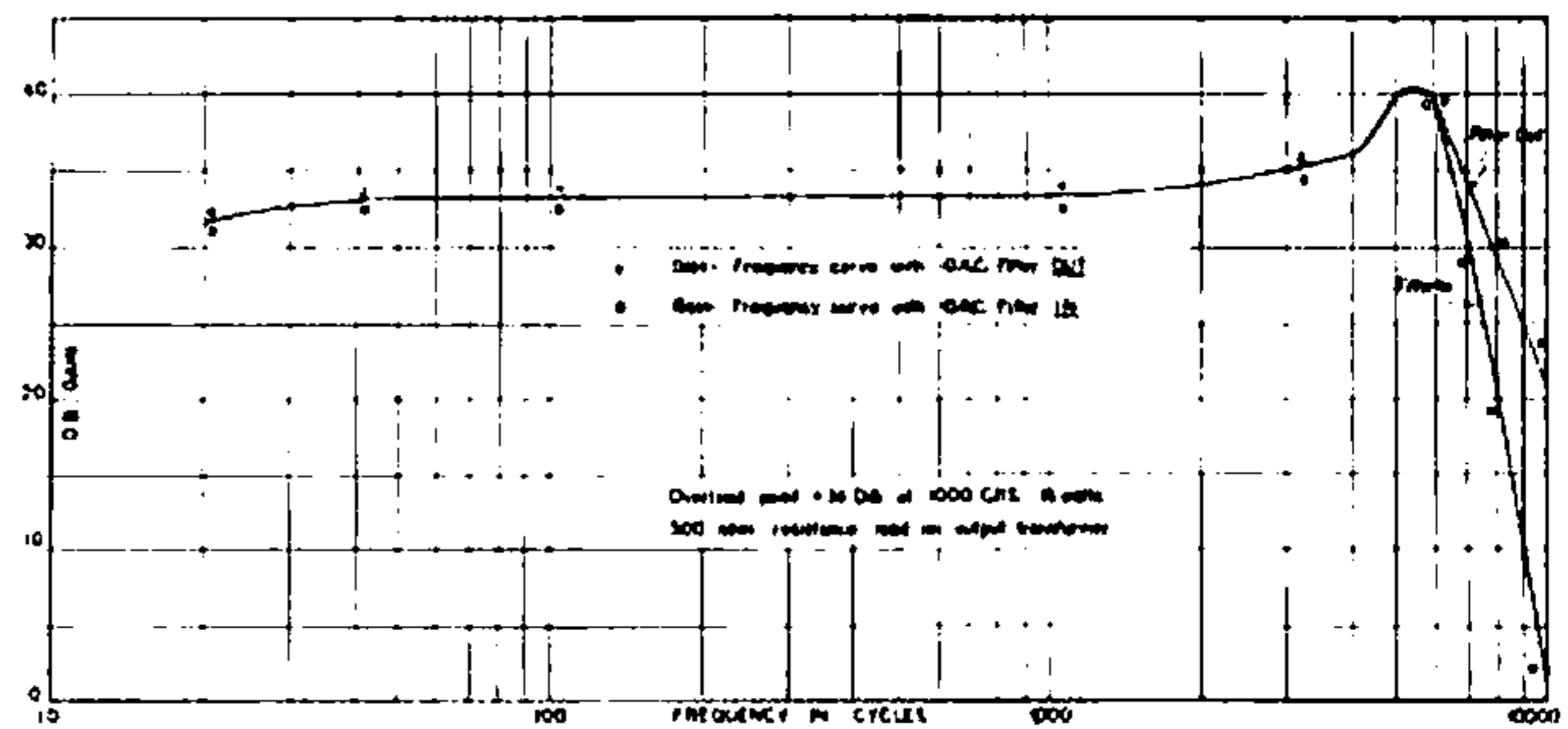
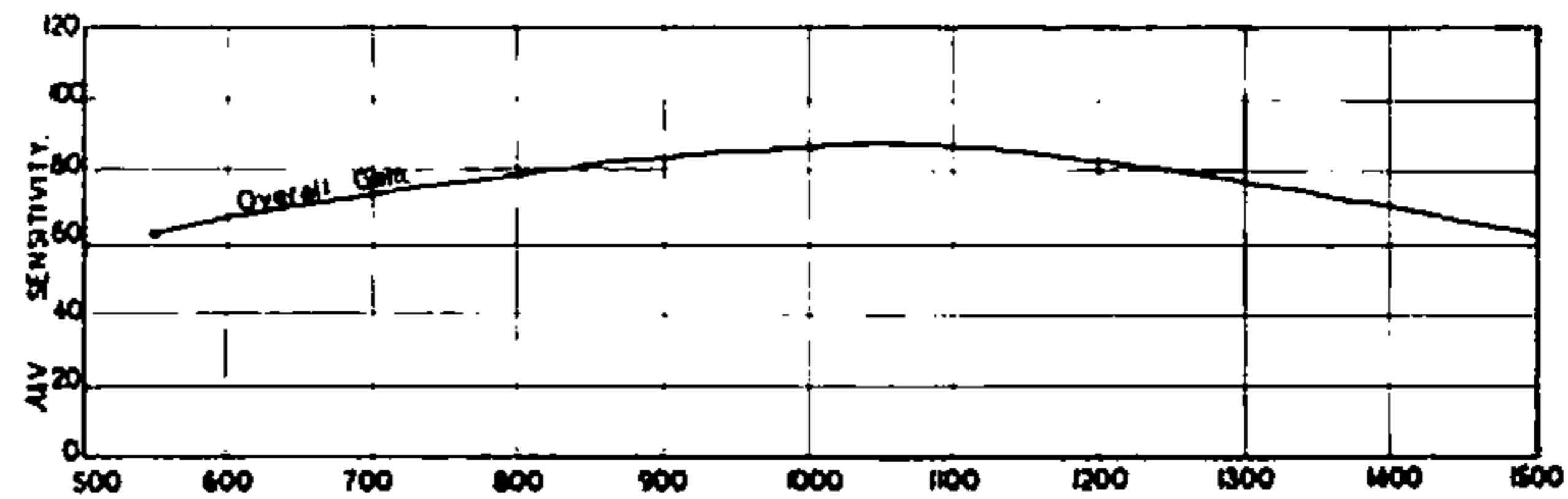
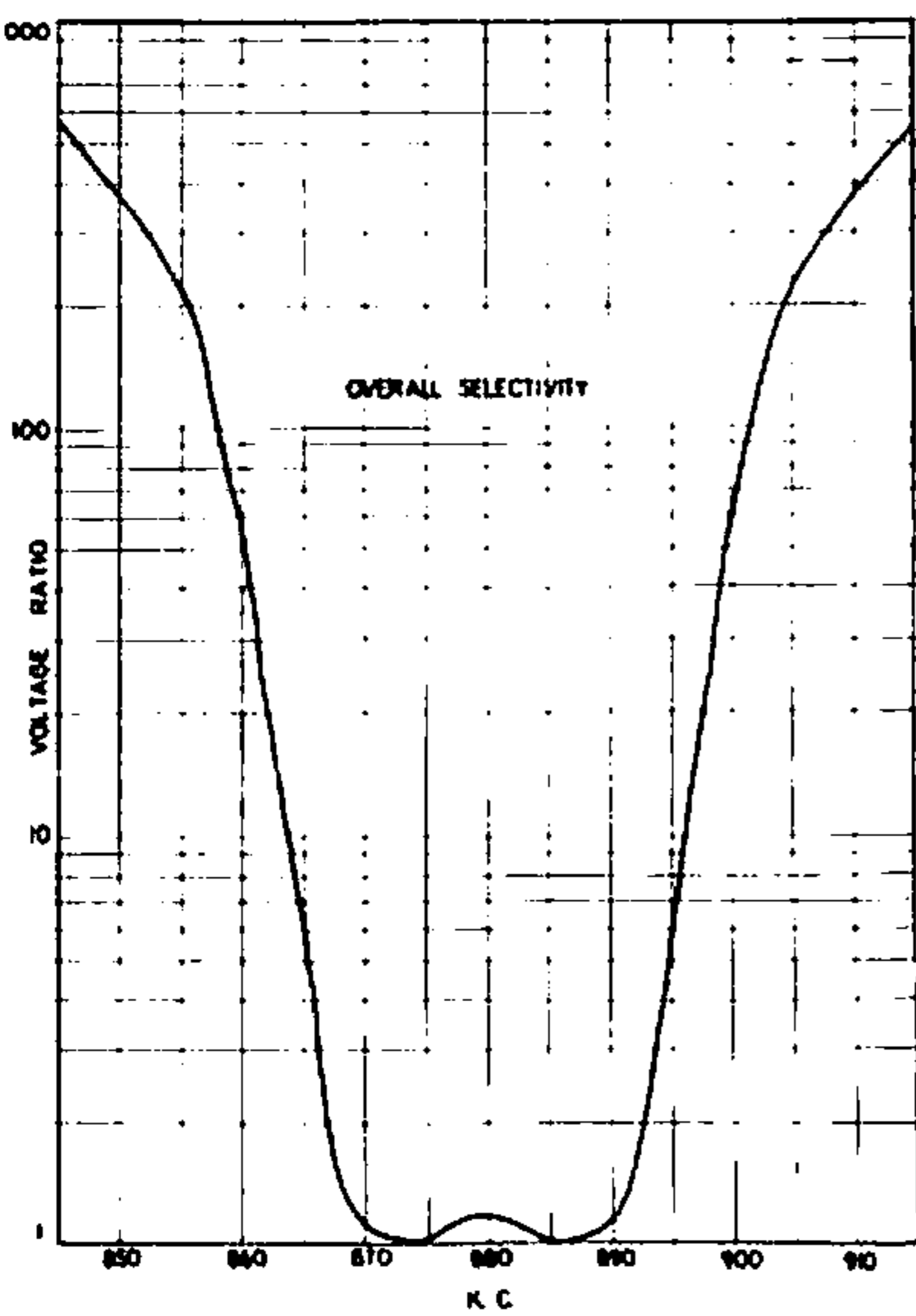
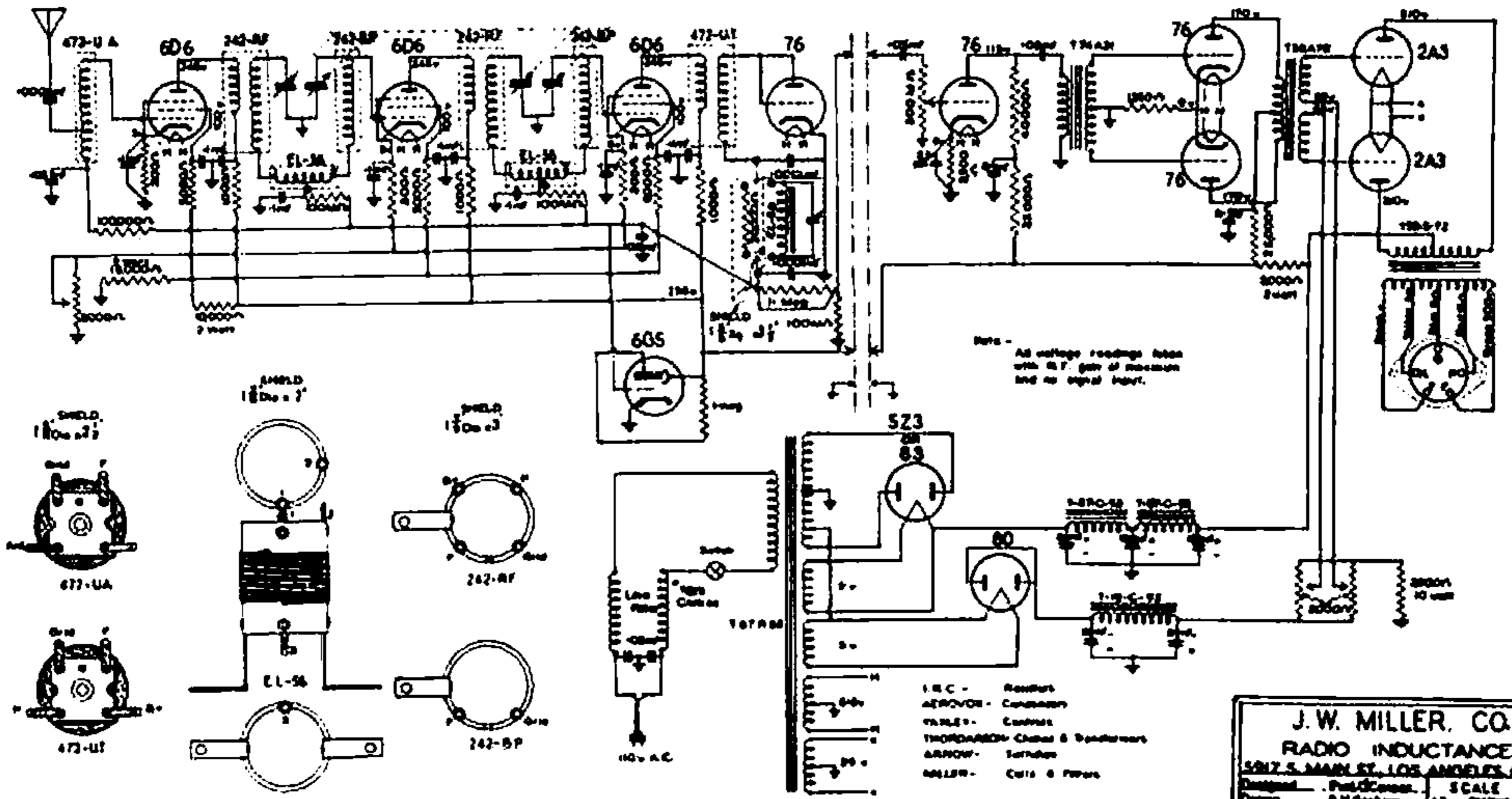

J. W. MILLER COMPANY

5917 South Main Street

Los Angeles, California



REPRESENTED BY

ROYE SALES AGENCY

11 Warren Street

NEW YORK, NEW YORK

Cortlandt 7-1148

HIGH FIDELITY TUNER.

INFINITE IMPEDANCE DETECTOR.

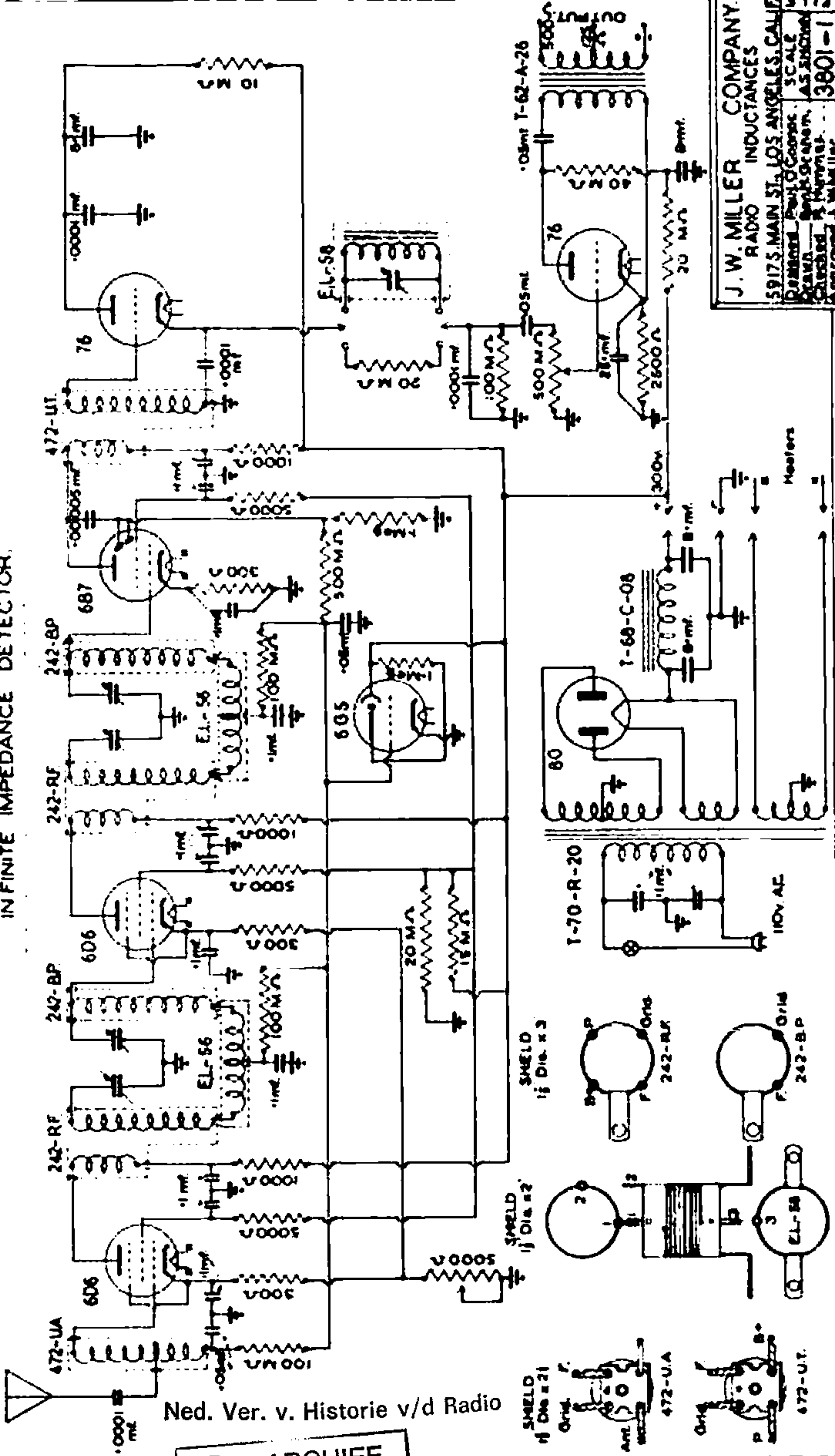

Ned. Ver. v. Historie v/d Radio



J. W. MILLER COMPANY.
 RADIO INDUCTIONS
 5917 S. MAIN ST., LOS ANGELES, CALIF.
 Distributors: Paul O. Coors, S. C. Ale
 Ocean, S. G. Ostrom, A. S. Erickson
 Checked by: J. W. Miller
 J. W. Miller