

OC 44

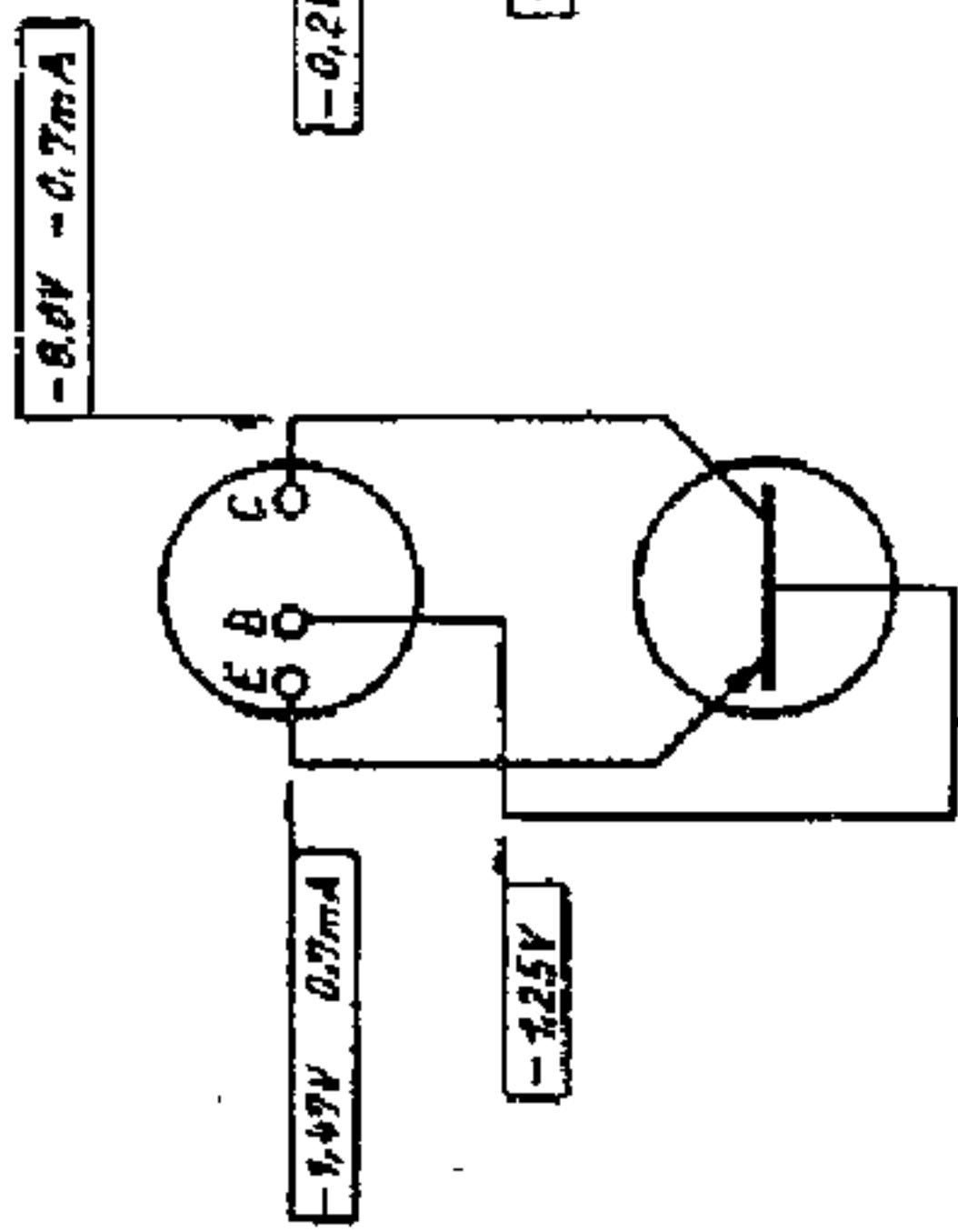

OC 45

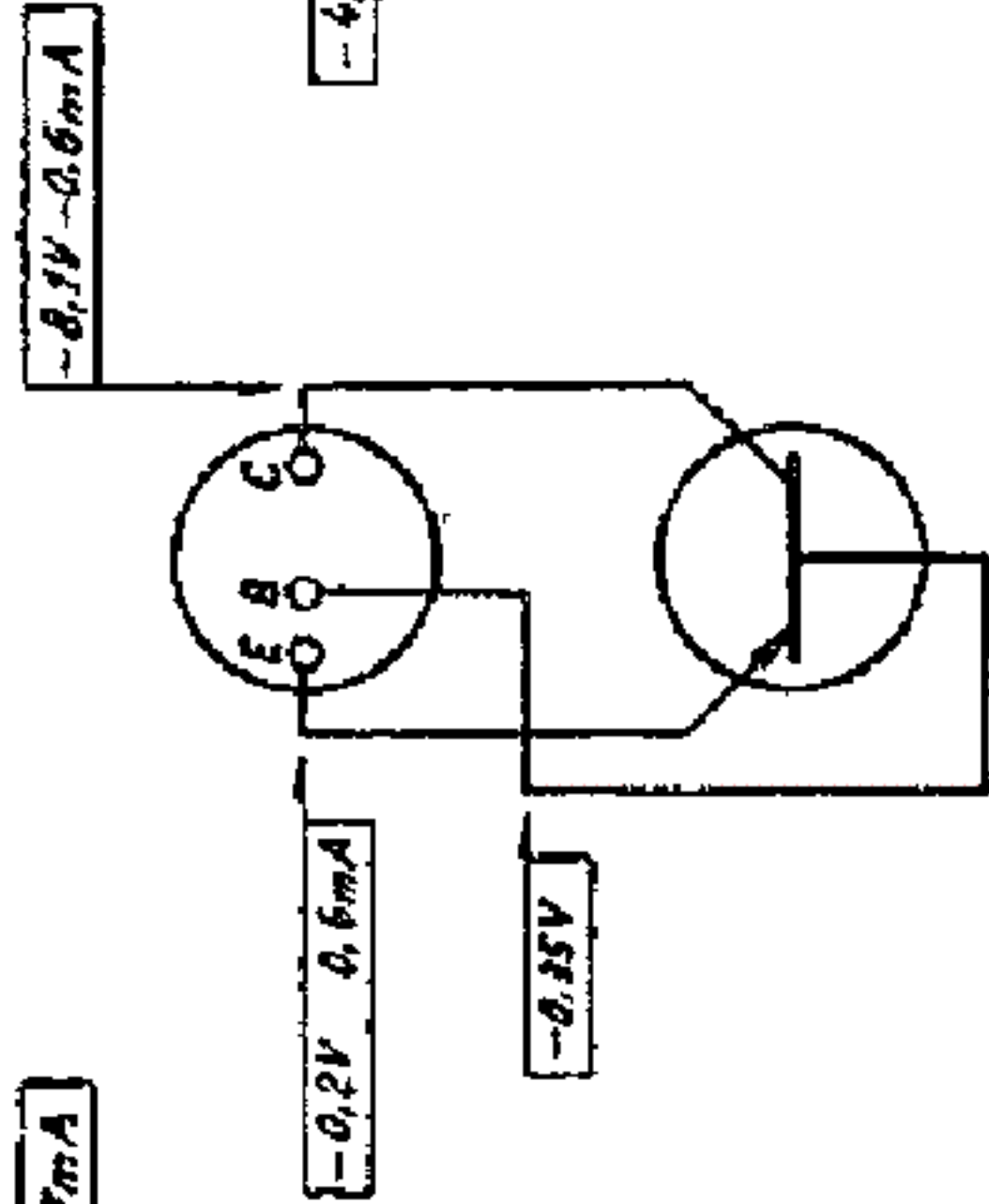

OC 71

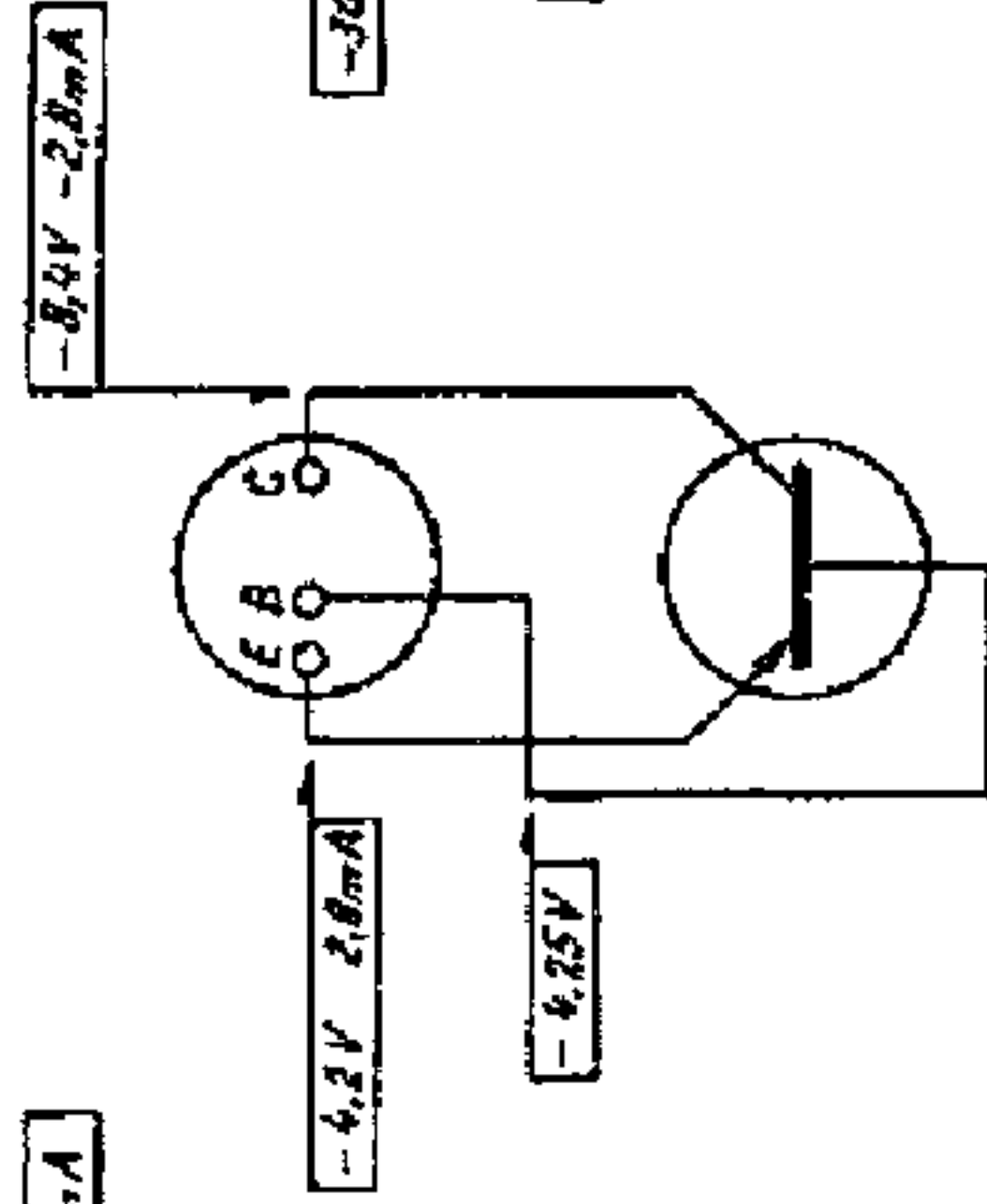

OC 72

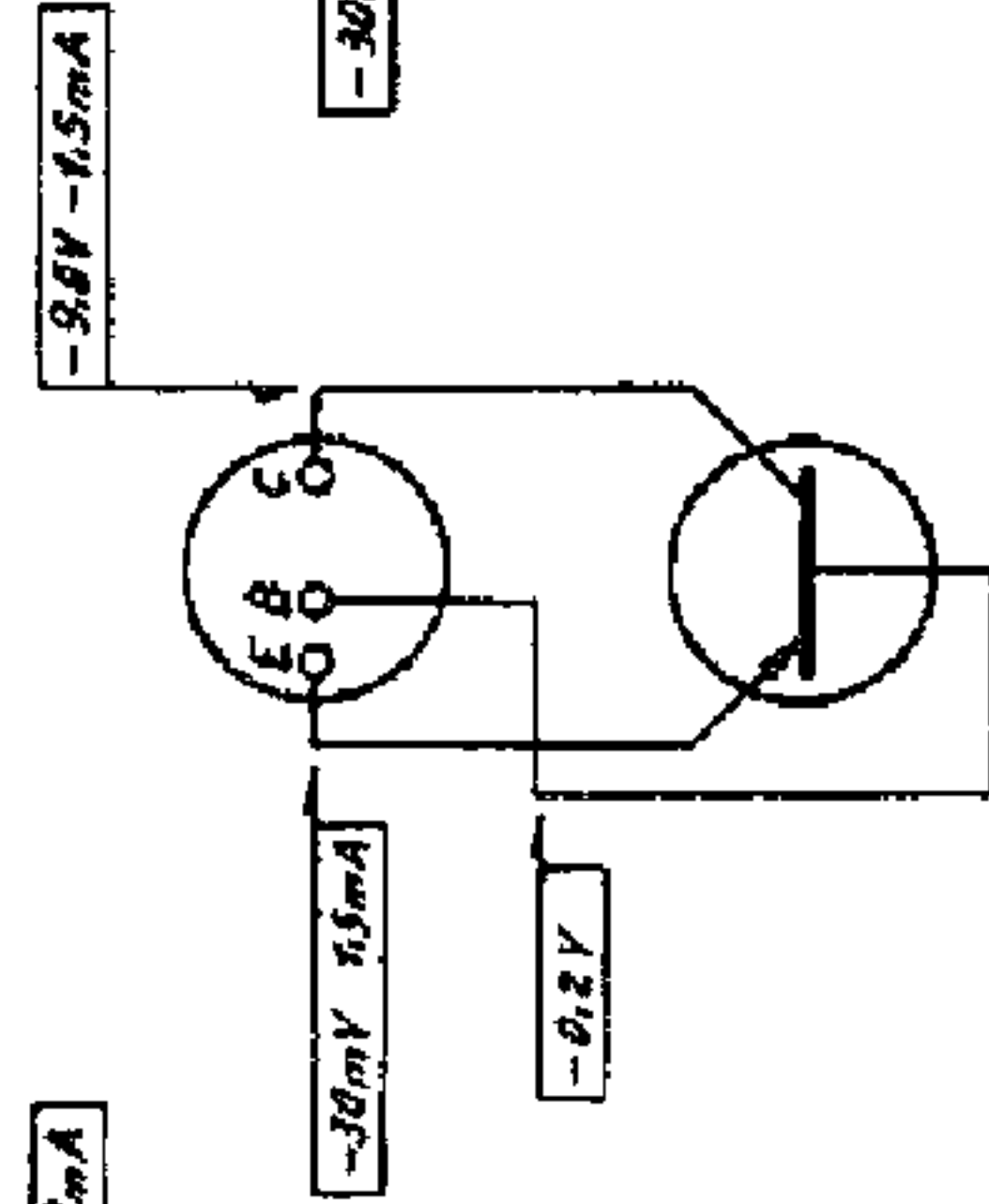

OC 72

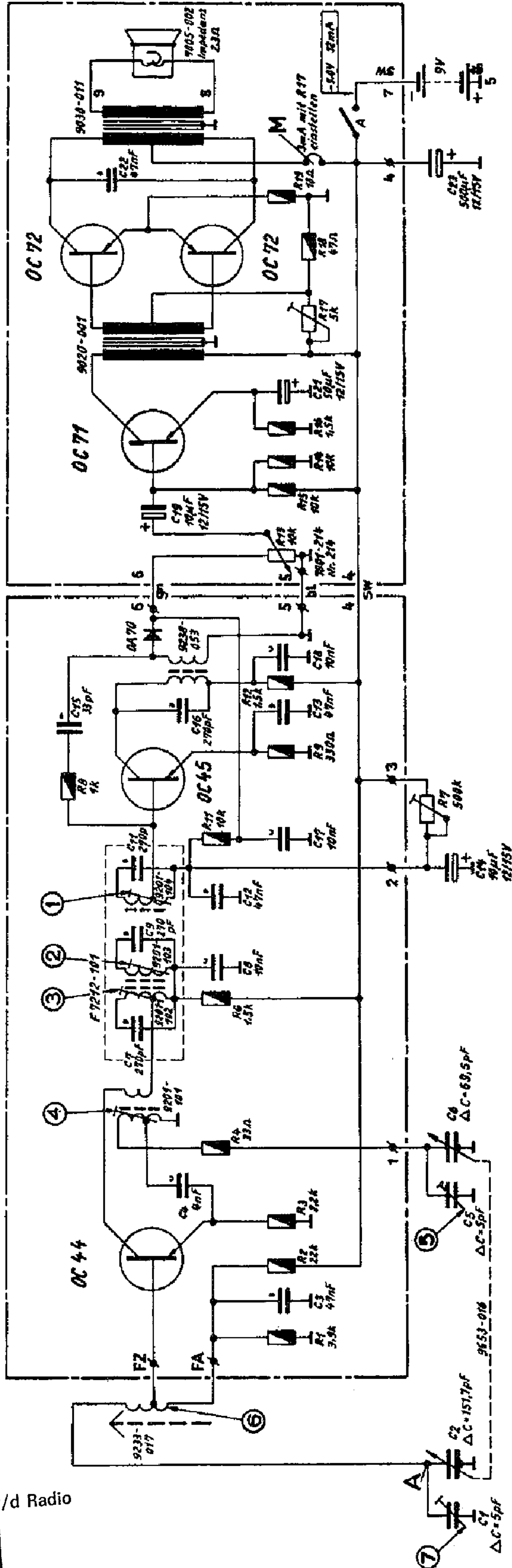
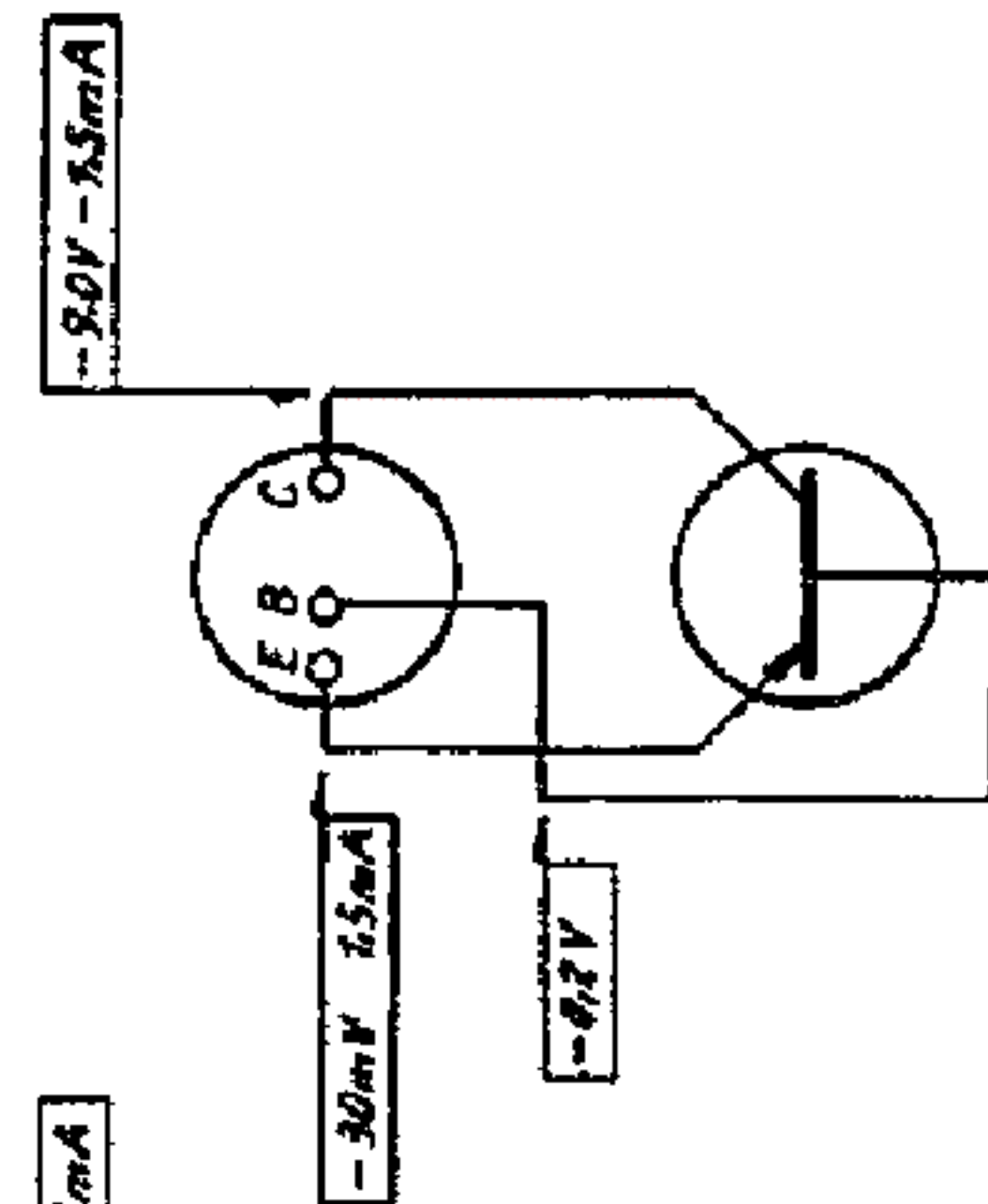

G Nr c 798

24258 He

C:	1.	2.	3.	4.	5.	6.	7.	8.	9.	10.	11.	12.	13.	14.	15.	16.	17.	18.	19.	20.	21.	22.	23.	24.
R:	1.	2.	3.	4.	5.	6.	7.	8.	9.	10.	11.	12.	13.	14.	15.	16.	17.	18.	19.	20.	21.	22.	23.	24.

125V - Kerstfolie



150V - Papier

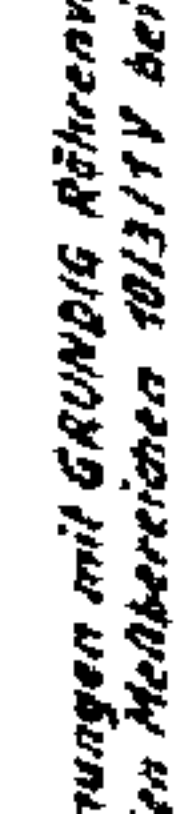

Spannungen mit GRUNDIG Röhrenvoltmeter auf den Meßbereichen 10/1/1V bei 9V-Batteriespannung gemessen. Spannungs- und Stromwerte gültig bei eingedrehtem Drehkä ohne Signal

Wellenbereich: MW 570... 1620kHz

AM-Spulenart Nr. 7213-501
ZF = 460kHz

GRUNDIG WERKE FURTH (BAY.)

„Transistor-Box“

Änderungen vorbehalten

(1082-001)