

Spannungen bei:  
ALL VOLTAGES MEASURED

Aufnahme  
IN RECORD POS.  
Wiedergabe  
IN PLAYBACK POS.

ohne Signal mit GRUNDIG RVH Typ 6052  
(R = 30 MΩ) gegen Chassis gemessen.  
WITHOUT SIGNAL WITH GRUNDIG RVH TYPE 6052 (15P)  
TO CHASSIS (INPUT RESISTANCE = 30MΩ)

(L) Lautstärke / Pegelregler Mikro-Radio  
VOLUME / LEVEL CONTROL MICRO-RADIO

(P) Pegelregler Platte  
GRAN. CONTROL

(K) Klang  
TONE / M

Ned. Ver. v. Historie v/d Radio

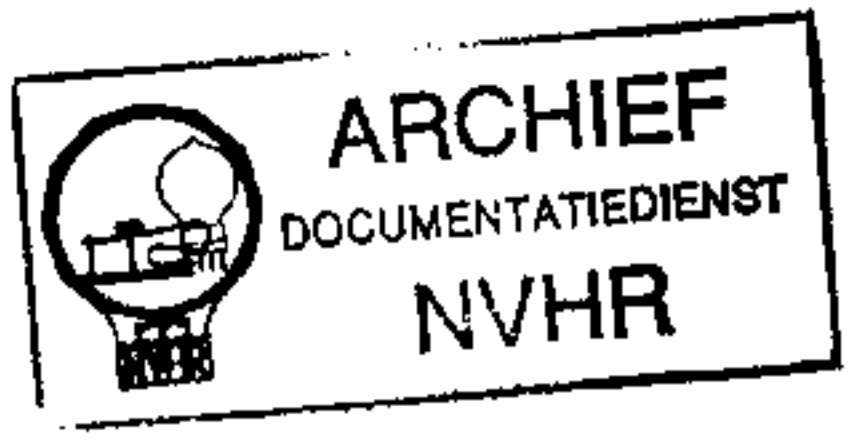

Zusatzverstärker  
2. Laufwerk  
AUXILIARY AMPLIFIER  
2. SPEAKER

Filmanschluß

Mikro  
MICRO

Telefonadapter

Radio  
RADIO (DIODE)

Platte  
GRAN.

Fernbedienung  
REMOTE CONTROL

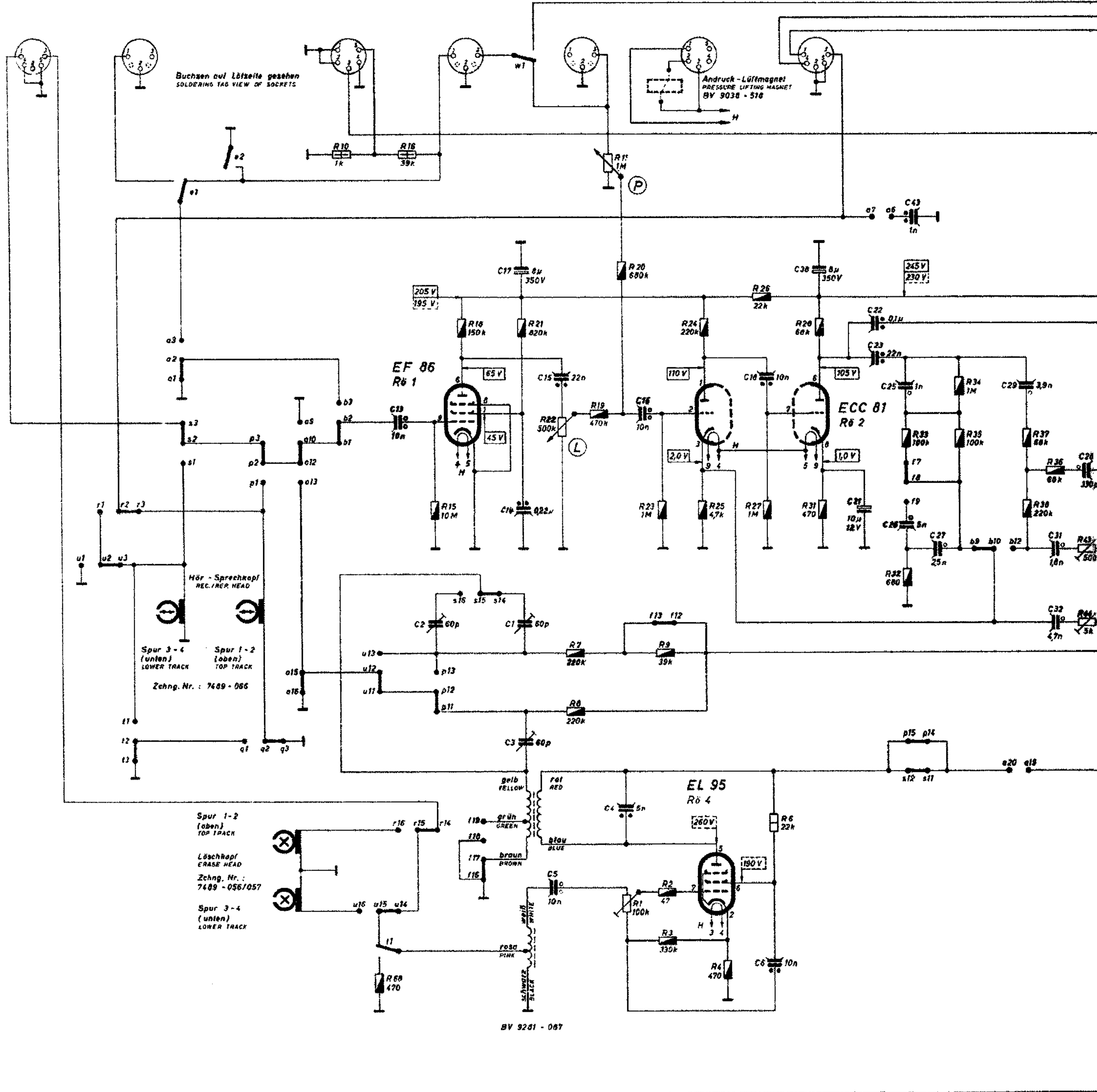

R		10	60	18	15	18	21	22	7,8	19,11,20,1	28,9,4,3	25	24	4	26,27,E	28,31	33,32	34,35	37,38	36	43,44
G				13	2		17,14,1,3	5,15		6	16				18,6	30	21,22,23	25,26,43,27	29	31,32	28

Aufnahmekontakte (gezeichnet in Stellung Wiedergabe)  
RECORDING BUTTONS (SHOWN IN POS. PLAYBACK)  
Auf die Kontakte gesehen  
CONTACT VIEW OF SWITCHES

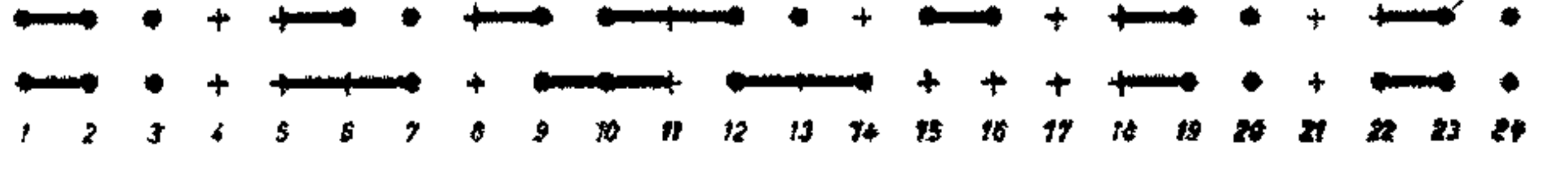

Wiedergabe → Aufnahme  
PLAYBACK → RECORDING

Geschwindigkeitsumschalter (gezeichnet in Stellung „19 cm/s“)  
SPEED SWITCH (SHOWN IN POS. "15 IPS")

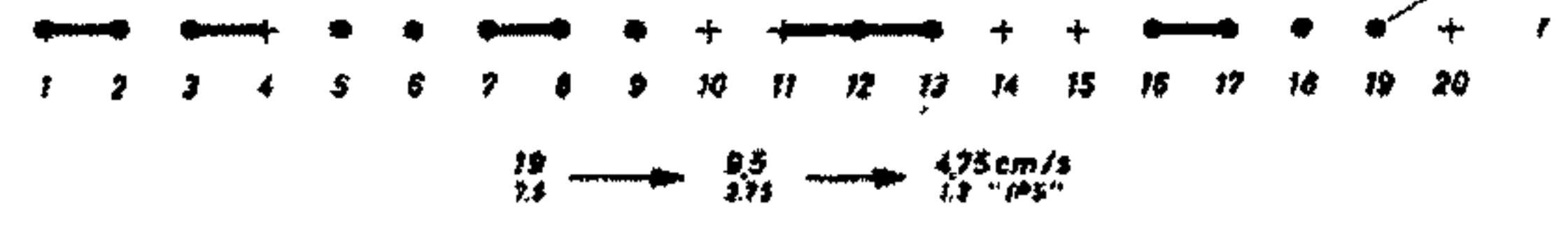

Nummern der Kontakte von der  
Beteiligungsseite aus gezählt.  
CONTACTS ARE COUNTED FROM  
OPERATING DEVICE.

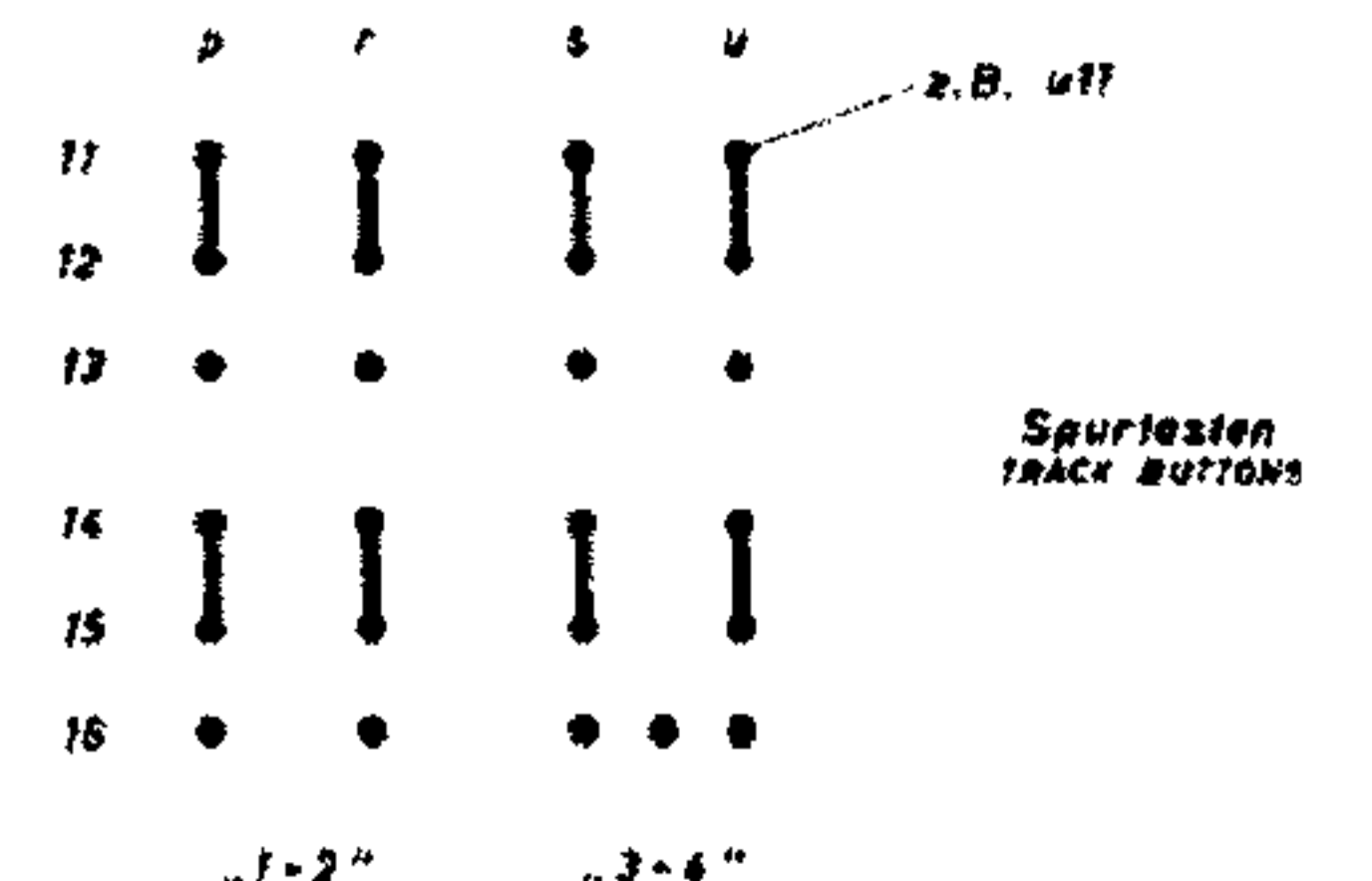

Auf die Kontakte gesehen  
CONTACT VIEW OF SWITCHES

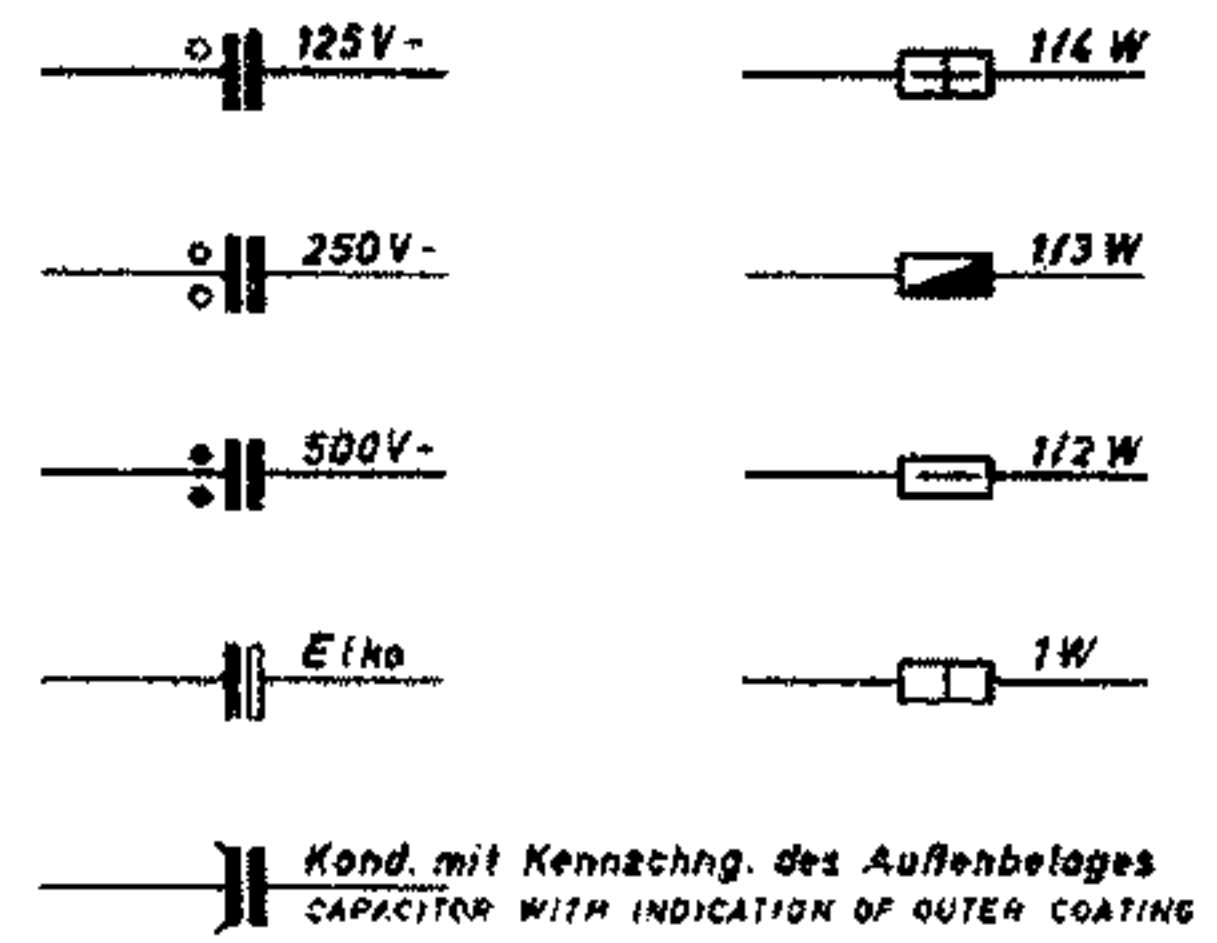
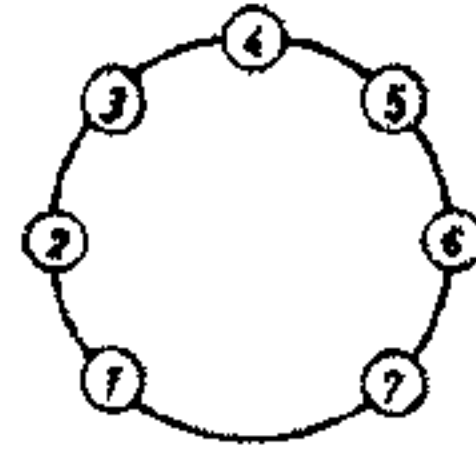
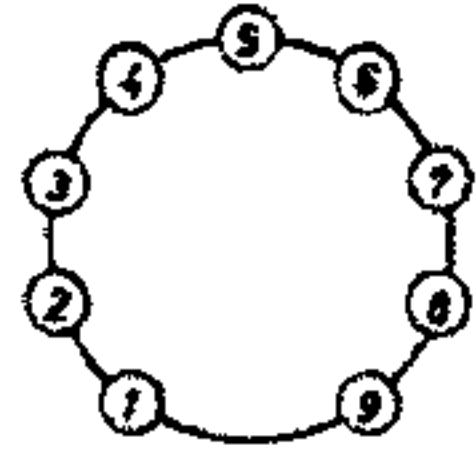

Motor	TK 40a	TK 40b
		7882-102
C 44	2 μF / 390 V ~ DB	8 μF / 125 V ~ DB
①	gelb YELLOW	gelb YELLOW
②	blau BLUE	rot RED
③	grün GREEN	grün GREEN

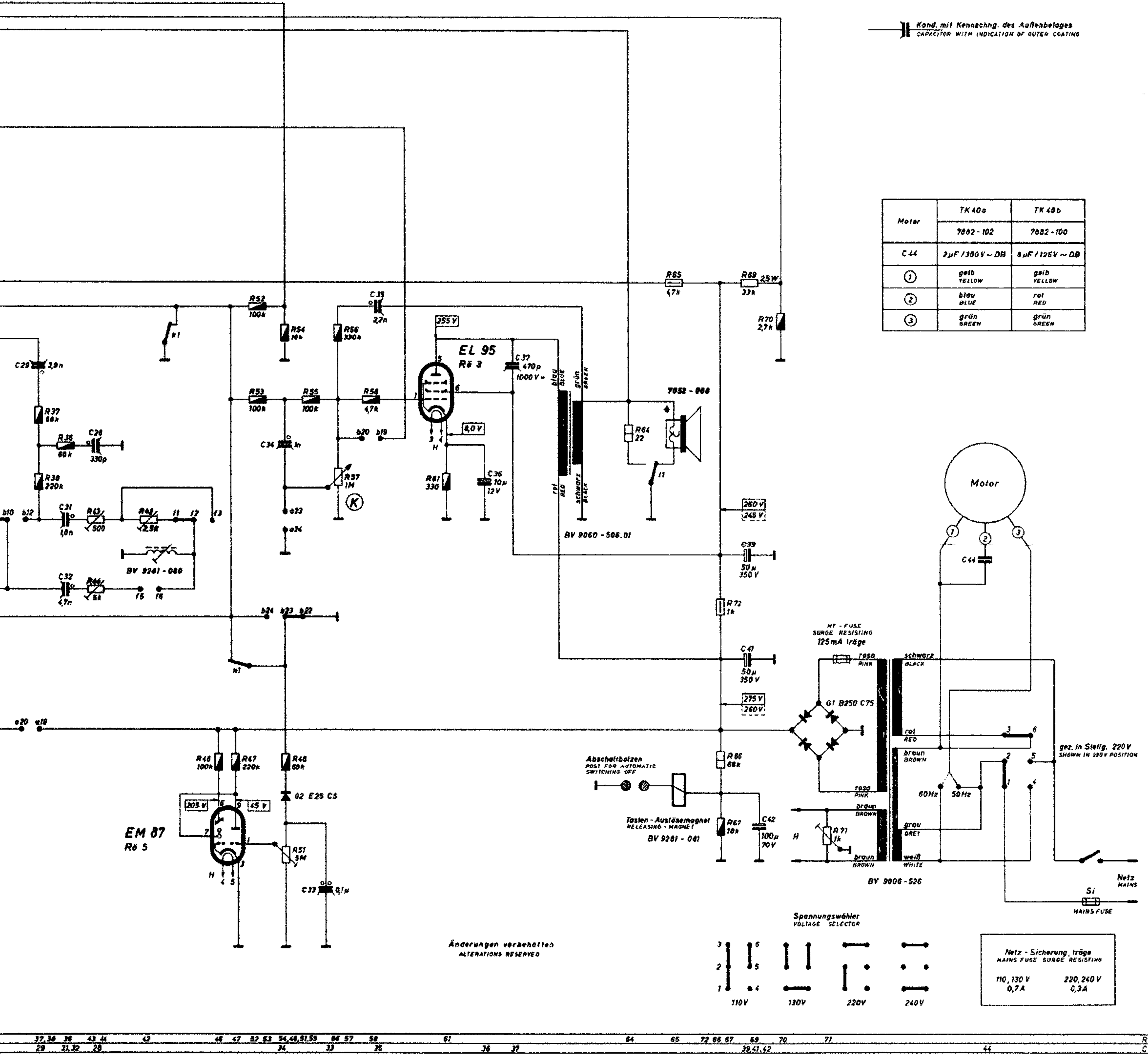

Änderungen vorbehalten  
ALTERATIONS RESERVED



Netz - Sicherung, träge  
MAINS FUSE SURGE RESISTING  
110, 130 V 0,7 A    220, 240 V 0,3 A

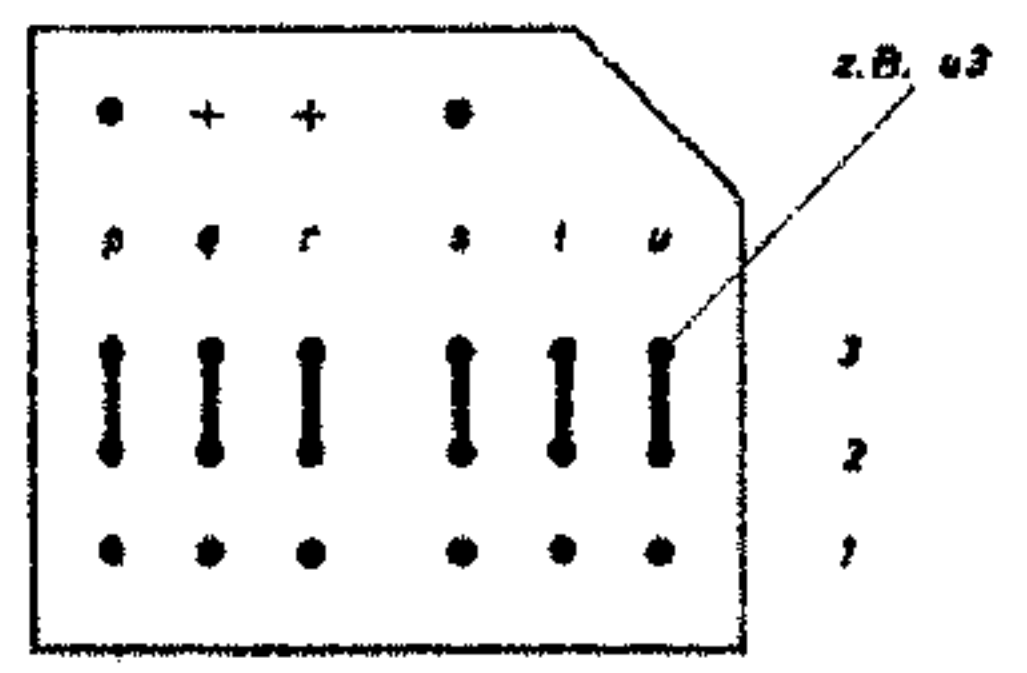

Kontaktfedersätze CONTACT SETS	Betriebsarten OPERATING POSITIONS						
	Halt STOP	Wiederg. PLAYBACK	Aufn. REC	Lauf WIND	Trick TRICK	Netz aus MAINS OFF	
Drucktastenagg. PUSH BUTTON UNIT	11						
Keptträger HEAD BASE ASSY.	w1						
Geschw.-Umseh. SPEED SWITCH	n1						
	n1						

Kontaktfedersätze in Ruhestellung gezeichnet  
CONTACT SETS IN NEUTRAL POSITION

**GRUNDIG WERKE FÜRTH (BAY.)**  
**TK 40**  
(39-5056-1000/S)

„1-2“ „3-4“

Auf Lötseite gezeichnet  
SOLDERING TAG VIEW

e12 = Eingangsumschalter Mikro - Radio,  
gezeichnet in Stellung Radio  
11 = Lautsprecher-Schalter

e12 = INPUT SWITCH MICRO - RADIO  
SHOWN IN POS. RADIO  
11 = SPEAKER SWITCH

Federsätze betätigt  
CONTACTS SETS OPERATED