

GRUNDIG TAPE RECORDERS Models TK30, TK35

General Description: Dual-track, portable tape recorders with maximum spool diameter of 7 in. Model TK30 has two speeds ($7\frac{1}{2}$ and $3\frac{3}{4}$ in./sec.). Model TK35 has the additional speed of $1\frac{7}{8}$ in./sec.

Power Supply: A.C. mains, 110-120, 140-175 and 200-250 volts. Mains current 500 mA. on 200-250 volts.

Valves: (V₁) EF86; (V₂) ECC81; (V₃) EL84; (V₄) EL95; (V₅) EM84.

Notes: Drive is obtained from flywheel driven by outer rotating cage split-phase induction motor. Tape is friction driven between capstan spindle on flywheel and rubber pressure roller, controlled by pressure solenoid. Speed change obtained by moving endless plastic drive belt from one pulley to another on motor spindle: on TK35 speed change from $3\frac{3}{4}$ to $1\frac{7}{8}$ in./sec. carried out electrically. Spools are carried on top halves of friction clutches, clutching being proportional to weight of tape and spool. Digital type position indicator. Metal foils, as fitted to Grundig tapes, cause motor to be switched off at end of tape. Second H.T. supply used to energise relays and pressure solenoid. L.T.1 supply for V₁ is fitted with humdinger. Microphone socket is polarised with 100 volts D.C.

H.F. oscillator frequency about 78 kc/s. R₃ controls amplitude and C₂ controls level of bias fed to head on the TK30.

Relay Operation: *Switch on.* R.I. energises via E, I and K. R.I.1 closes and holds R.I. R.I.2 closes and starts motor. *To Record. Press Record Button.* N opens to remove muting of ECC81. M closes to energise R.II via B. R.II.1 closes, short-circuits R₄₉ (on TK35, R.II.1 is change-over contact). R.II.2 changes over, reducing the holding current through relay R.II. R.II.3 opens, removes muting of ECC81. R.II.4 changes over, selects recording characteristics. R.II.5 closes, connects H.T. to EM84. R.II.6 changes over, couples radio L.S./Gram. P.U. input. R.II.7 changes over, switches in record level control, R₁₆. R.II.8 opens, removes short circuit on recording amplifier output. R.II.9 changes over, removes short-circuit on input and earths one side of record/playback head. R.II.10 changes over, connects input to V₁. *Press Start Key.* D closes, holds R.II. B opens, disconnects initial energising path to R.II. C changes over, connects radio L.S./Gram. P.U. to "diode" output on pin 3. E opens, removes initial energising path to R.I. F closes, feeds H.T. to oscillator. G opens, removes playback muting of ECC81. H closes, energises R.III via S and remote control socket, also energises pressure solenoid via R.I.1, J, L, S, H and shorting contacts in remote control socket. R.III energises, removing brakes. R.III.1 changes over, limits current through R.III. Tape begins to move. *Press Temporary Stop.* S opens. Pressure solenoid, L₂, de-energises. R.III falls off and applies brakes. *Press Stop Key.* Other buttons returned to "neutral" by mechanical linkage. A holds R.I energised. D opens and de-energises R.II. H opens

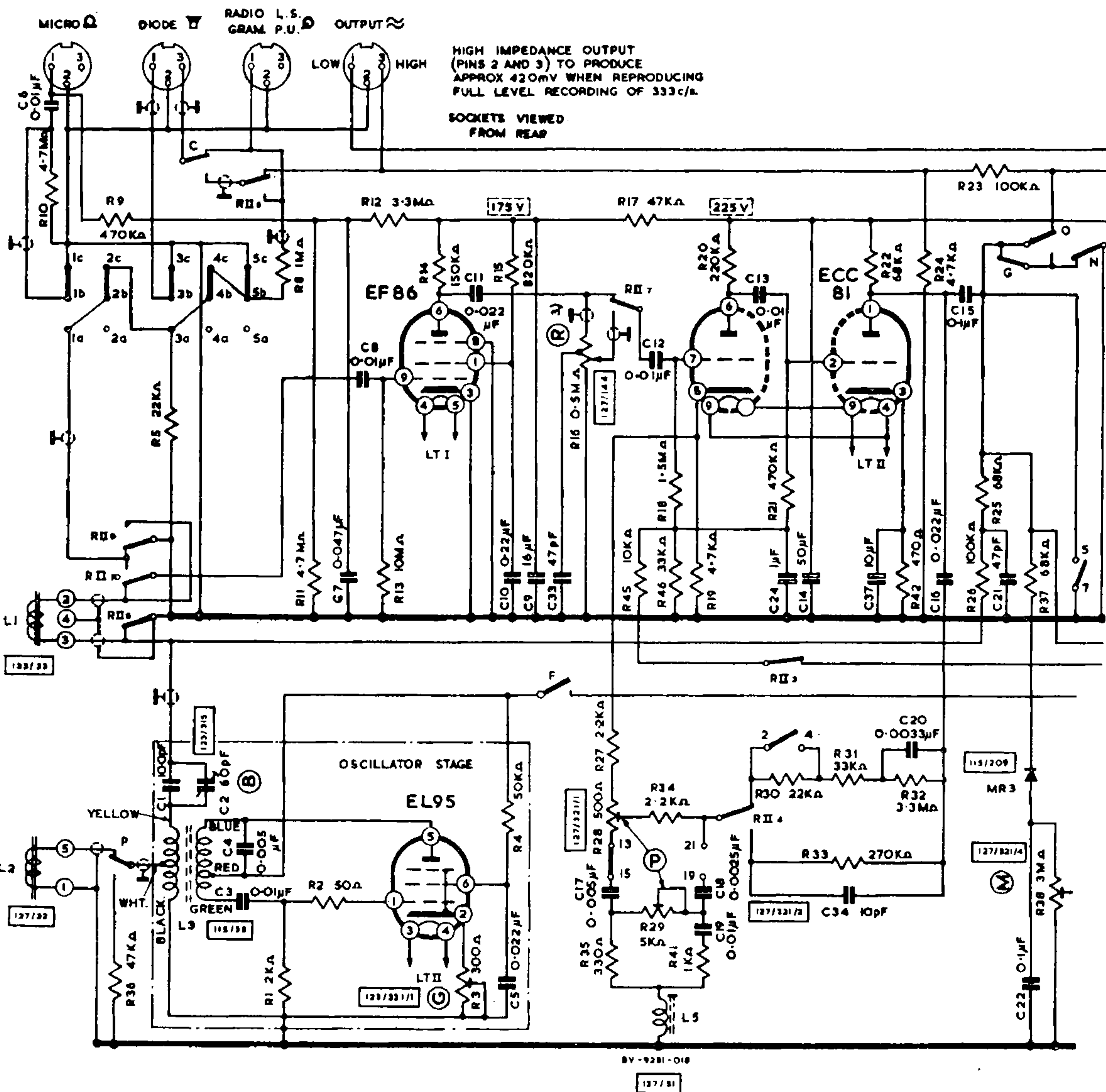

CIRCUIT DIAGRAM—

and de-energises R.III and pressure solenoid. *Later models:* E closes, holding R.I via 1k; A opens when stop button released.

To Playback. Press Start Key: B opens, removes muting from ECC81. C changes over, connects high-impedance output to diode socket. D closes, no effect. E opens, no effect. F closes, no effect. G opens, removes muting on ECC81 output. H closes, energises pressure solenoid and R.III (to remove brakes). The tape begins to move. R.II.9 short-circuits inputs. R.II.8 short-circuits recording amplifier output and earths recording/playback head. R.II.10 couples recording/playback head

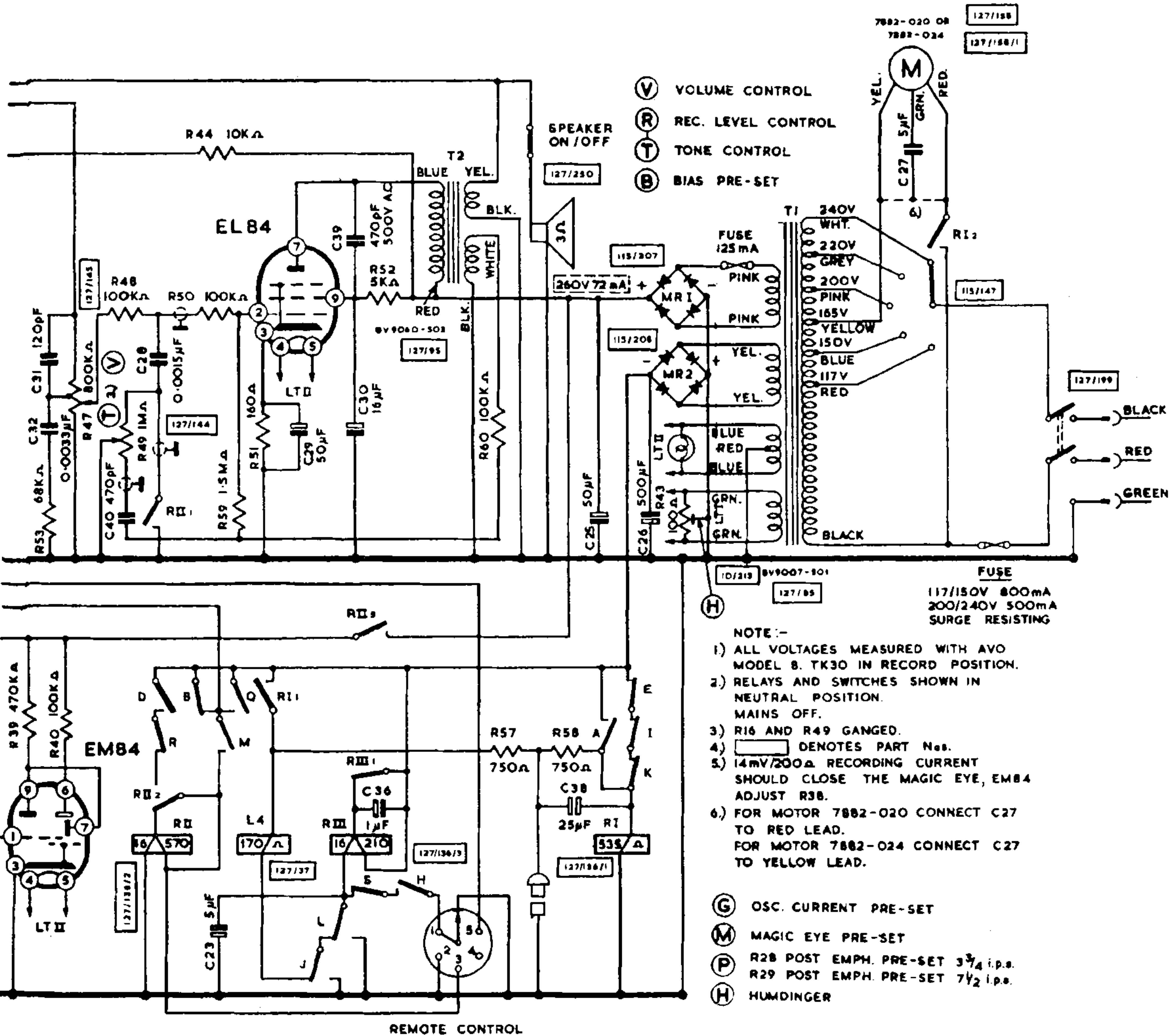
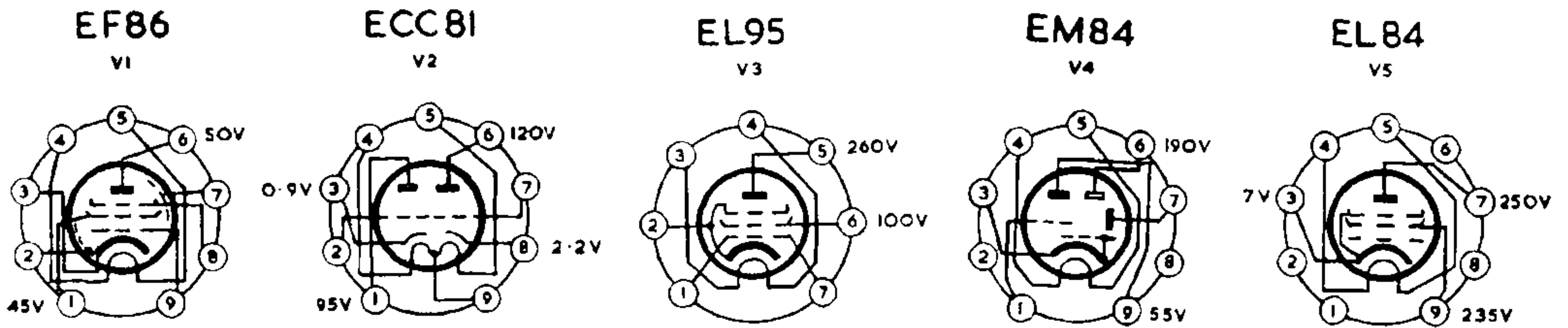

GRUNDIG MODEL TK30. (Before serial number 5025)

to grid of V_I. R.II.7 by-passes recording level control. R.II.1 removes short-circuit from tone control. R.II.4 selects playback characteristic. R.II.5 disconnects H.T. from oscillator and EM84.

To Superimpose. Turn and depress recording button and hold down. P disconnects erase head, and O disconnects high-impedance output and output stage. R opens and isolates R.II. Q closes to complete alternative path to R.II via M. Remainder of procedure is as for recording.

Fast Rewind. J changes over. R.III is energised via J to chassis. Pressure solenoid is de-energised.

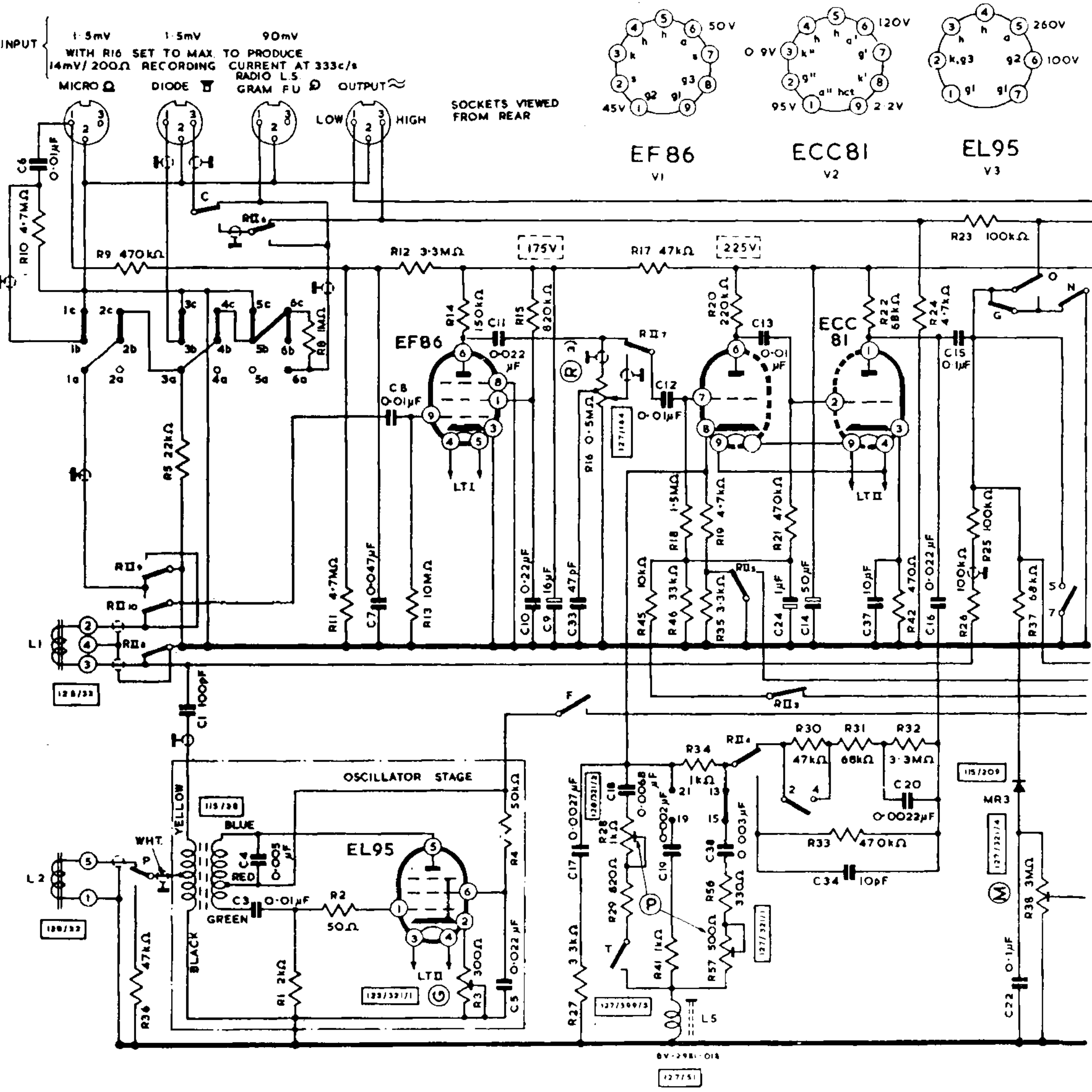

CIRCUIT DIAGRAM—

Fast Forward. L changes over, then as above.

Chassis Removal: Pull off speed-change knob; undo four brass coin-clotted screws securing top deck. Lift off top deck with Stop/Start and Fast Wind keys held down. Undo four small nuts holding chassis in cabinet (use 3 B.A. box spanner). Pull out loudspeaker plug, and lift chassis out of cabinet. When lifting chassis, on no account lift by clutches, or serious damage may result.

All drive belts other than motor pulley/flywheel are readily accessible with top deck removed. Majority of components may be reached, but if necessary chassis may be separated by undoing three screws on top of main

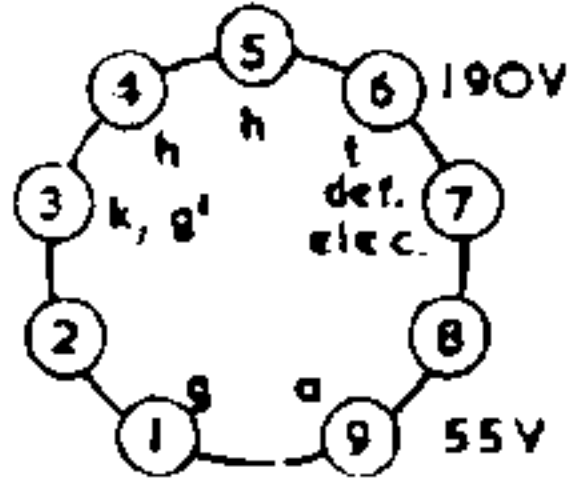

EM84
V4

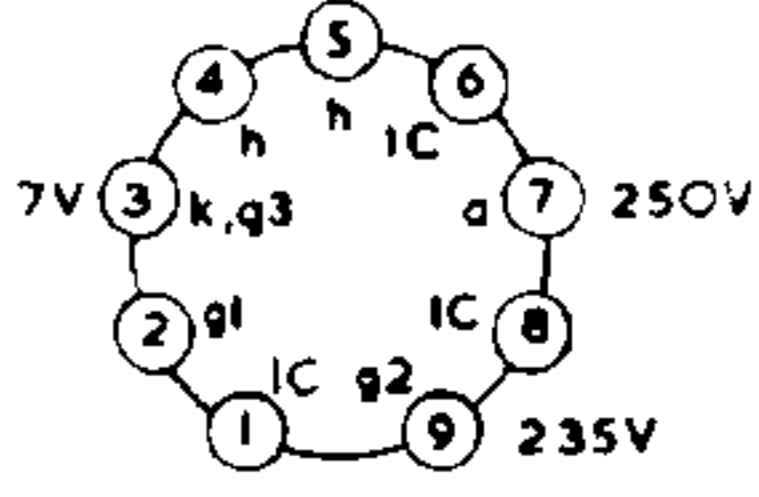

EL84
V5

- (V) VOLUME CONTROL
- (R) REC LEVEL CONTROL
- (T) TONE CONTROL
- (G) OSC CURRENT PRE-SET
- (M) MAGIC EYE PRE-SET
- (P) R57 POST EMPH. PRE-SET $3\frac{3}{4}$ i.p.s
- (P) R28 POST EMPH. PRE-SET $1\frac{7}{8}$ i.p.s.
- (H) HUMDINGER

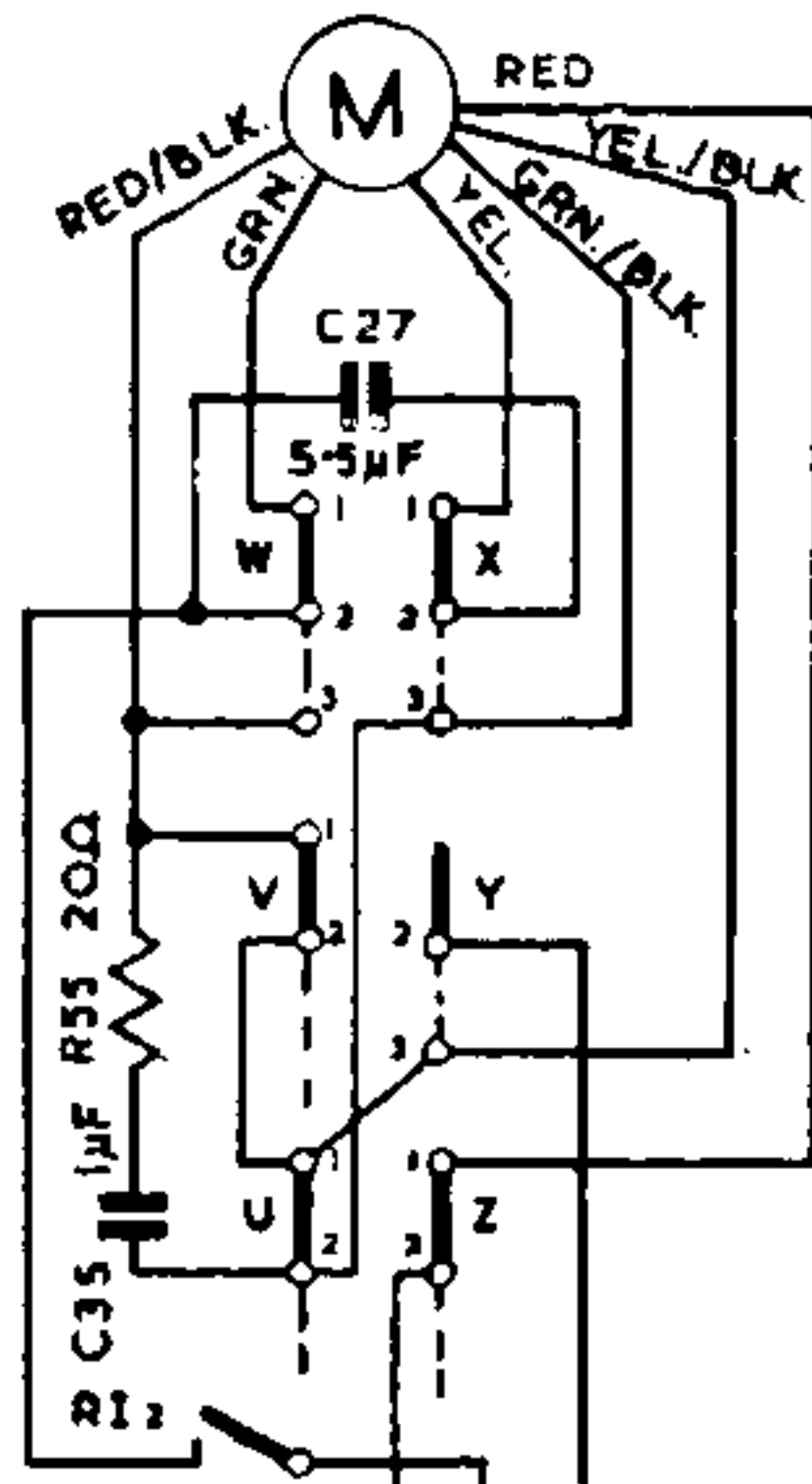

7 1/2 ins./sec
3 3/4 ins./sec
1 7/8 ins./sec
128/301

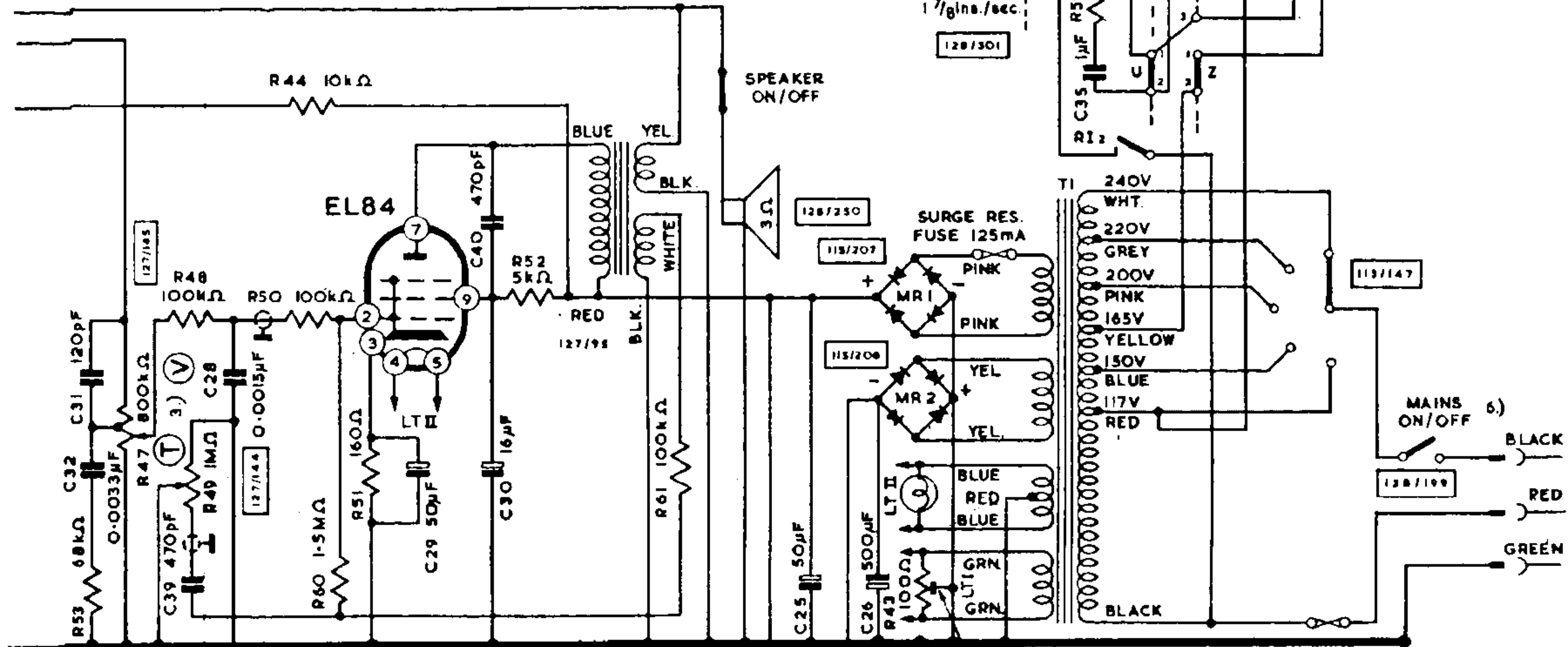

FUSE
117/150V 800mA
200/240V 500mA
SURGE RESISTING

- NOTE**
- 1) ALL VOLTAGES MEASURED WITH AVO MODEL B. TK35 IN RECORD POSITION.
 - 2) RELAYS AND SWITCHES SHOWN IN NEUTRAL POSITION. MAINS OFF.
 - 3) R16 AND R49 GANGED.
 - 4) [] DENOTES PART Nos.
 - 5) 14m/V 200Ω RECORDING CURRENT SHOULD CLOSE MAGIC EYE. EM84 ADJUST R38.
 - 6) MICRO SWITCH OPERATED BY SPEED CHANGE SWITCH.

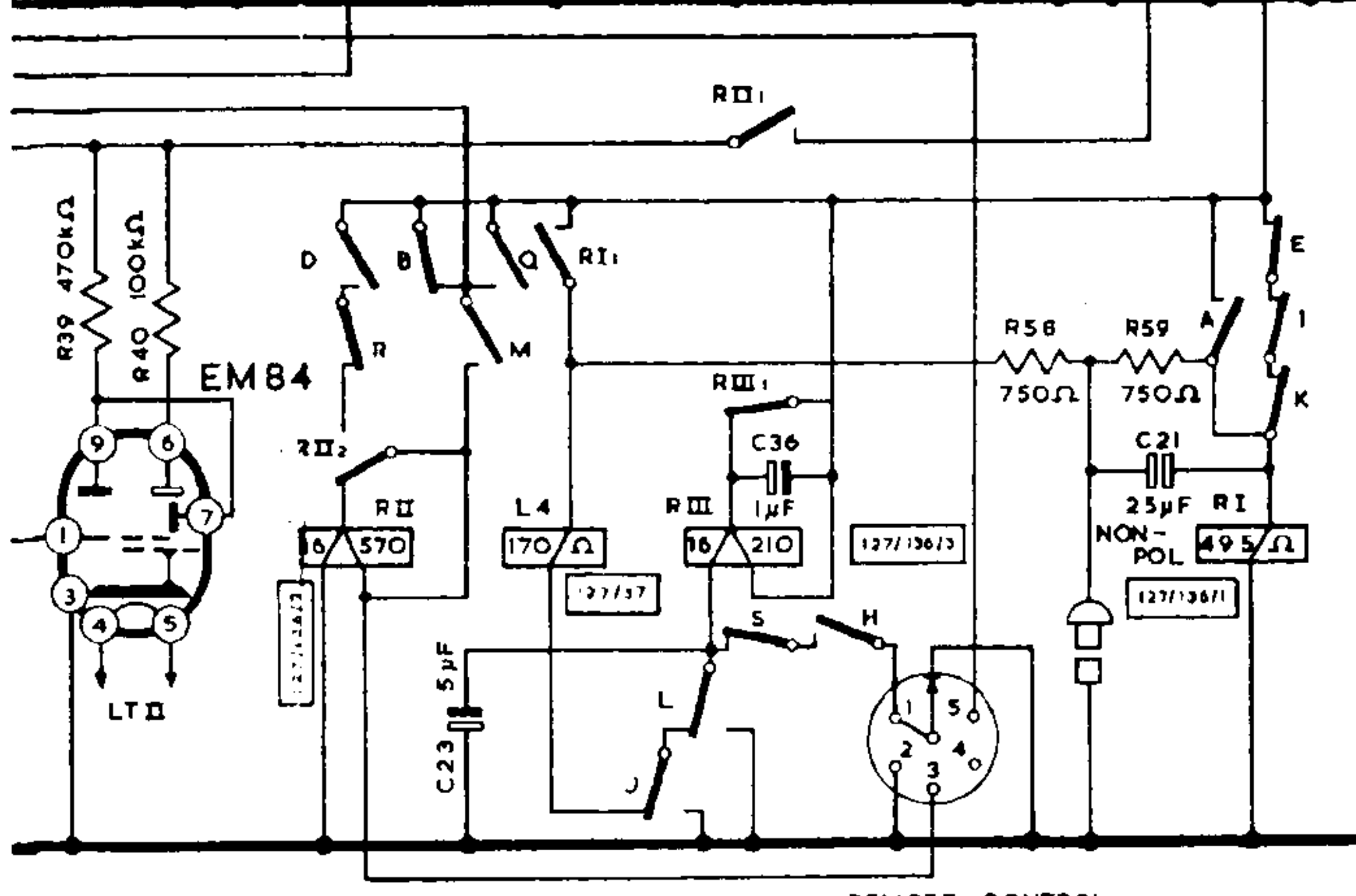

REMOTE CONTROL

GRUNDIG MODEL TK35. (Before serial number 5027)

chassis (two at back, one on right-hand side) and three screws holding brackets to front and left-hand side of sub-chassis. To obtain complete separation retaining screws for selector buttons, control keys, record/super-impose button, pilot bulb, mains switch and pressure solenoid must be removed, in addition to unsoldering head lead from tag strip at back of sound channel and leads to right-hand tape guide. With TK35, mains switch may be left in position if leads are unsoldered to both this and speed-change button; alternatively whole speed-change switch and selector assembly may be dismantled.

Clutches: Clutches are of friction type and will not normally need

MICRO DIODE RADIO

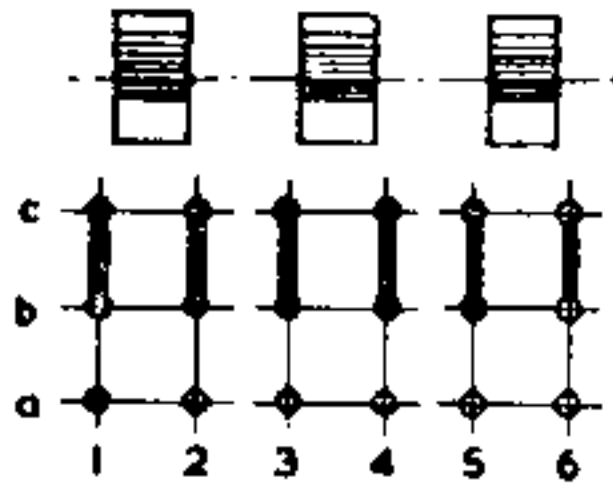

INPUT SELECTOR
VIEWED FROM REAR

127/329

INPUT { 1.5mV 1.5mV 90mV
WITH R16 SET TO MAX. TO PRODUCE
14mV/200Ω RECORDING CURRENT AT 333c/s

CONTACT SPRING SETS

	PART No.					
STOP	127/399/1	A				
START	127/399/2	B	D	F	H	
	127/399/3		C	E	G	
FAST WIND ←	127/399/4	I	J			
FAST WIND →	127/399/4	K	L			
RECORDING	127/399/6	M	N			
ERASE CUT OUT	127/399/7	O	P	Q	R	
TEMP. STOP	127/399/8	S				

HEAD METERING NETWORK

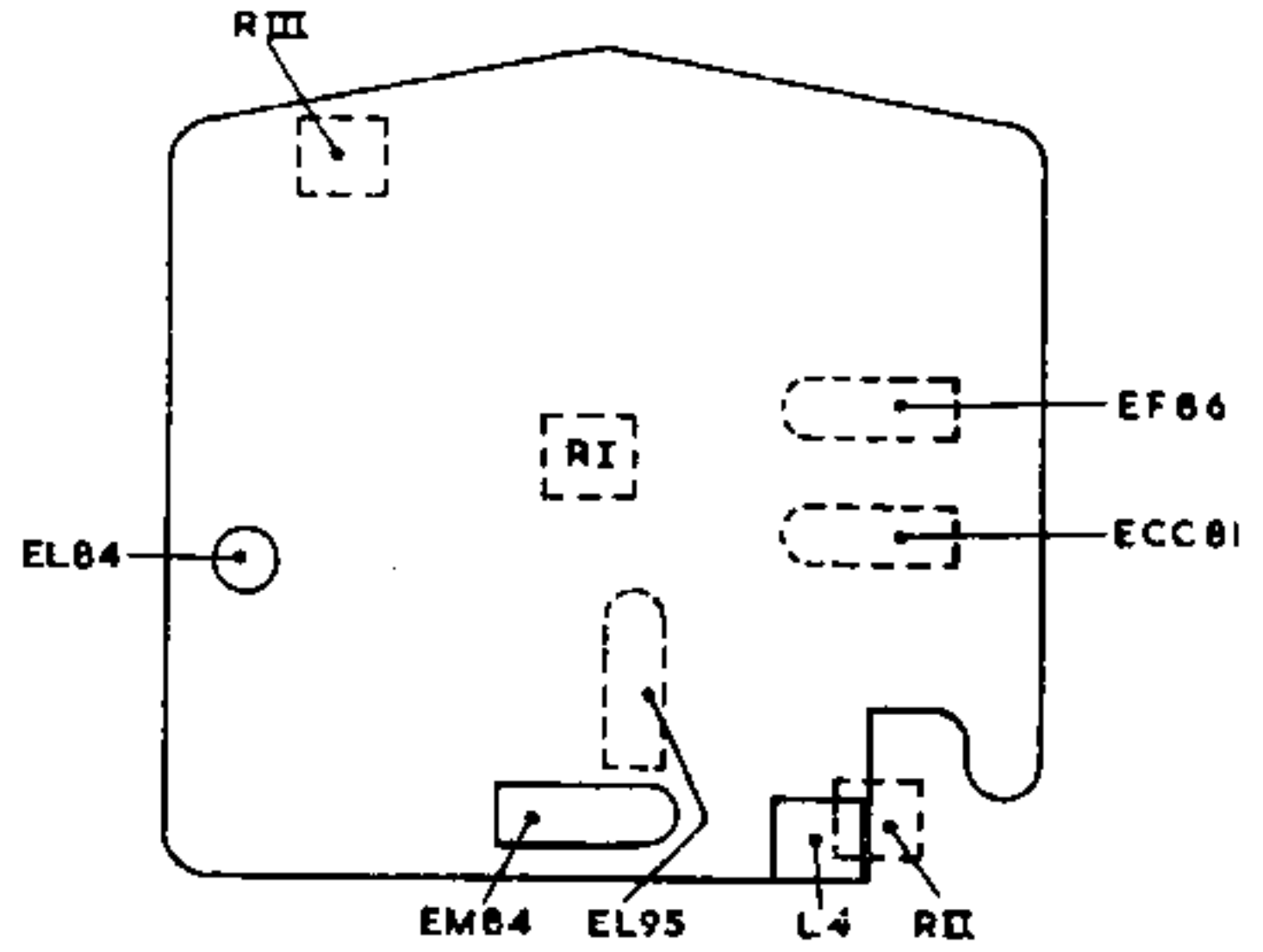
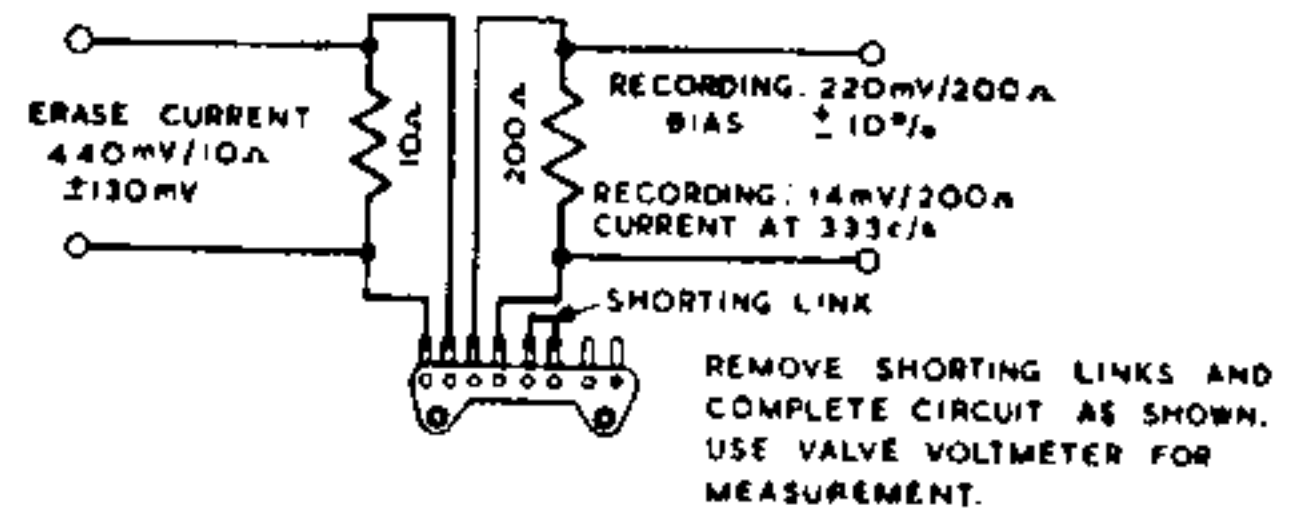

TWO-SPEED SWITCH

SPEED	2	4	13	15	21	19
3 3/4 i.p.s.			●			
7 1/2 i.p.s.	●				●	

SHOWN IN 3 3/4 i.p.s. POSITION

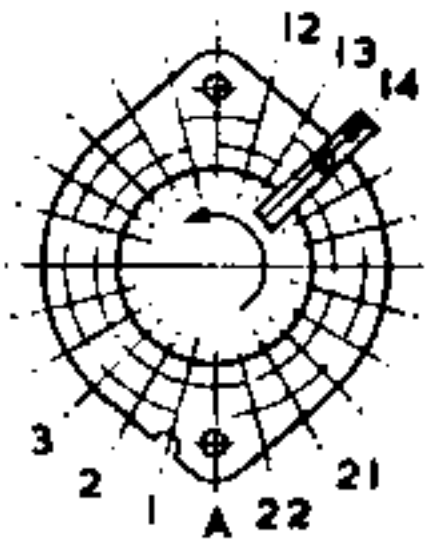

14th CONTACT COUNTED CLOCKWISE FROM POINT 'A' VIEWED FROM UNDER CHASSIS.

SOUND CHANNEL CONNECTIONS

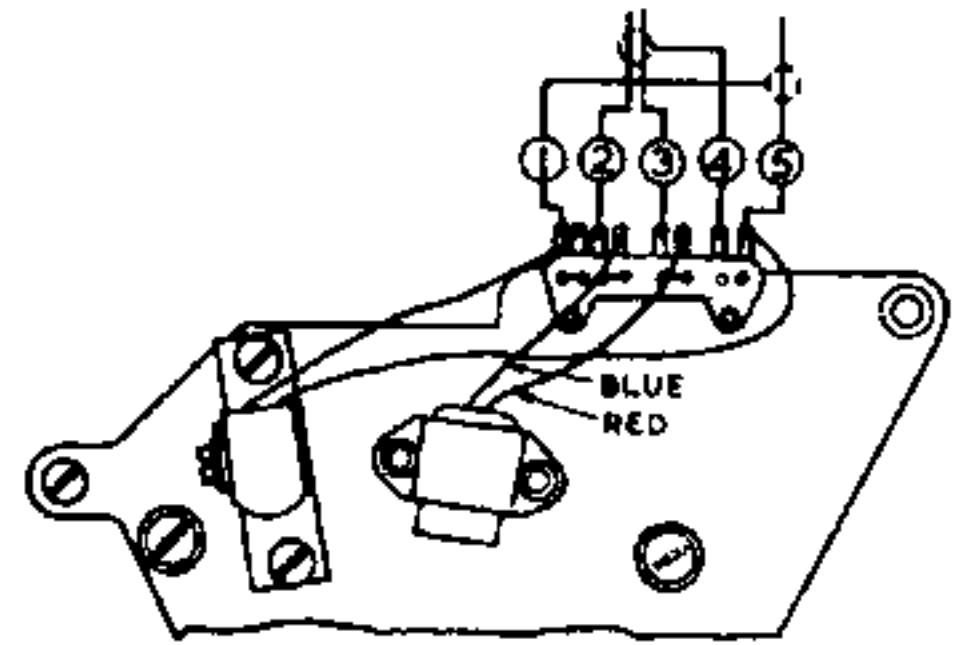

RELAYS

		COIL	PART No.	1	2	3	4	5	6	7	8	9	10
RI	AUTO-STOP RELAY	BV-012	127/136/1	O	O								
RII	RECORD RELAY	BV-9030-503	127/136/2	O	C/O	C	C/O	O	C/O	C/O	C	C/O	C/O
				127/399/11	127/399/12	127/399/11	127/399/13	127/399/10					
RIII	BRAKE RELAY	BV 9038-502	127/136/3	C									

C/O - CHANGE-OVER CONTACT
O - OPEN IN NON-ENERGISED POSITION
C - CLOSED IN NON-ENERGISED POSITION

L4 - PRESSURE SOLENOID

MISCELLANEOUS DETAILS—GRUNDIG MODEL TK30

attention other than occasional cleaning of felt clutch facings with methylated spirit. To take clutch apart: removal of large circular clutch spring ring will release upper clutch spindle, exposing circlip of upper clutch half. Remove this circlip and small washer and lift out clutch weight and upper clutch half. Felt inserts may now be cleaned.

Head Currents: H.F. bias current to head when recording is 1.1 mA. and may be measured across a 200-ohm resistor in series with chassis return lead, to give 220 mV. ± 10 per cent. on valve voltmeter. If figure is less than 200 mV., on TK30, C2 should be set to maximum and R3 set for optimum condition. On TK35 setting is governed solely by R3.

Erase current should be measured across 10-ohm resistor in chassis return lead and should be about 440 mV. on valve voltmeter. Recording current should read 14 mV. across 200-ohm resistor when 333-c/s. note is fed to diode input to give full modulation (EM85 closed); when making measurement remove EL95 and replace H.T. loading with 12k resistor.

Head Alignment: Positioning of record/playback head is very critical, particularly for reproduction of tapes made on other machines. Adjust on 6000-c/s. tape made on standard machine with valve voltmeter to high-impedance output. Two head screws, one spring loaded, should be adjusted for maximum output.

Hum Level: Adjust R43 for minimum hum level.

Fault-finding: The notes given for Models TK20, TK25 in the 1959-60 volume will be found generally applicable.

Recording Level Indicator: Feed 333-c/s. signal to diode output with recording level control at maximum, and adjust input level until voltage on playback measured at high-impedance output with valve voltmeter is 630 mV. The indicator should just close at this figure (set by R38) and the input should be not more than 1.5 mV. \pm 2 db.

Mechanical Notes: It is most important that the tape is guided in a straight line along its full length of travel, and correct adjustment of the tape guides is very critical. After carrying out any adjustment to the tape transport system all screws must be resealed with insulating varnish or sealing lacquer.

Pressure of the pressure roller against capstan spindle should correspond to pull on tape of about 18 oz. with motor running. Adjustment for correct pressure of roller may be made by the eccentric adjusting screw on end of pressure-roller arm. Both pressure roller and capstan spindle should be absolutely vertical and parallel to each other.

The tape pressure against record/playback head should be about 1 oz. The pressure pad should sit squarely and centrally when engaged.

Uneven pull from either spool spindle or jerkiness may be due to dirt on felt insert under corresponding upper clutch half. Felt may be cleaned with methylated spirits, using small brush. It is also permissible to roughen felt with piece of fine sandpaper.

All bearings are self-lubricating, but it is recommended to check lubrication after about 500 hours use. Shell Vitrea Oil No. 21 is recommended, but should be used sparingly and with care.

Dirt on pressure roller or capstan will increase wow, and may cause tape to jump out of guides. Remove dirt from roller by holding piece of fine sandpaper while rotating. Crocus paper is recommended for cleaning capstan.