

Grundrig 8060 WF/3 D (8060/56), Musikschrank

Ned. Ver. v. Historie v/d Radio

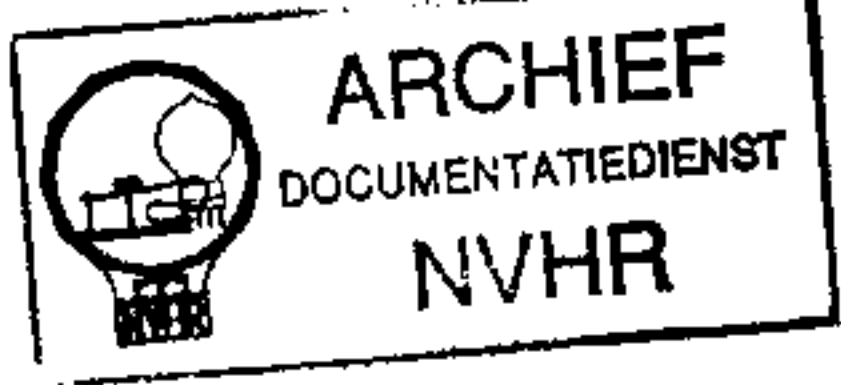

(I. Teil des Schaltbildes)

EF 89

ECH 81

ECC 85

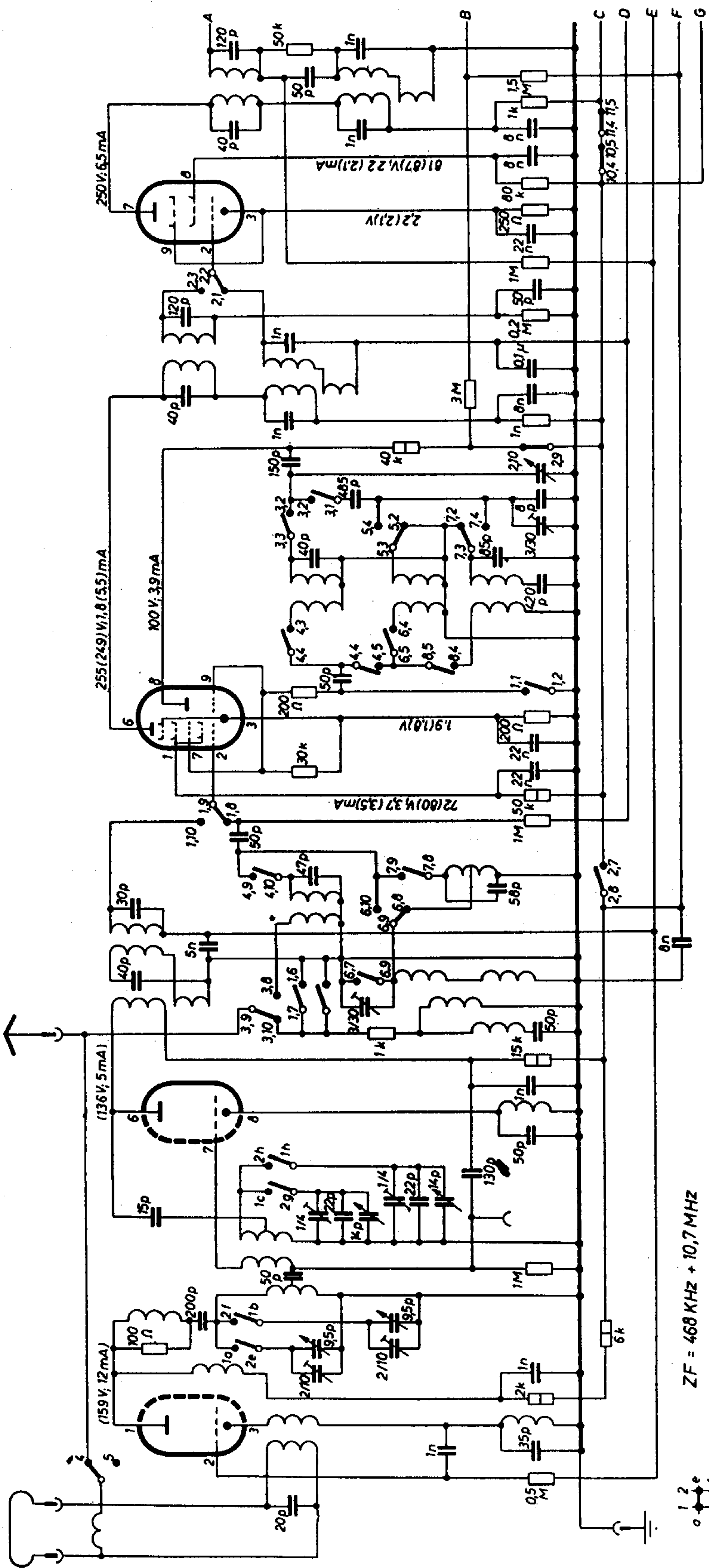

Ⓟ Röhrevoltmeter, Meßwerte bei MW(UKW)

ZF = 468 KHZ + 10,7 MHz

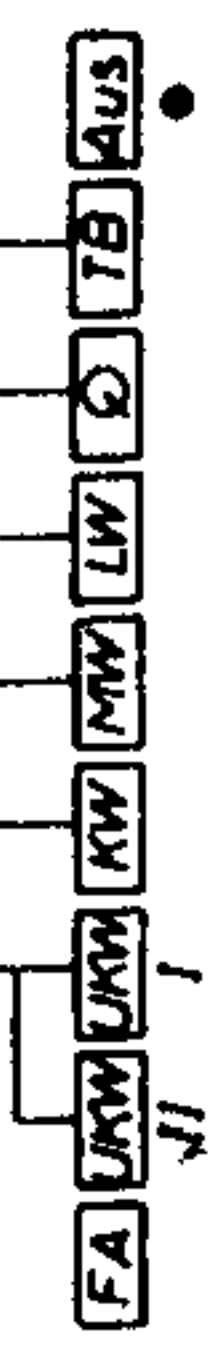
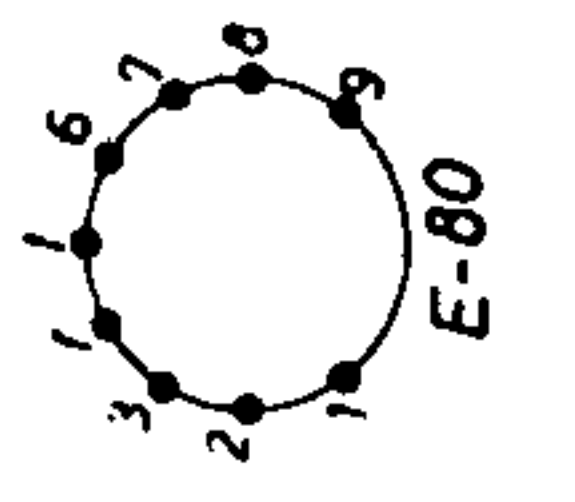
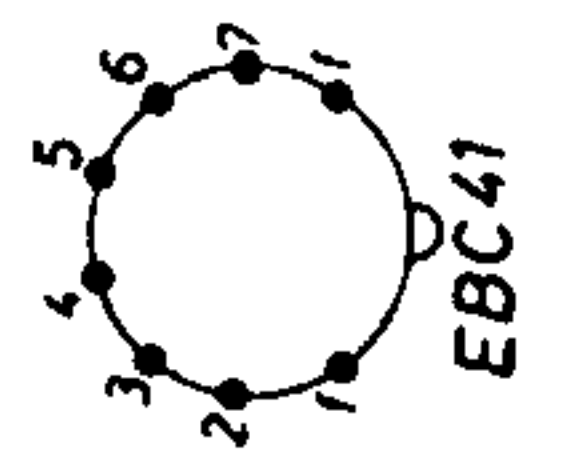
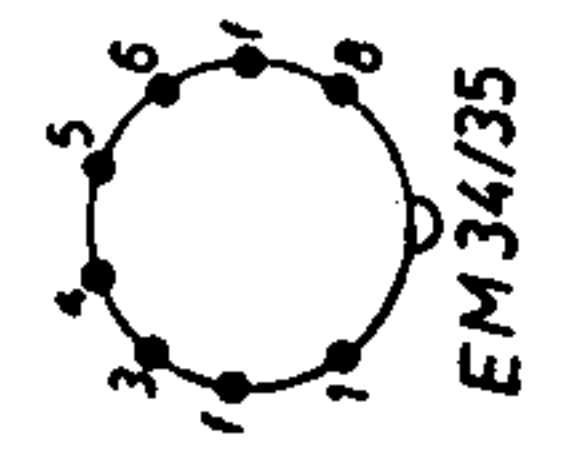
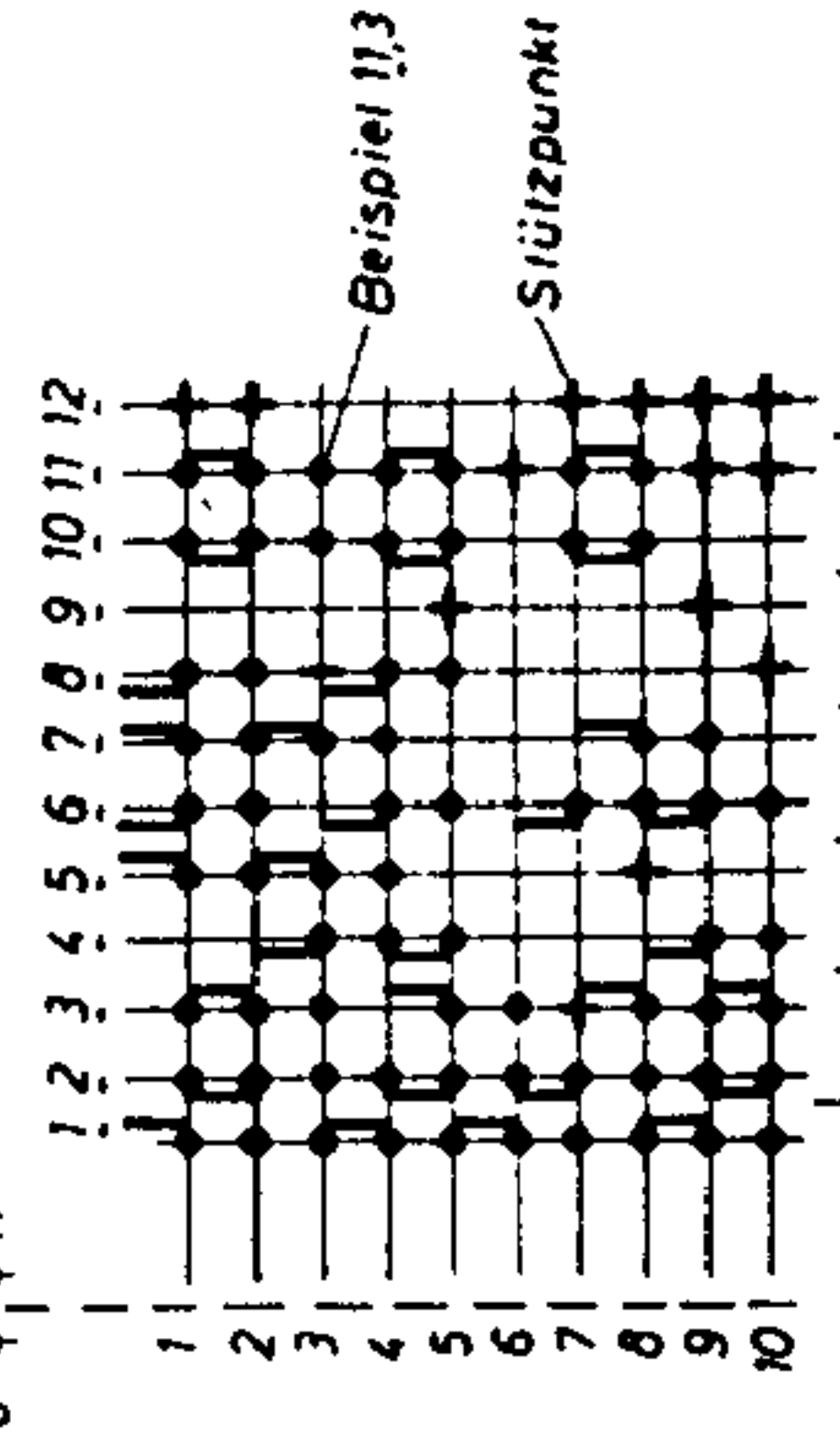
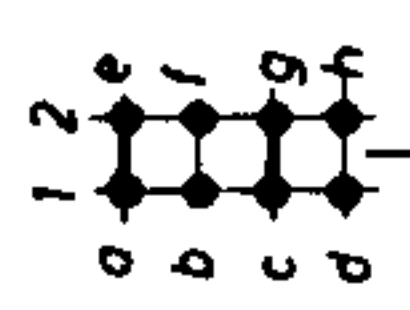

(2. Teil des Schaltbildes)

