

Ned. Ver. v. Historie v/d Radio

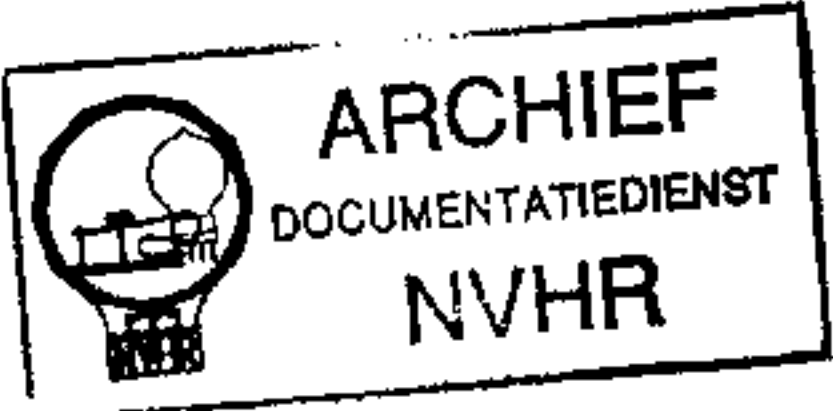

Met dank aan Heinz Sultz

Röhrenbestückungs- und Heizkreisplan
 Ansicht von der Seite der Leiterbahnen
TUBE LOCATION GUIDE AND FILAMENT CIRCUIT
 VIEWED ON THE SOLDER SIDE

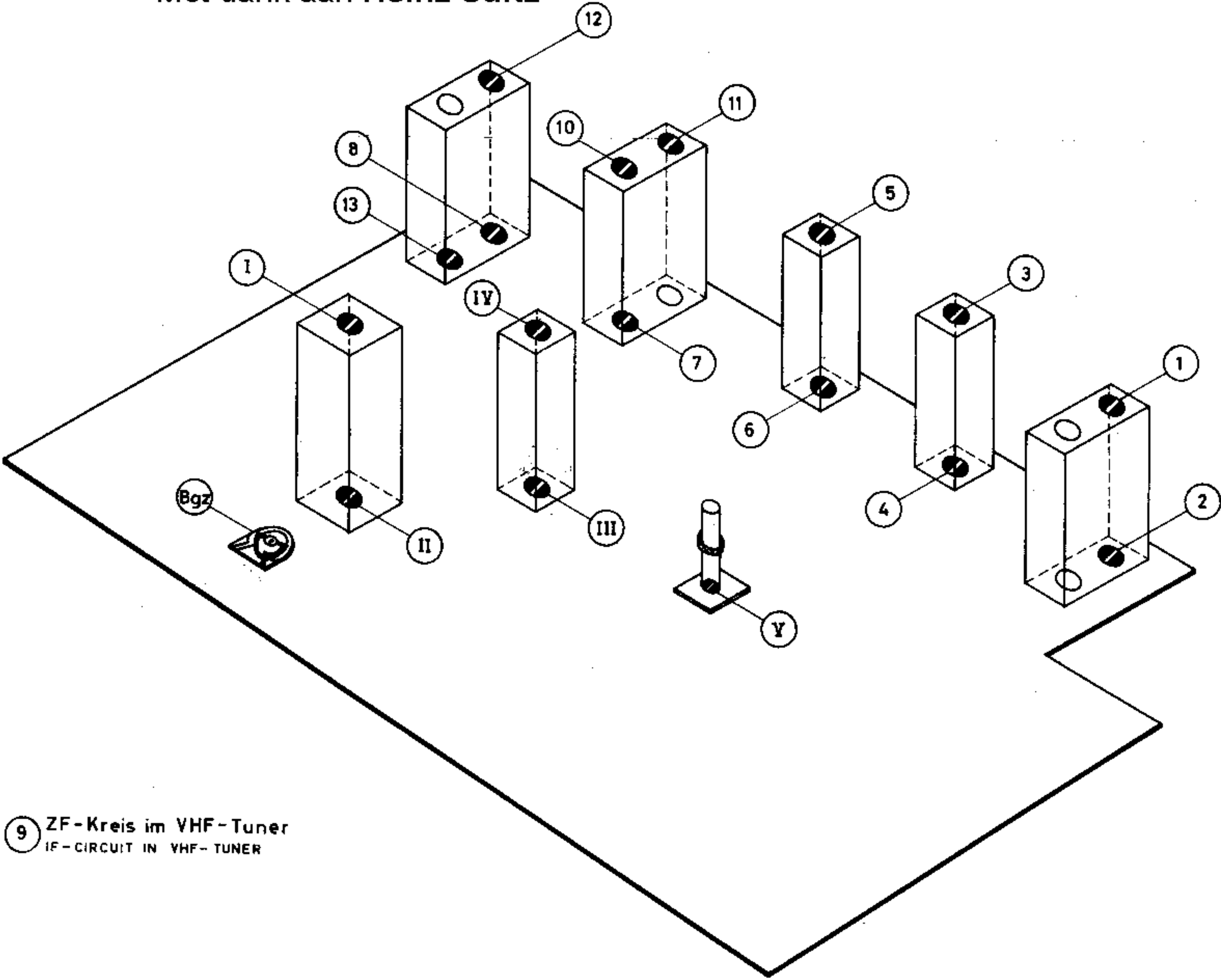

9 ZF-Kreis im VHF-Tuner
 IF-CIRCUIT IN VHF-TUNER

Lageplan der Abgleichkerne
LOCATION GUIDE FOR ALIGNMENT CORES

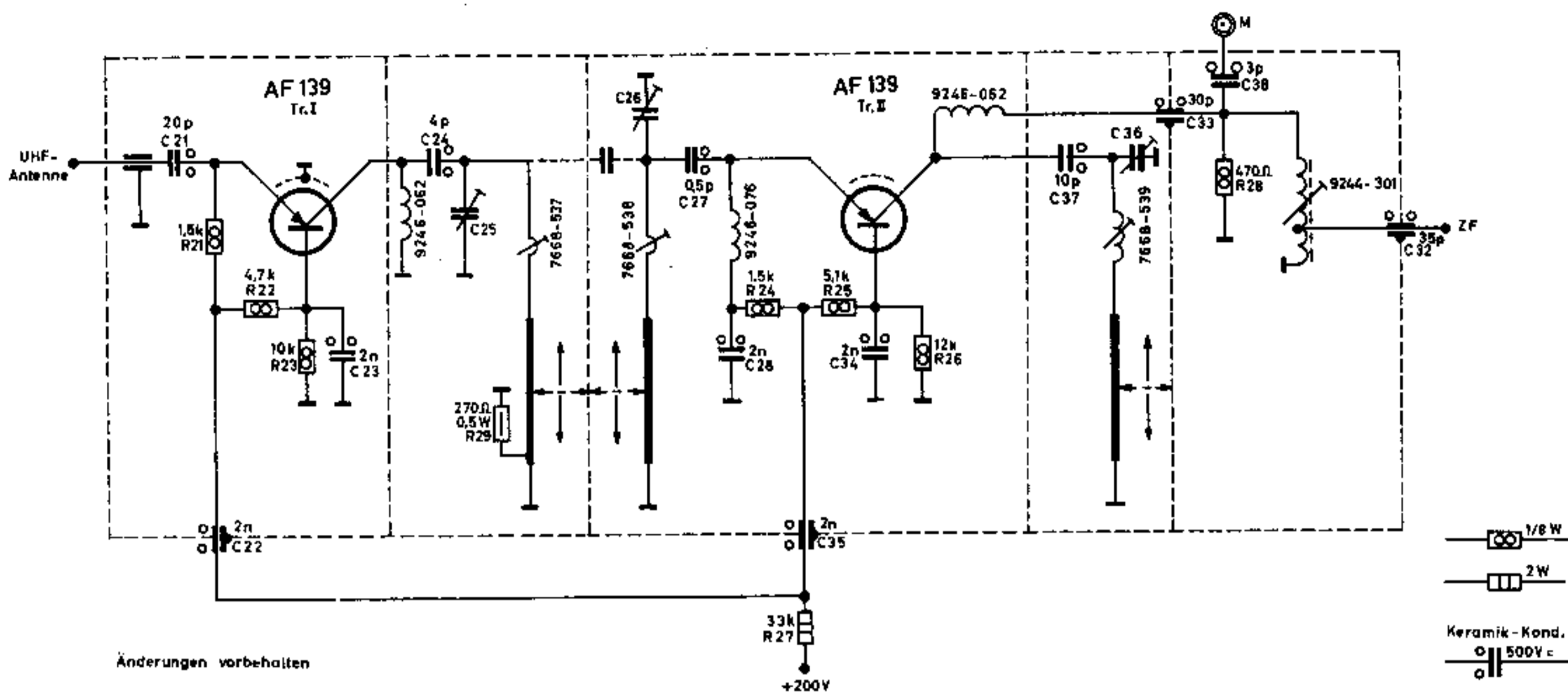

UHF-Kanalwähler 22

UHF CHANNEL SELECTOR 22

**Lage der Hilfsregler
PLACEMENT CHART OF CONTROLS**

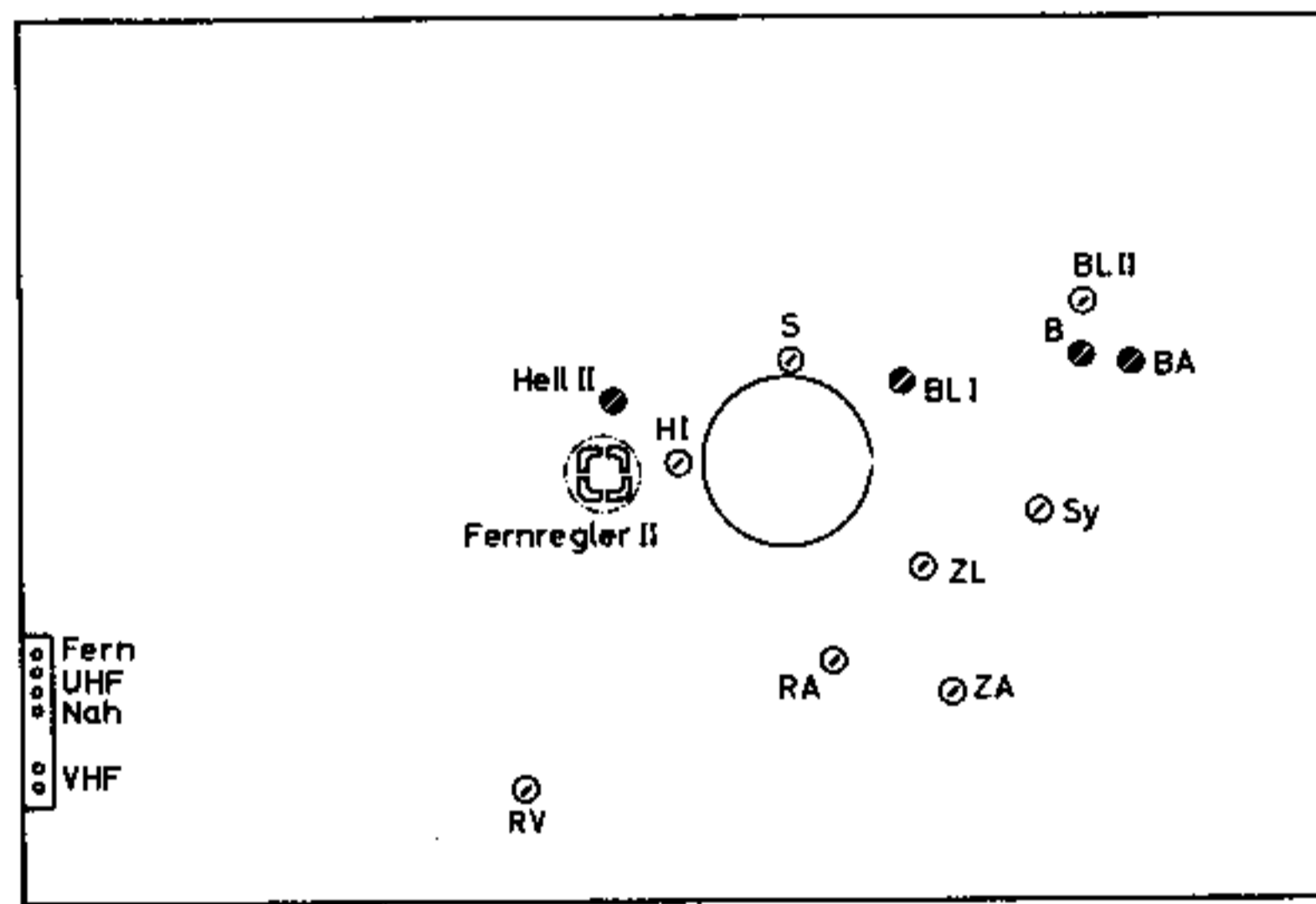
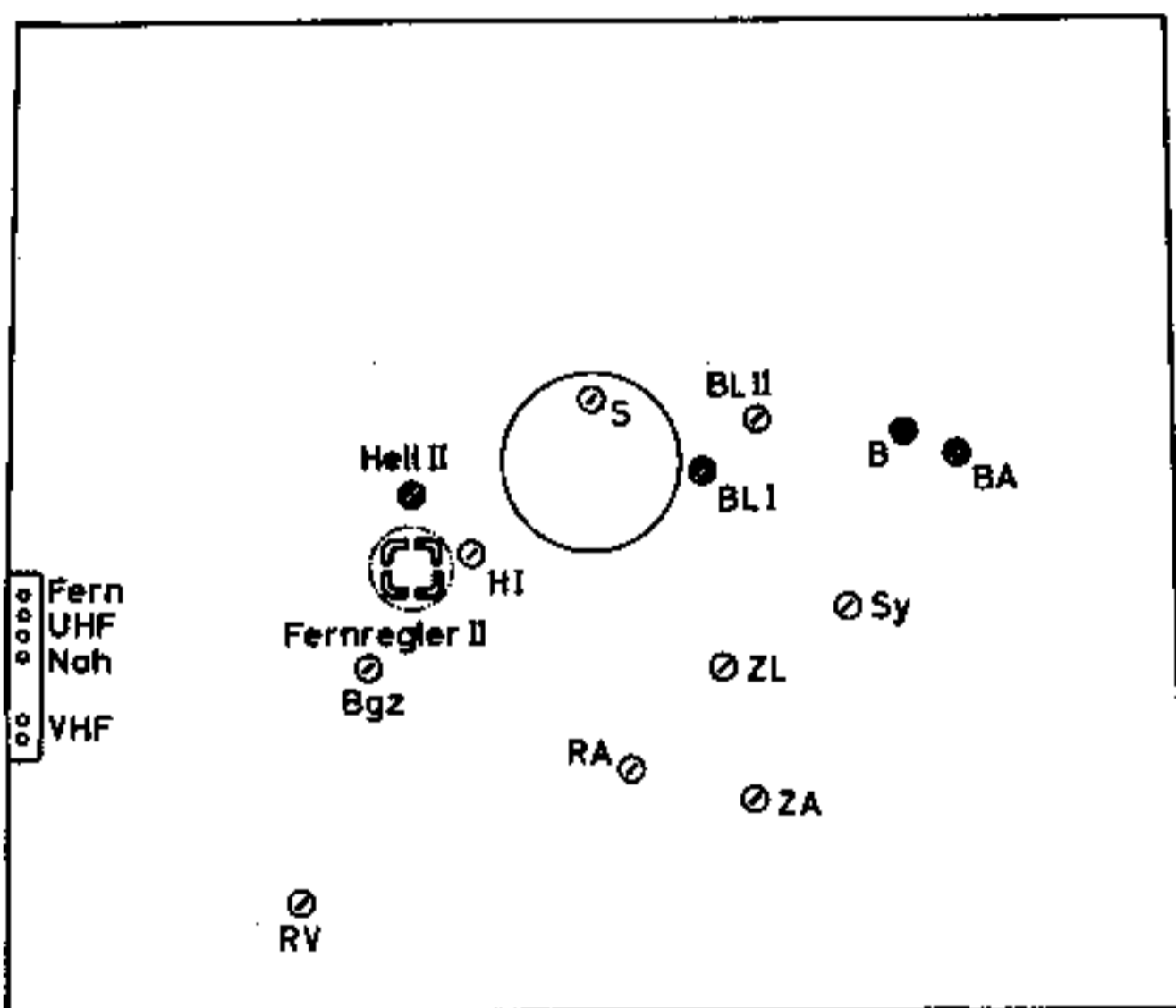

- B = Bildfrequenz
vert. hold, adjustment
- BA = Bild-Amplitude
(Bildhöhe)
Vert. amplitude
(vert. size control)
- Bgz = Begrenzung
Limitation
- BL I = Bild-Linearität
(Gesamtbild)
vert. linearity control I
- BL II = Bild-Linearität
(am oberen Bildrand)
vert. linearity control II
- H I = Grundhelligkeit (VHF)
basic brightness/VHF
- H II = Grundhelligkeit (UHF)
basic brightness/UHF

- RA = Regelspannung Arbeitspunkt
operating point of AGC
- RV = Regelspannungs-Verzögerung
delay of AGC
- S = Punktschärfe
focus
- Sy = Symmetrieregler
(Zeilenfrequenz)
symmetry control
- ZA = Zeilenamplitude
(Bildbreite)
horiz. amplitude
horiz. size control
- ZL = Zeilen-Linearität
horiz. linearity control





GRUNDIG
WERKE GMBH FURTH (BAY.)
300K10
 (24-4123-1101/S)

Alle Spannungen, Ströme sind gemessen mit VHF-Signal bei max. Kontrast; mittl. Halbleiter, 220V Netzspannung und mit GRUNDIG Universal-Rehranometer.
 THE INDICATED VOLTAGES AND CURRENTS ARE MEASURED WITH GRUNDIG WAVE VOLTMETER WITH VHF-SIGNAL AT MAX. CONTRAST; MEDIUM BRIGHTNESS, AND 220V MAINS SUPPLY.

Bezeichnung der Röhren nach dem IEC-Code für die Kontakte der Röhrensockel
 von unten gesehen
 VIEWED FROM BELOW

Abgleichkerne
 ALIGNMENT CORES
 = ON TOP
 = ON LOWER

Key mark / CERAMIC
 C 125 V.
 O 500 V.
 G 500 V.
 S 500 V.

Styrolux
 125 V.
 500 V.

Paper u. Folienkondensatoren
 PAPER AND FOIL CAPACITORS
 125 V.
 500 V.
 630 V.
 1000 V.



Änderungen vorbehalten
 SUBJECT TO ALTERATION

PRINTED IN GERMANY