

Emud Condor MN (Oszillogramme siehe S. 309)

(I. Teil des Schaltbildes)

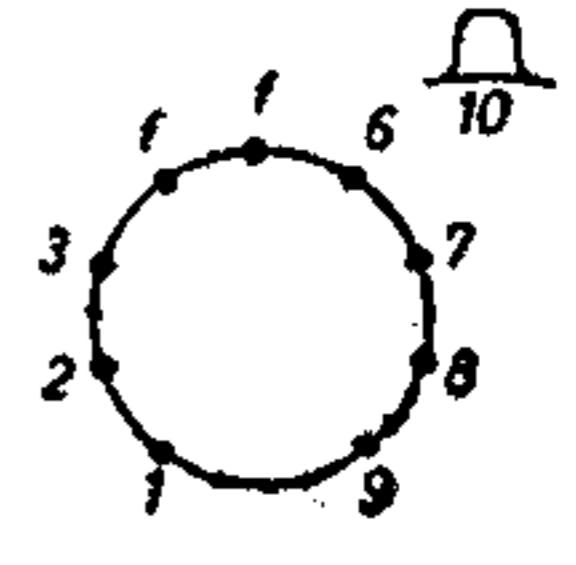

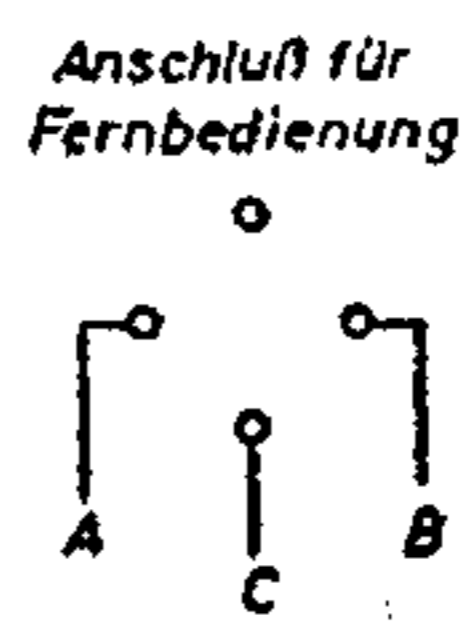
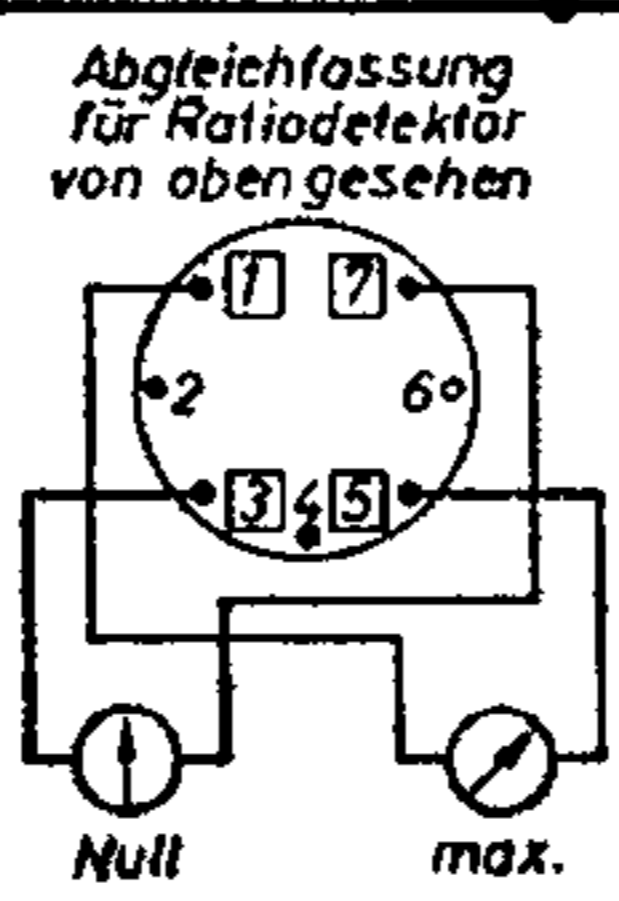
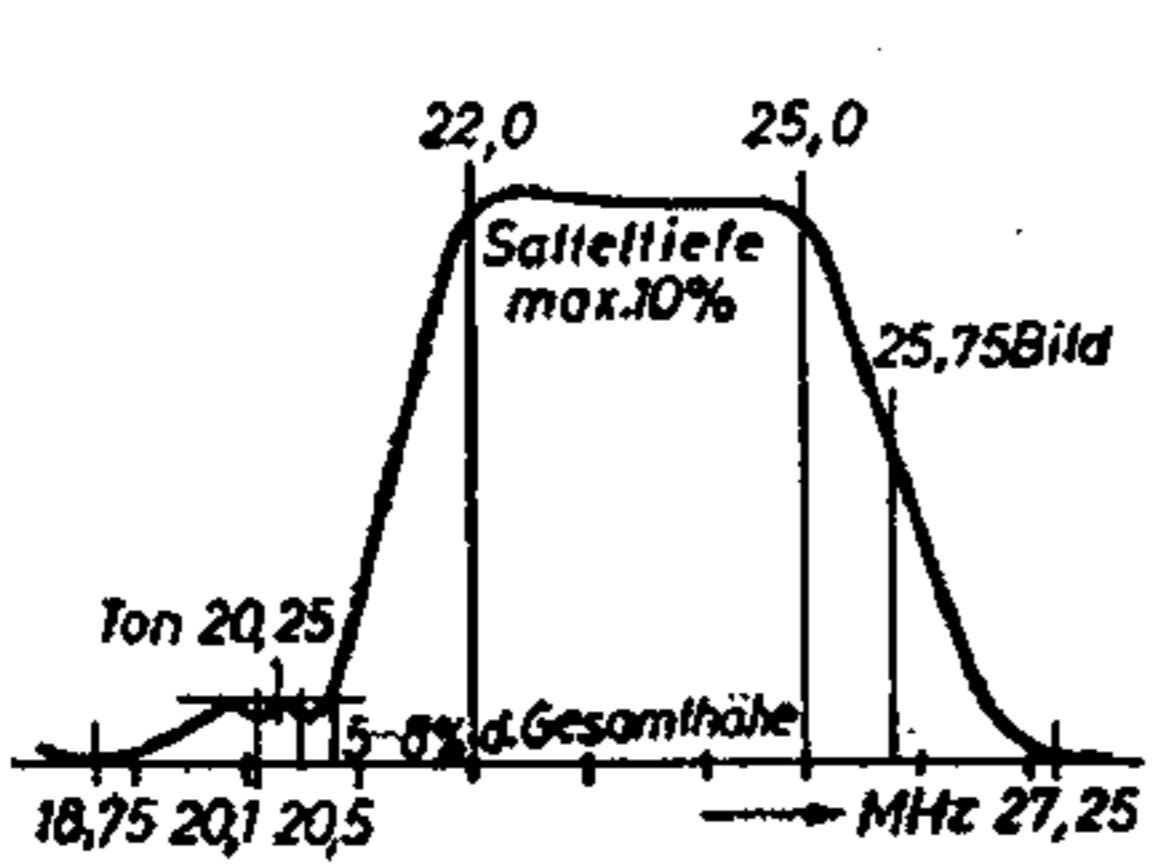
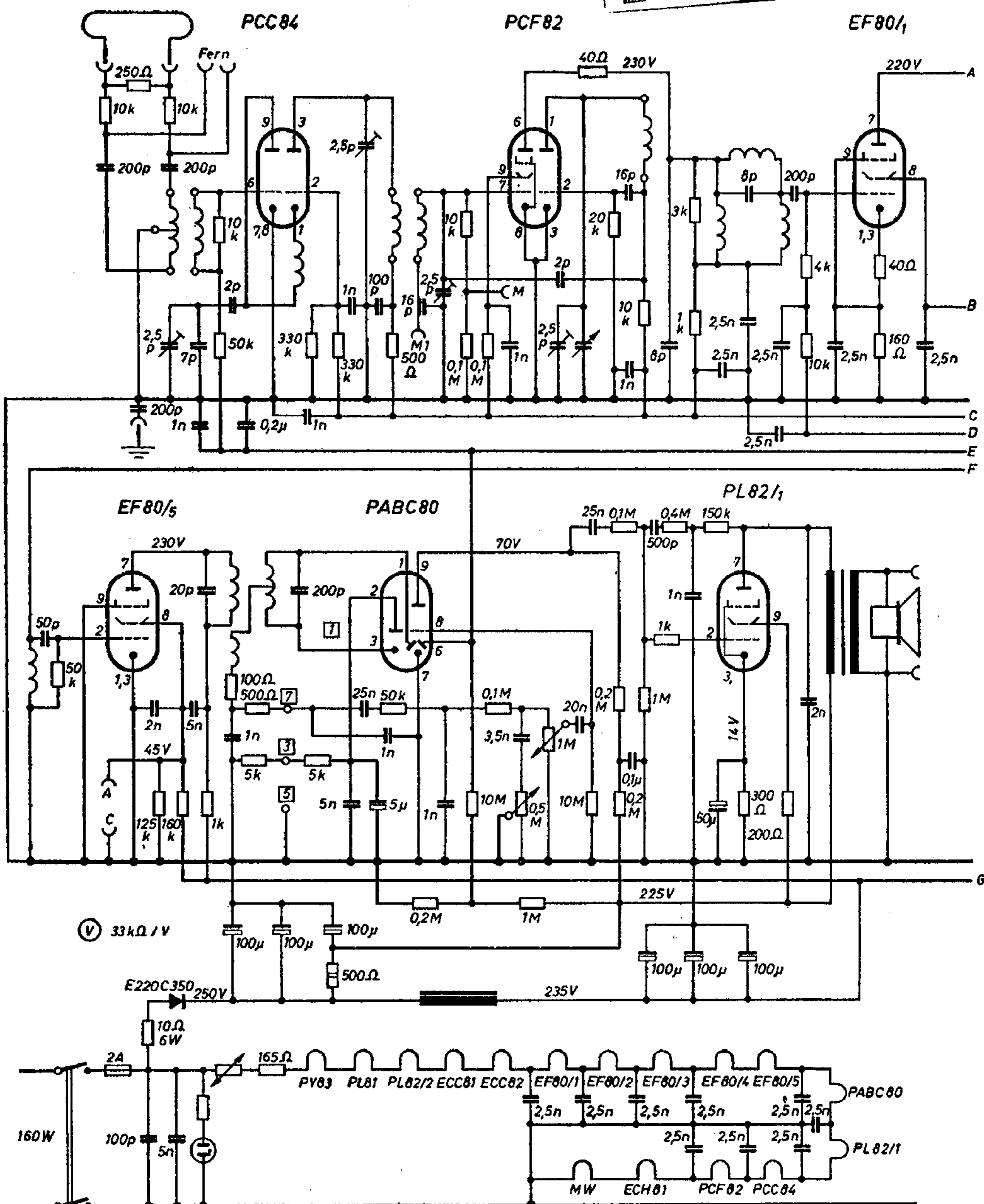
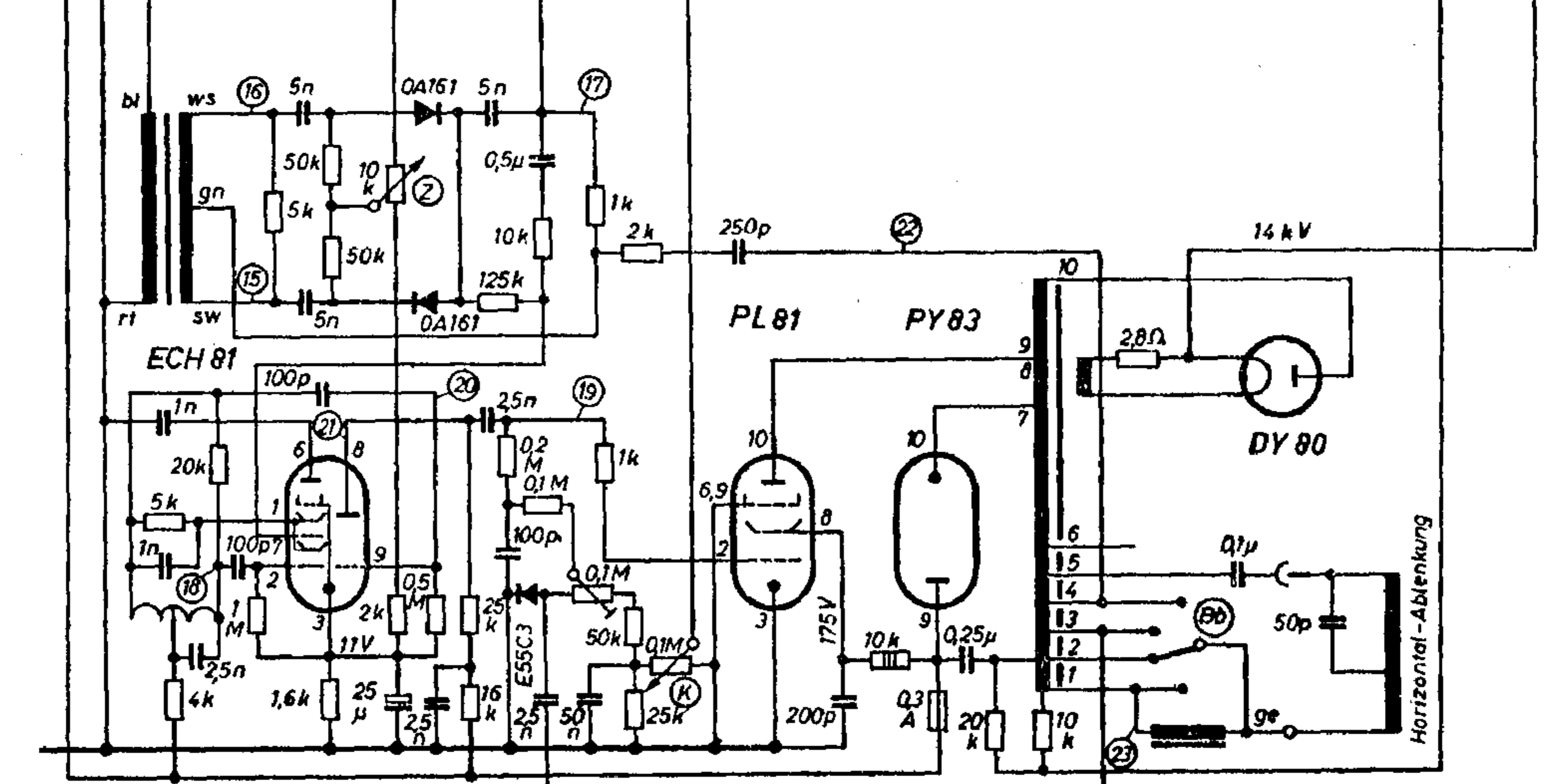
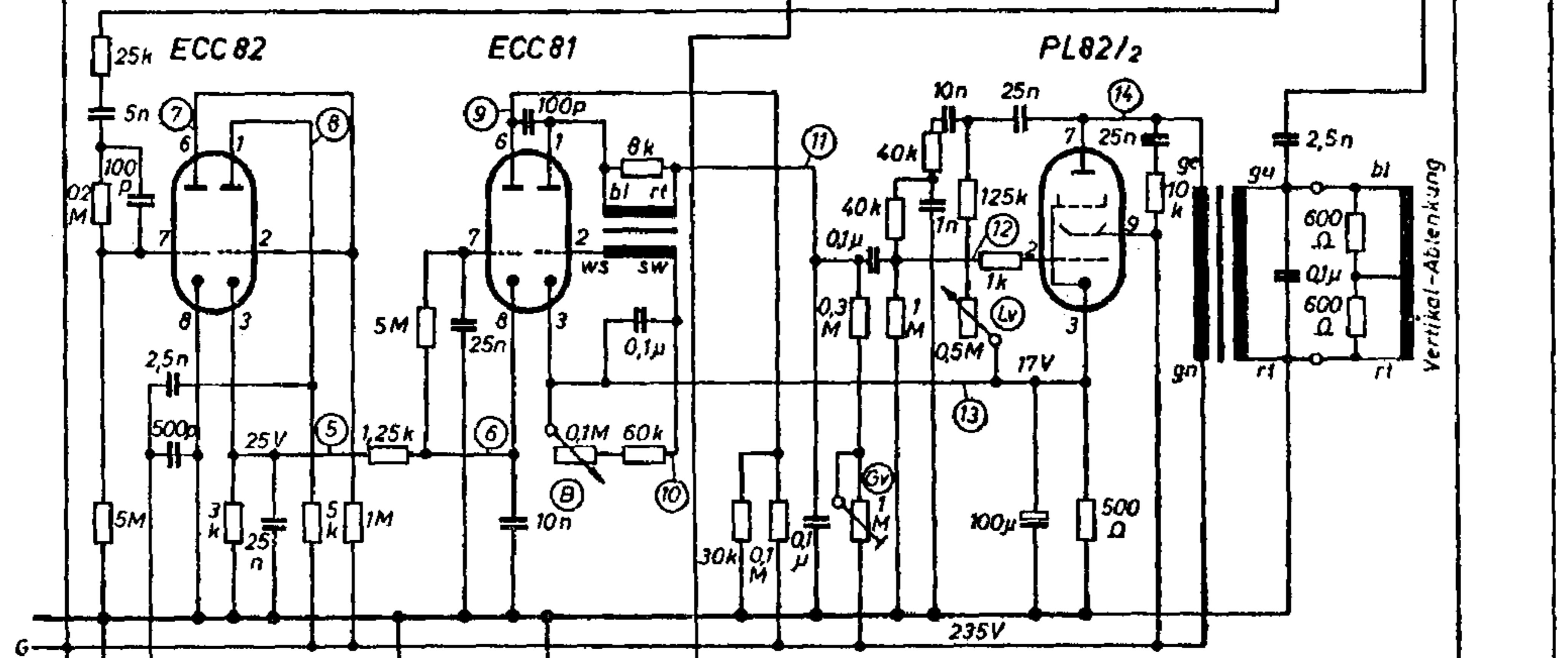
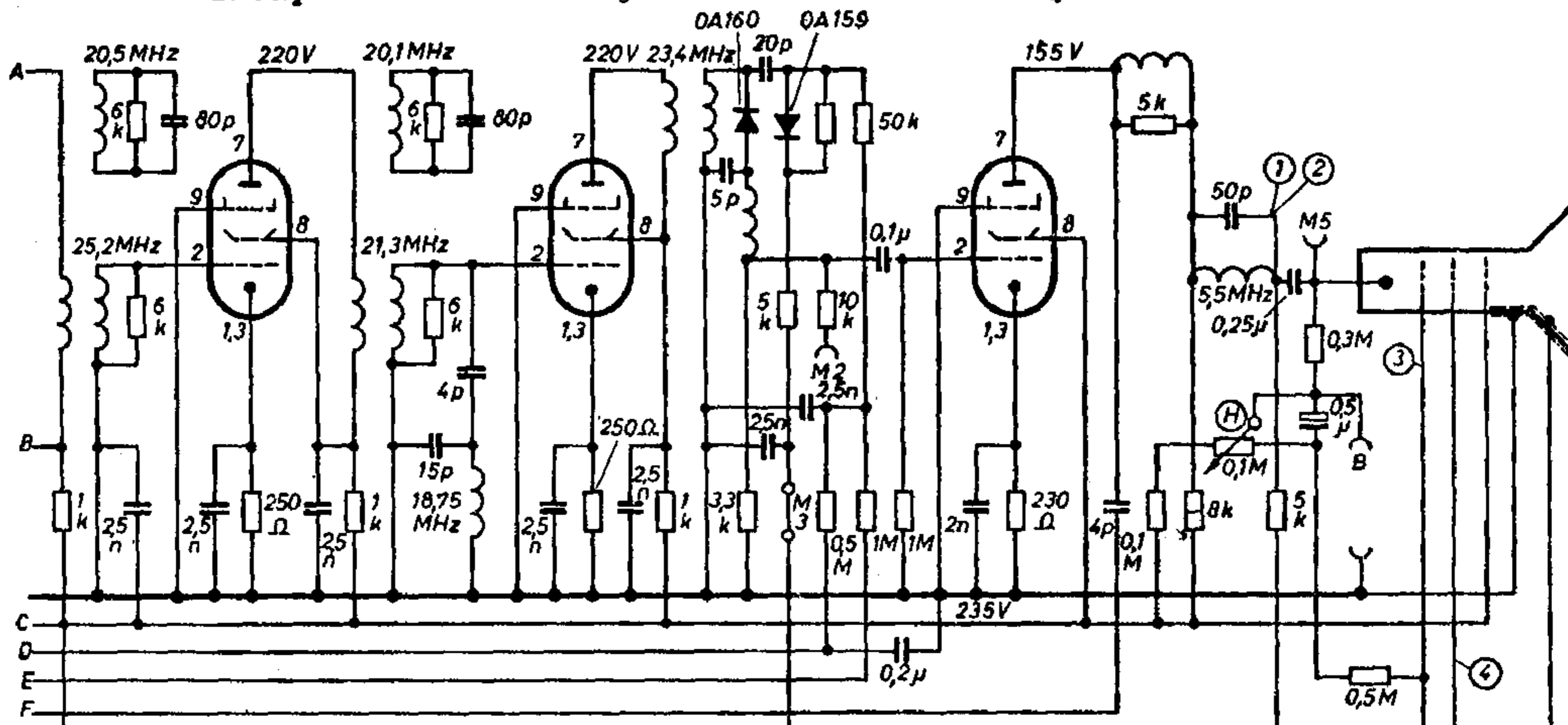

Oszillogramme zu Emud Condor MN (s. 910)



1



2



3



4



5



6



7



8



9



10



11



12



13



14



15



16



17



18



19



20

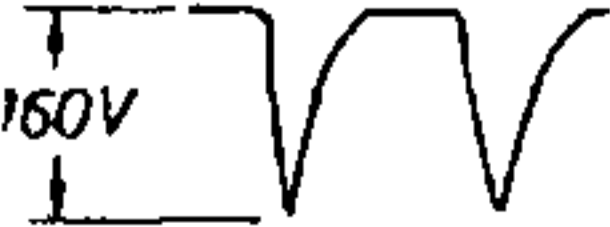

21



22



23