

MASTER OSCILLATOR
PART NO. 005 012B

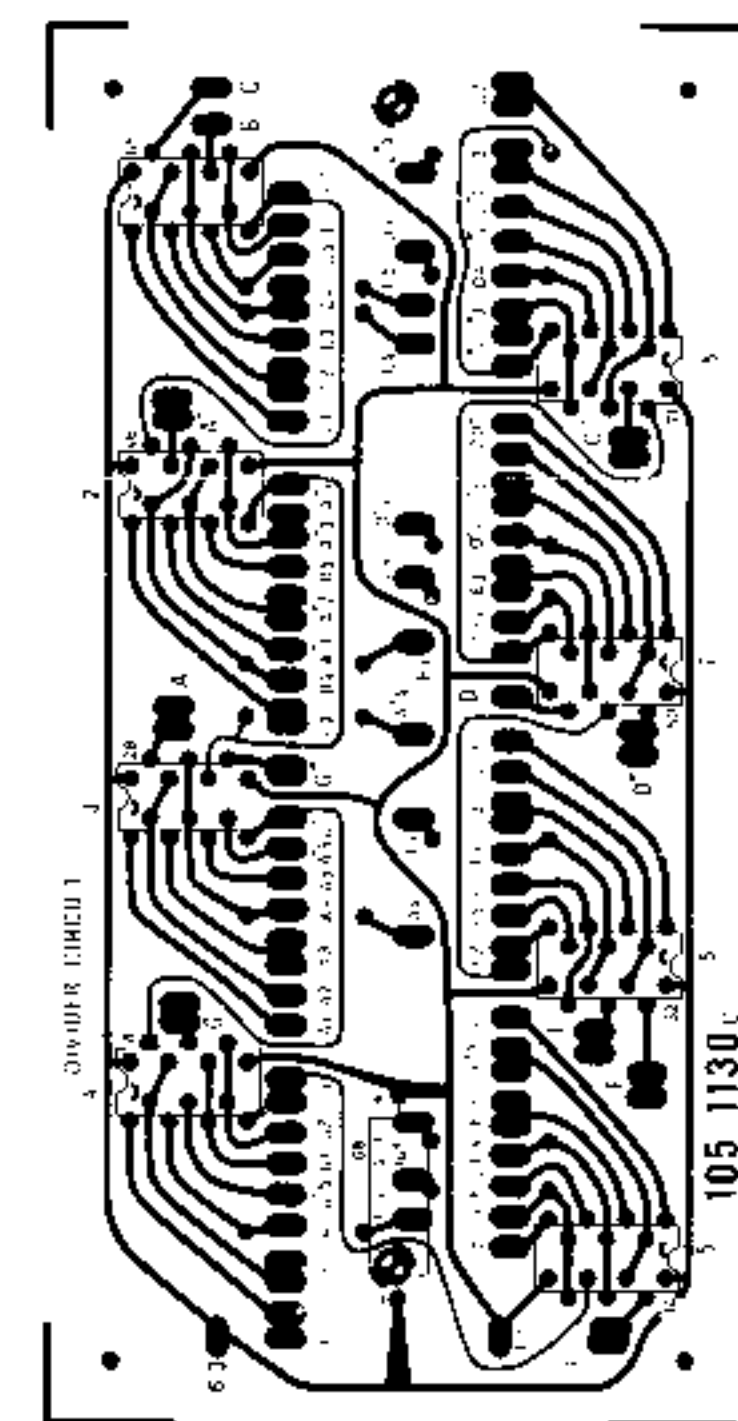

DIVIDER CIRCUIT
PART NO. 005 013C

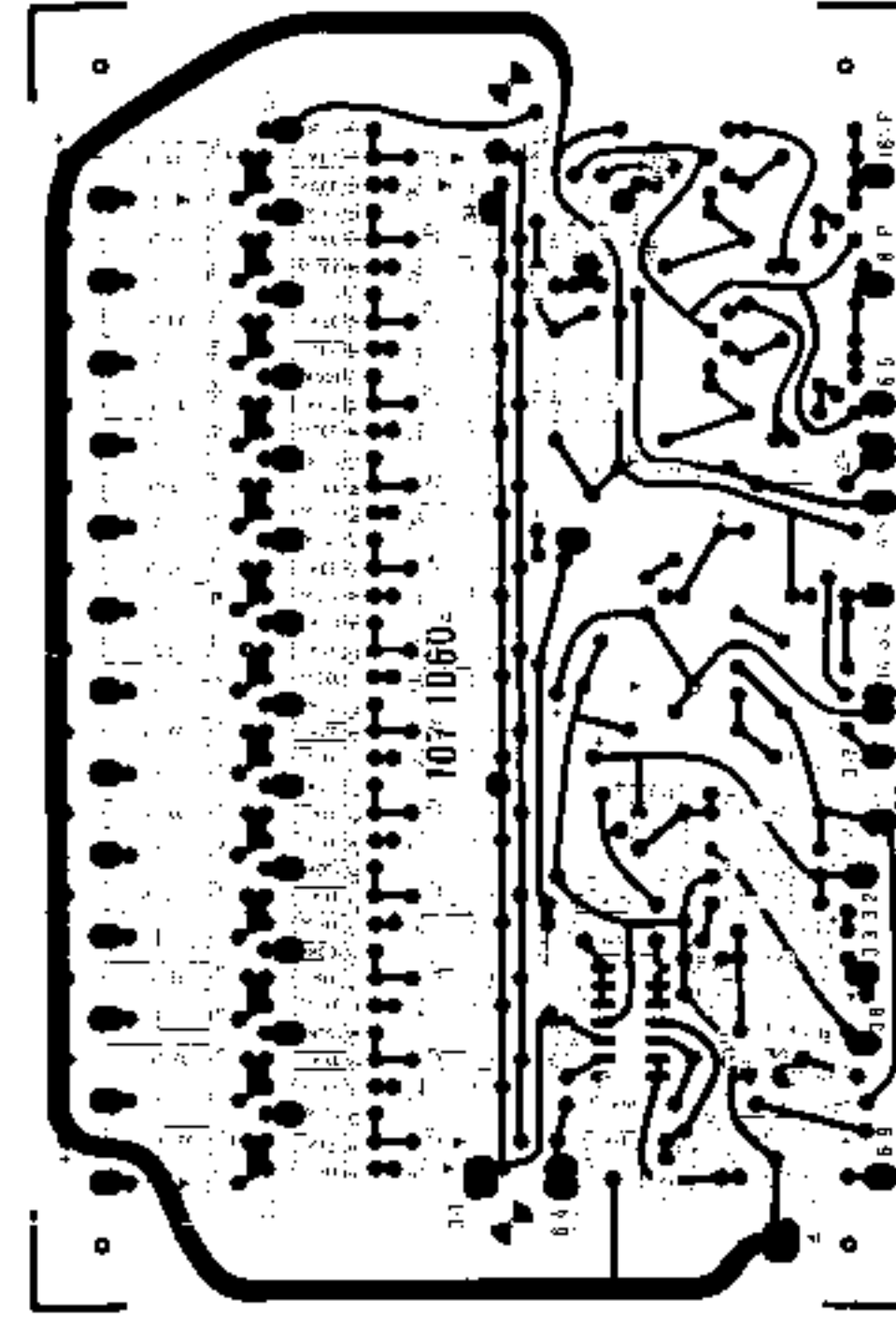

P.C.A. SUSTAIN CIRCUIT
PART NO. 005 016E

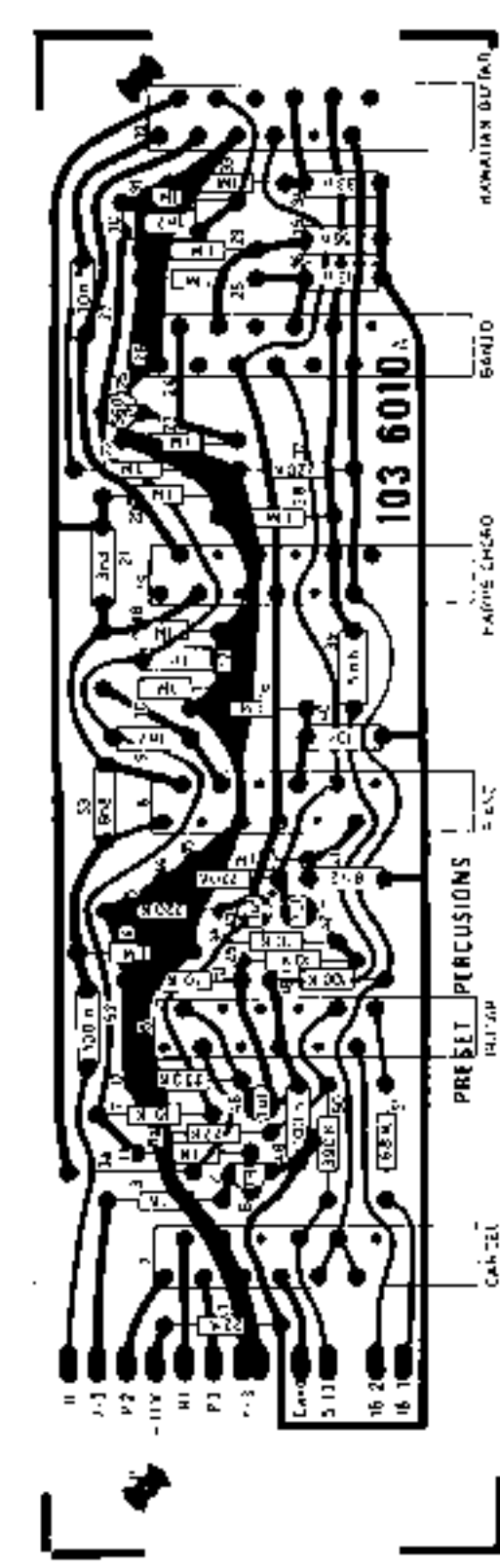

PRESET PERCUSSIONS
PART NO. 003 231A

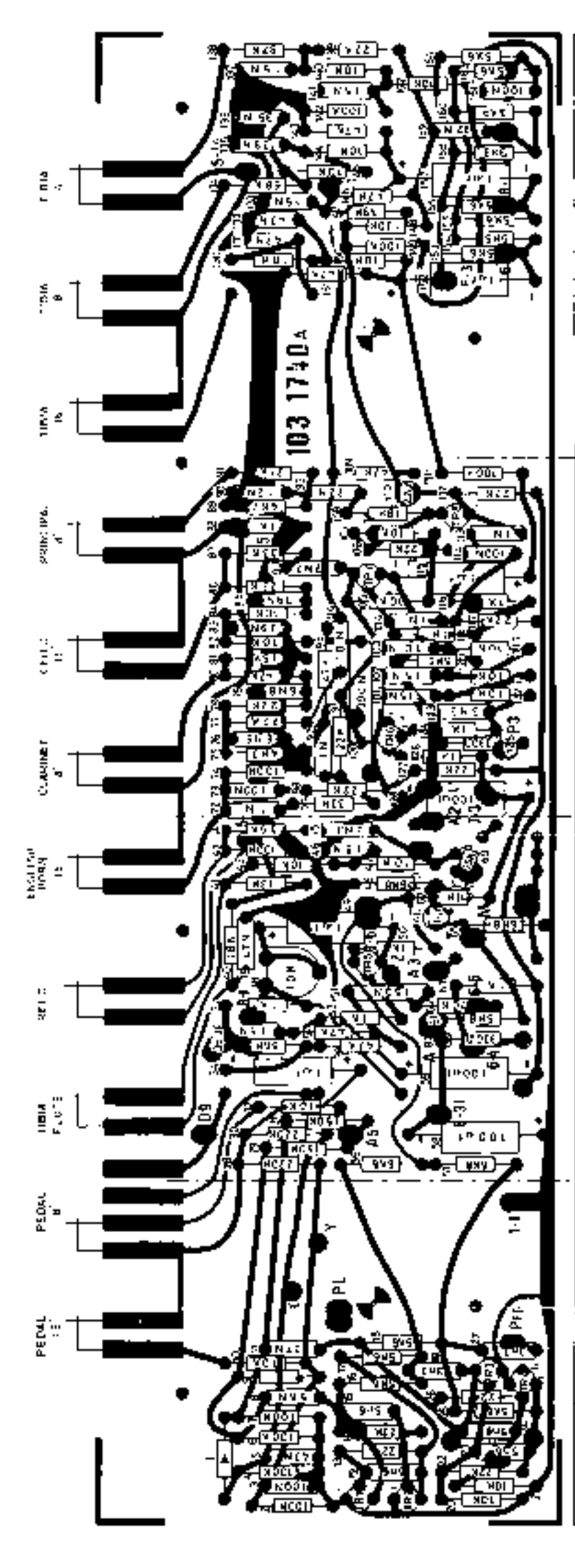

REGISTER CIRCUIT
PART NO. 003 231B

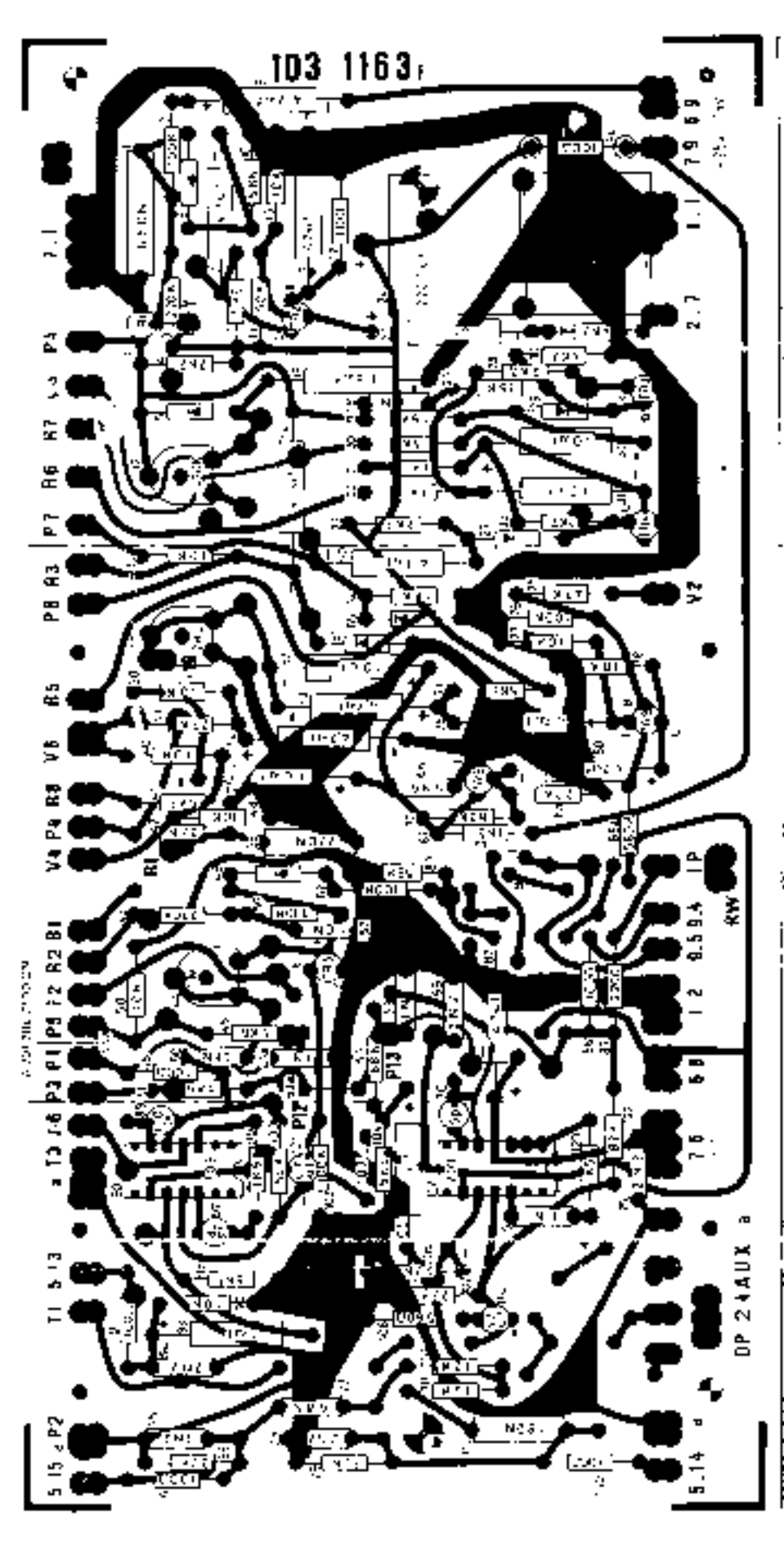

EFFECTS CIRCUIT
PART NO. 003 231D

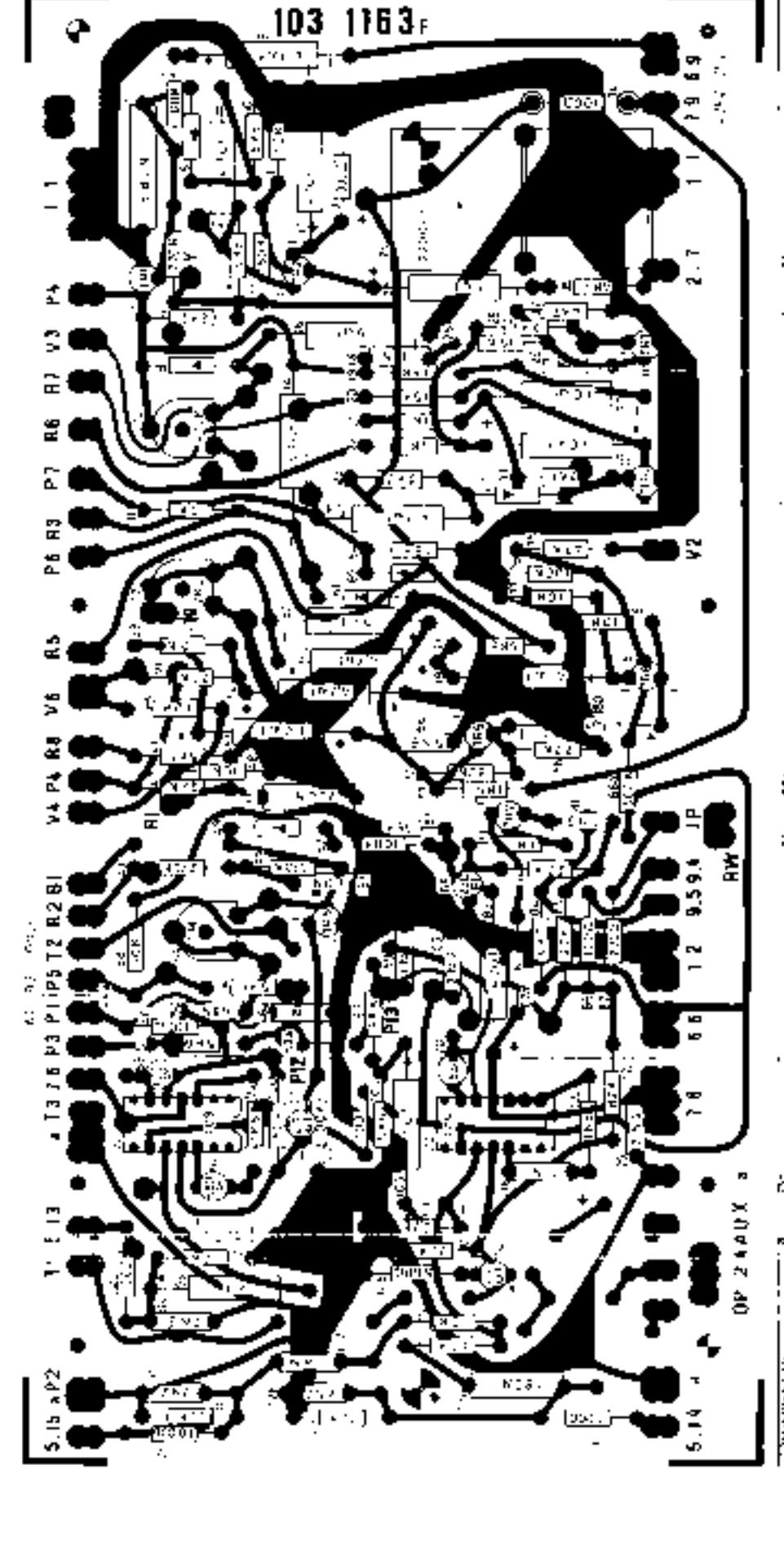

EFFECTS CIRCUIT
PART NO. 003 231B

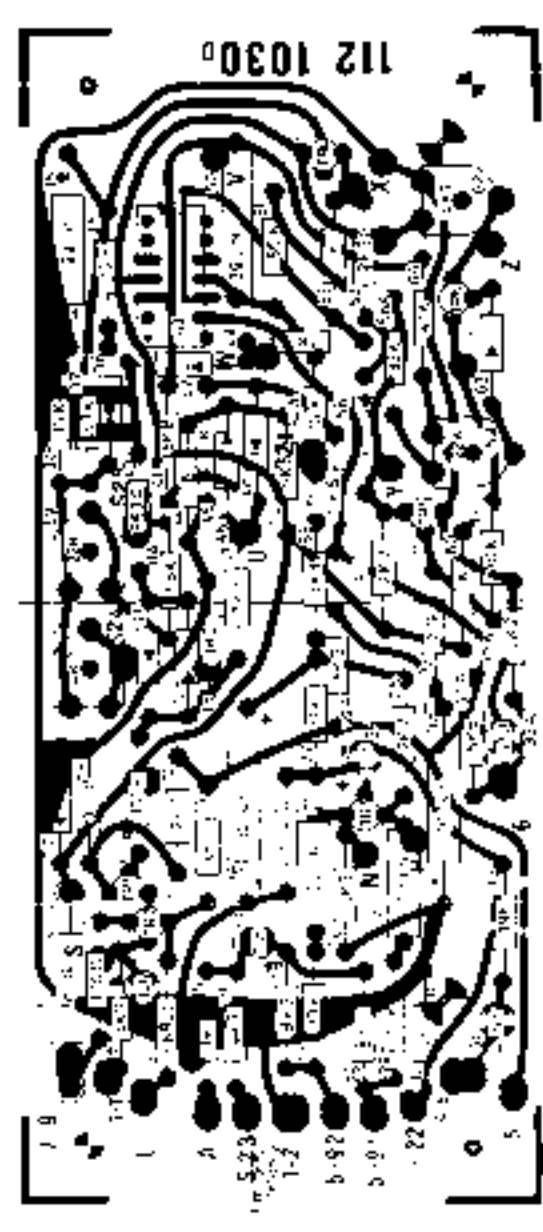

CONTROL CIRCUIT (OPTIONAL)
PART NO. 005 013D

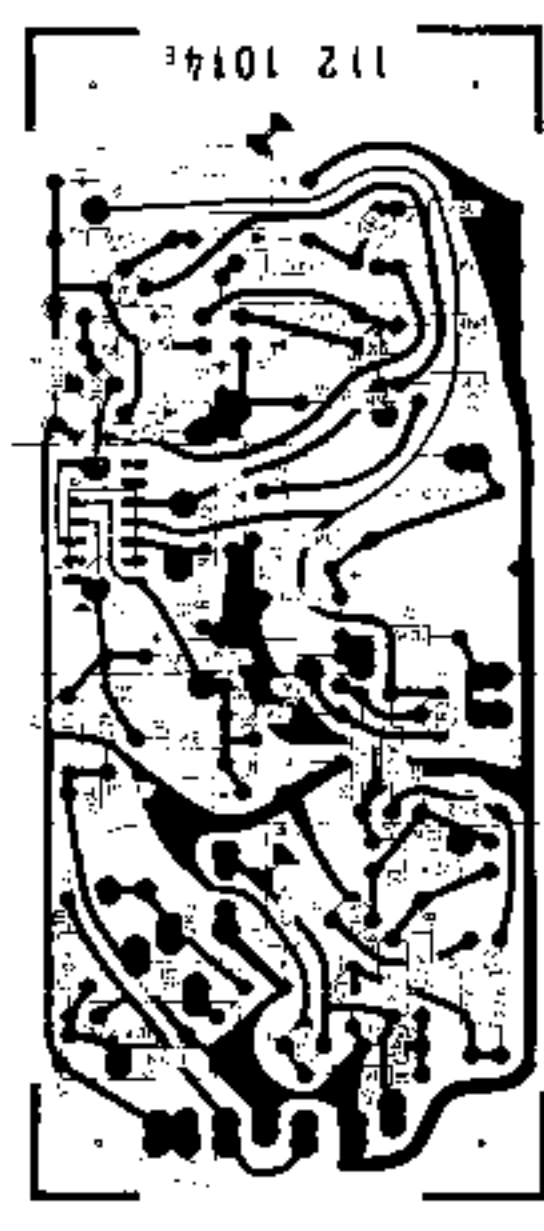

MODULATOR CIRCUIT C (OPTIONAL)
PART NO. 005 003B

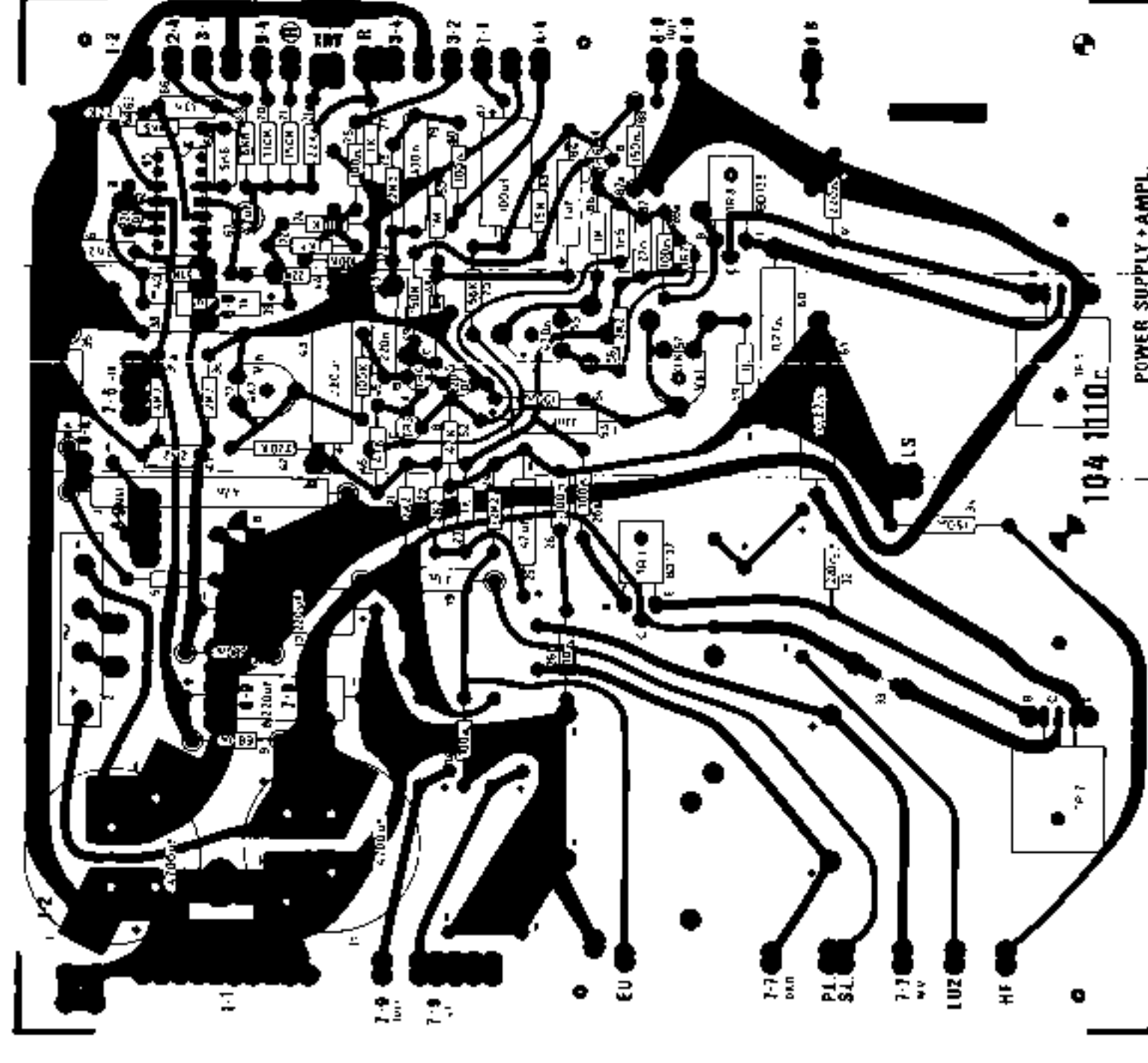

AMPLIFIER 50W
PART NO. 004 0099

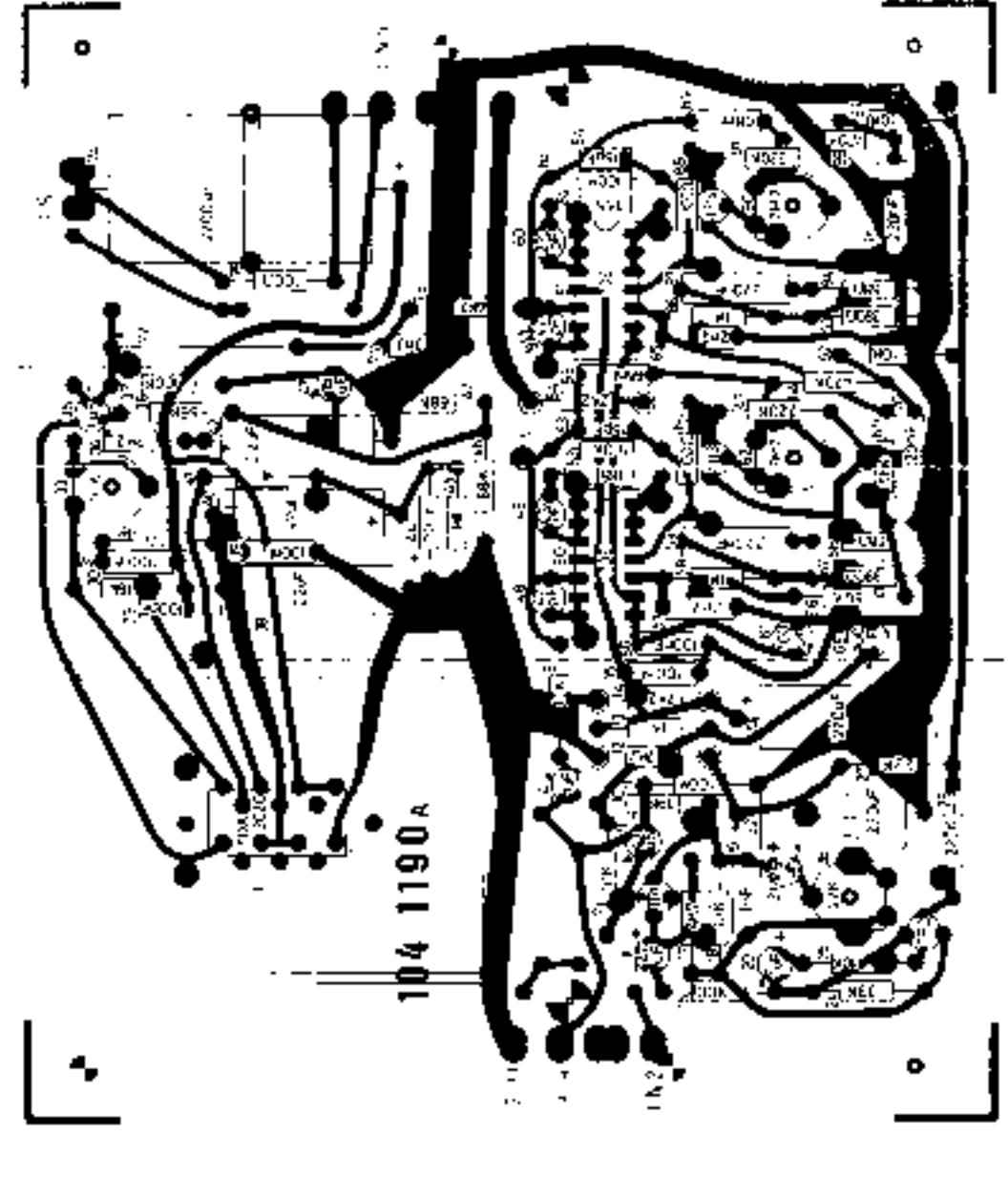

ORBITONE AMPLIFIER CIRCUIT
PART NO. 004 010A

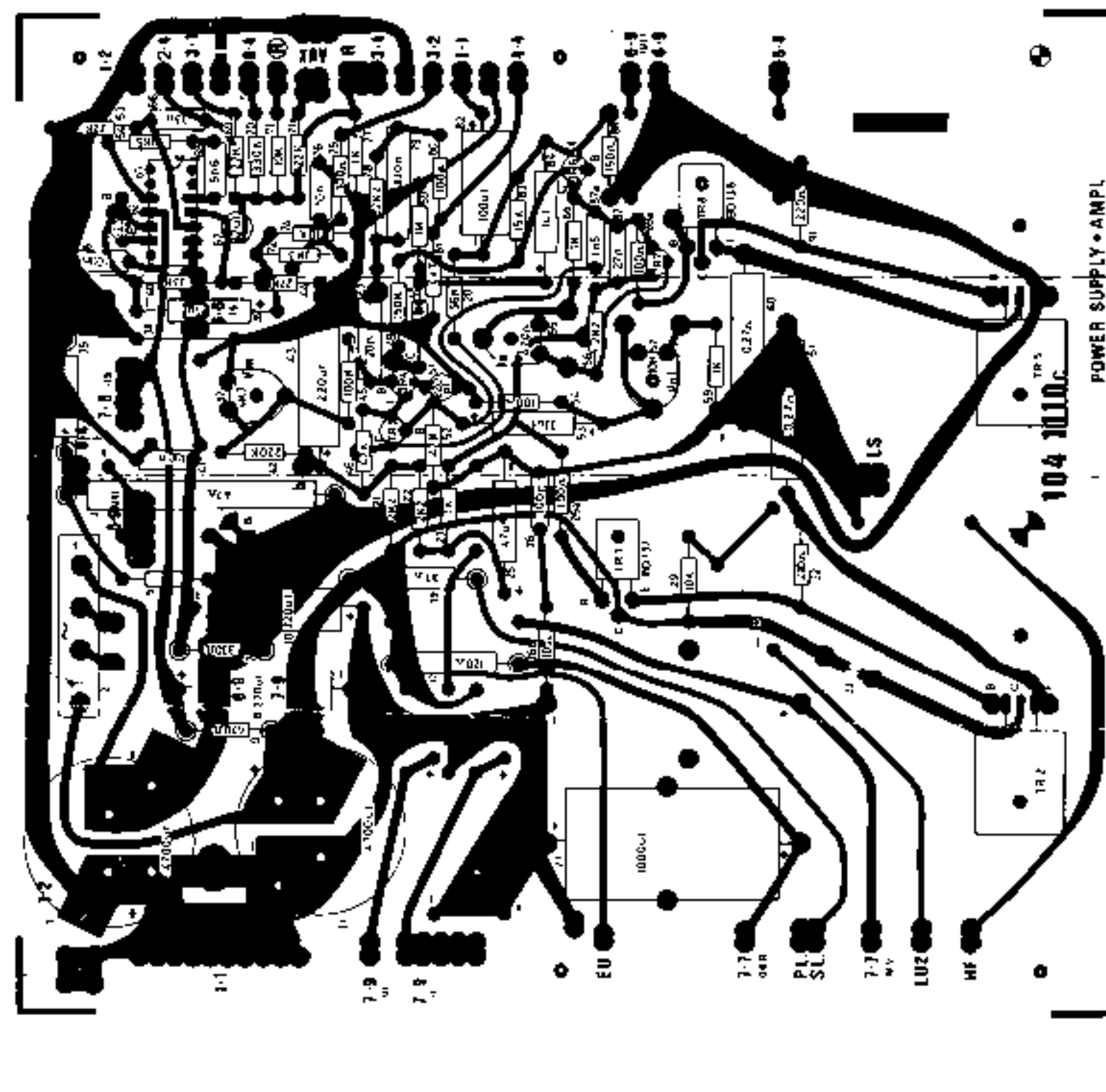

AMPLIFIER 50W
PART NO. 004 0101

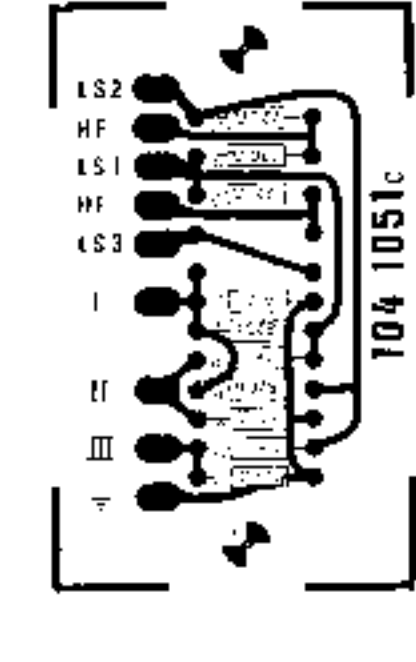

HEADPHONES CIRCUIT
PART NO. 004 010D