

Bu.3 u. Bu.4 für Mikrofonanschluß.

Buchsen und Stecker von außen gesehen. (A-W-Rel.-Kontakte in Wertung Stellung)

1958	Datum	Name
Gezeichnet	9.8.	W. Wassmann
Geprüft		
Normgepr.		
Meßstab		

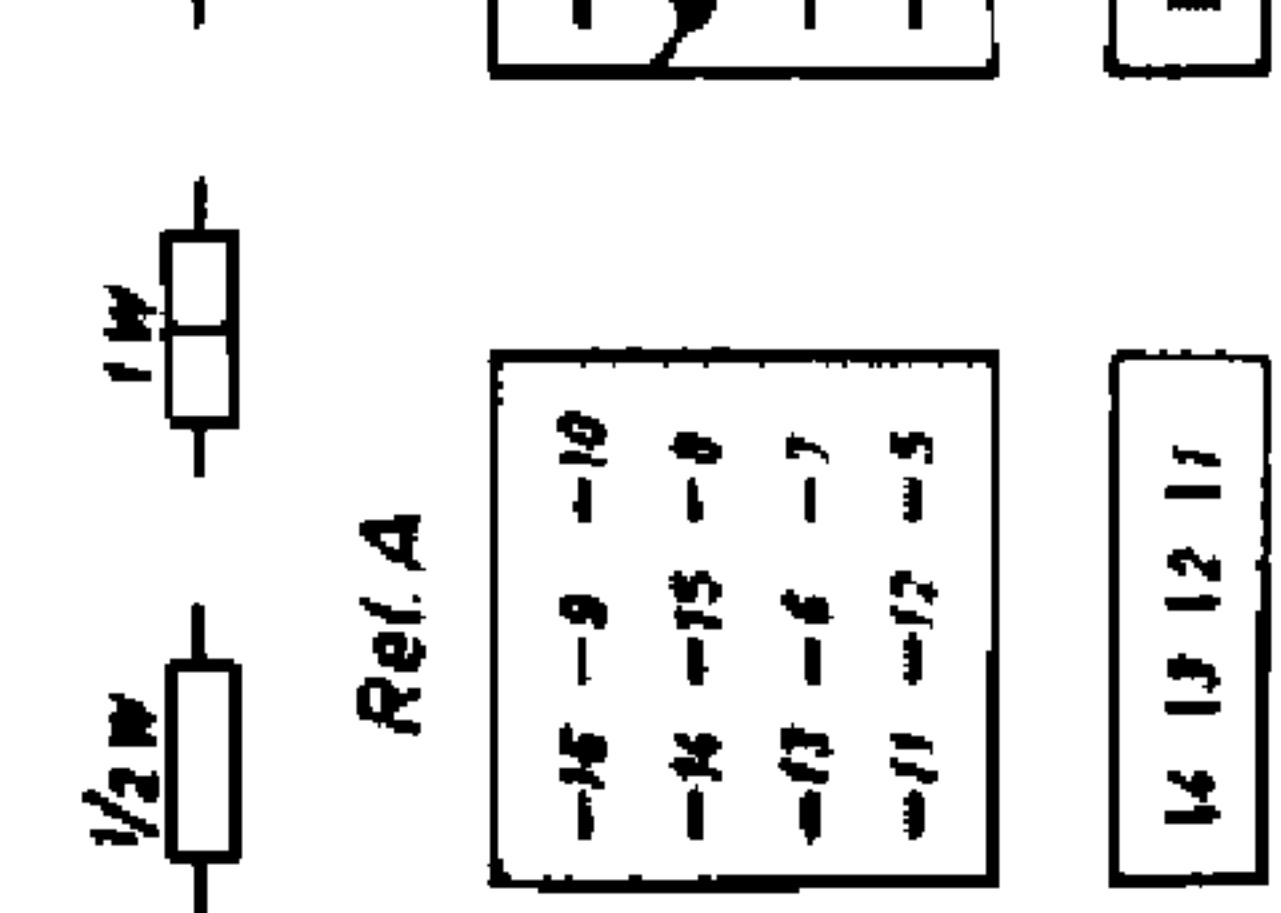
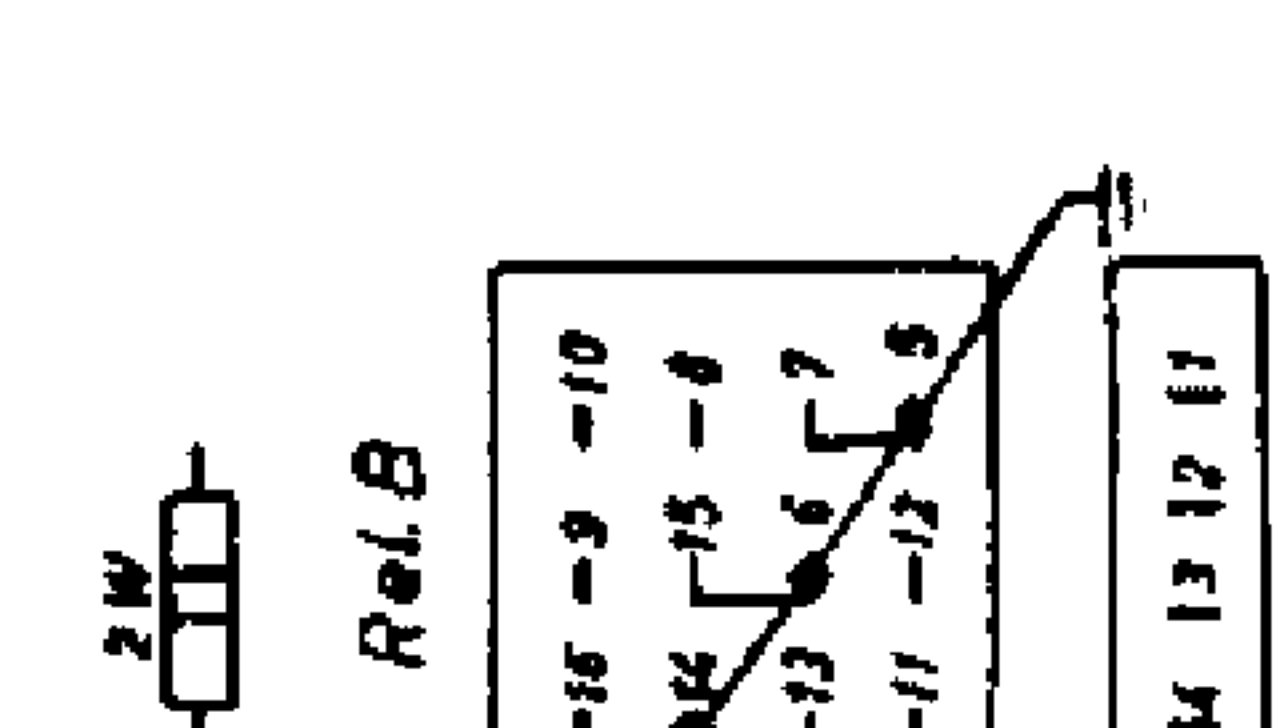
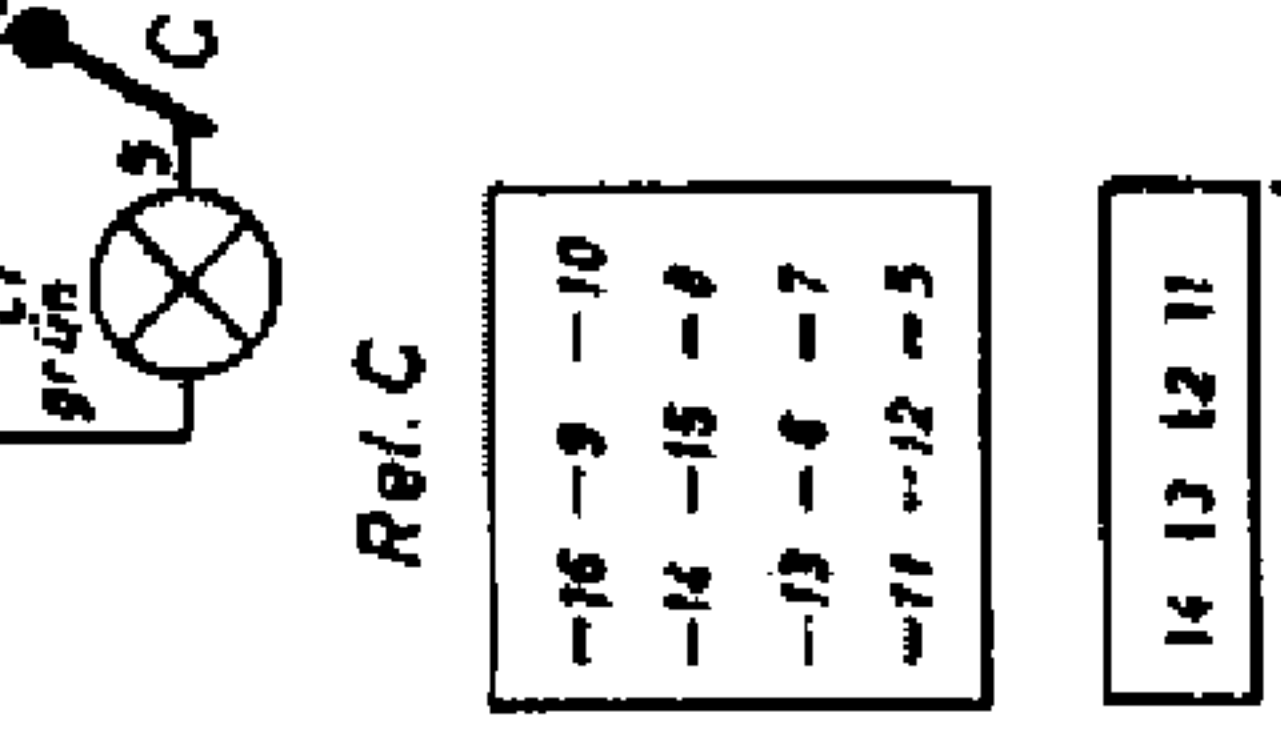
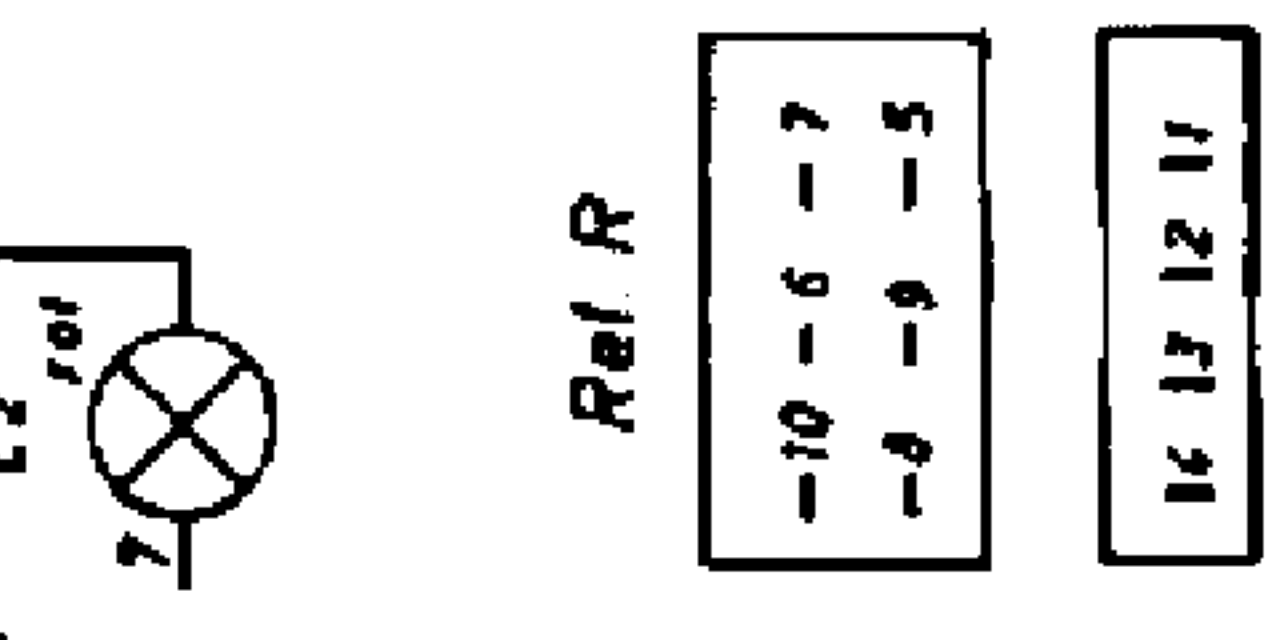
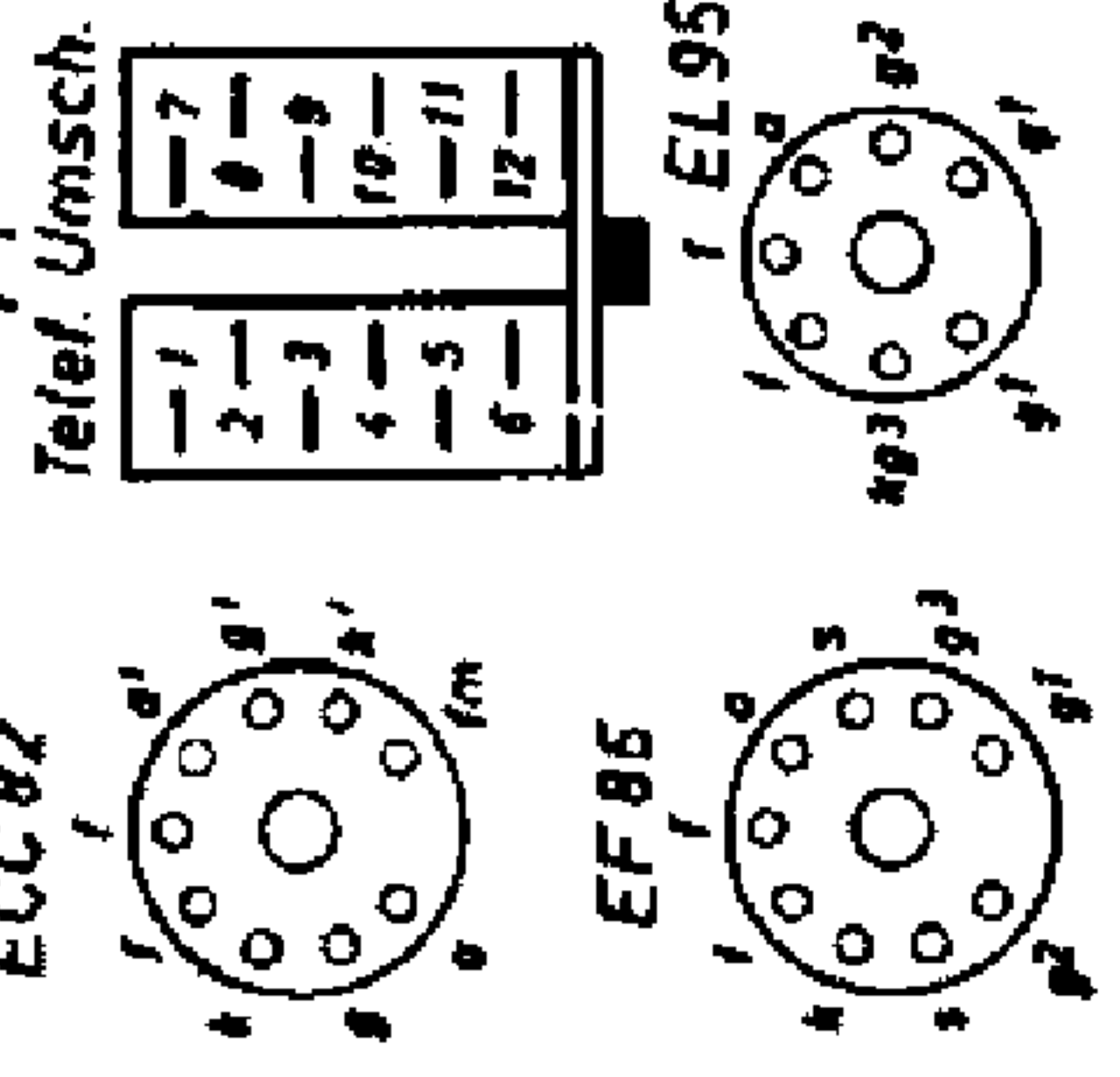

Ned. Ver. v. Historie v/d Radio

ARCHIEF DOCUMENTATIEDIENST NVHR

W. ASSMANN GMBH

0101-50 S I
E. 5012 für 0101-50 S

ASSMANN - UNIVERSA

ab Gerdt Nr. 5011633

zu Zeichnung 0101-50 St, ASSMANN -UNIVERSA.

Änderungen gegenüber -50 Se. Mikrofon zusätzlich bedämpft.

Telefonanschl. mit Postanschlußglied T 07

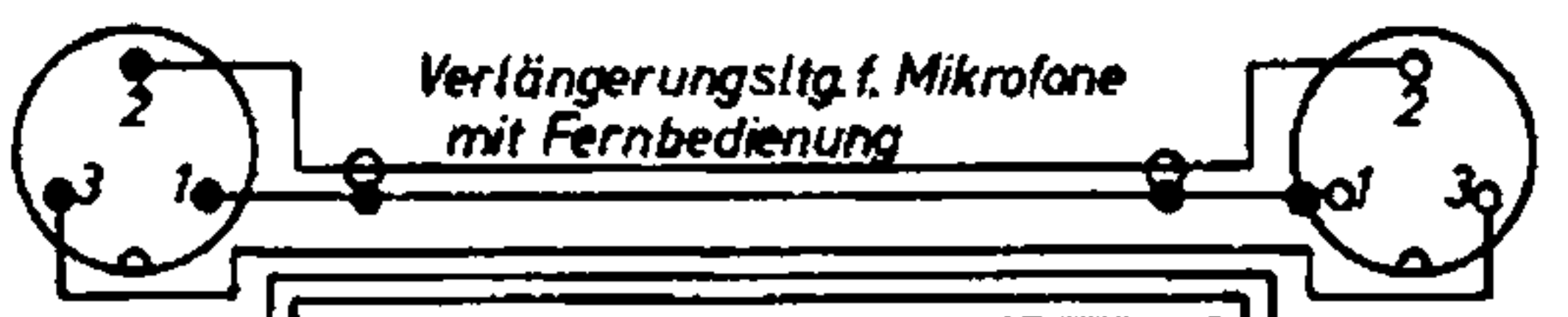
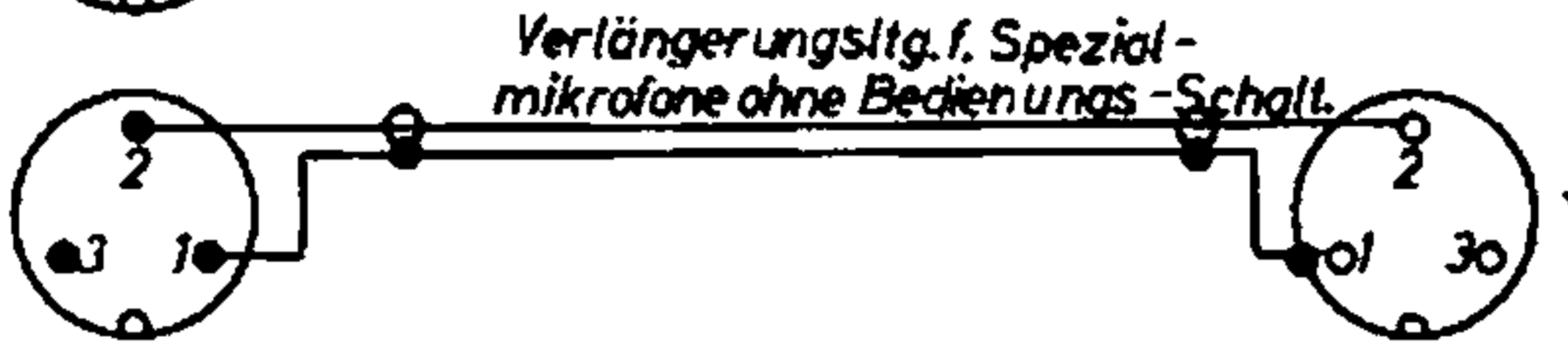
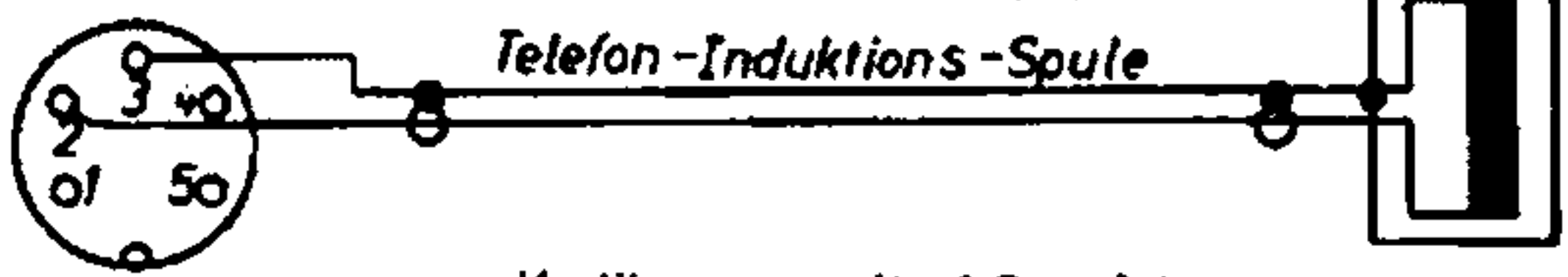
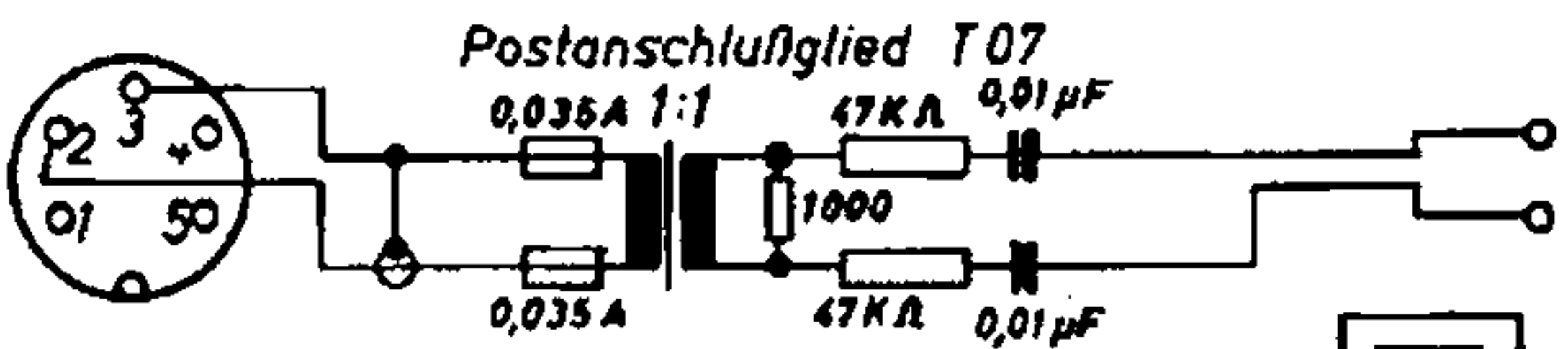
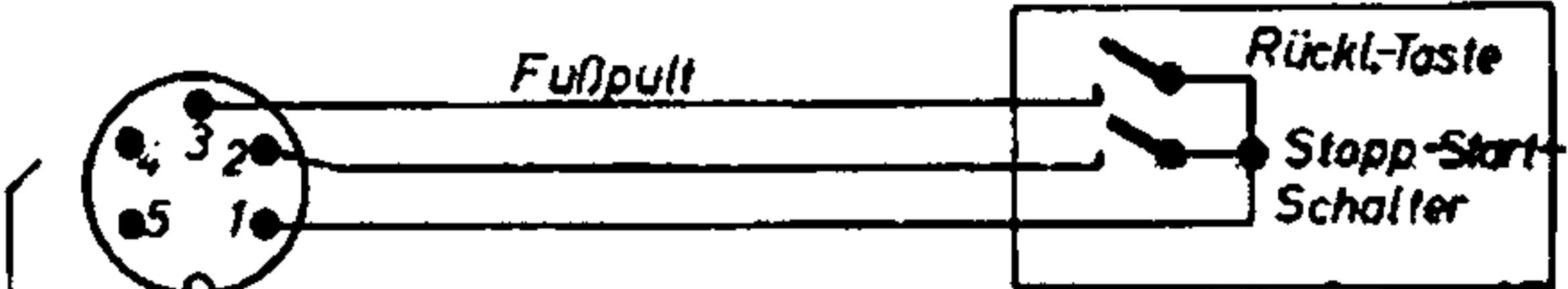
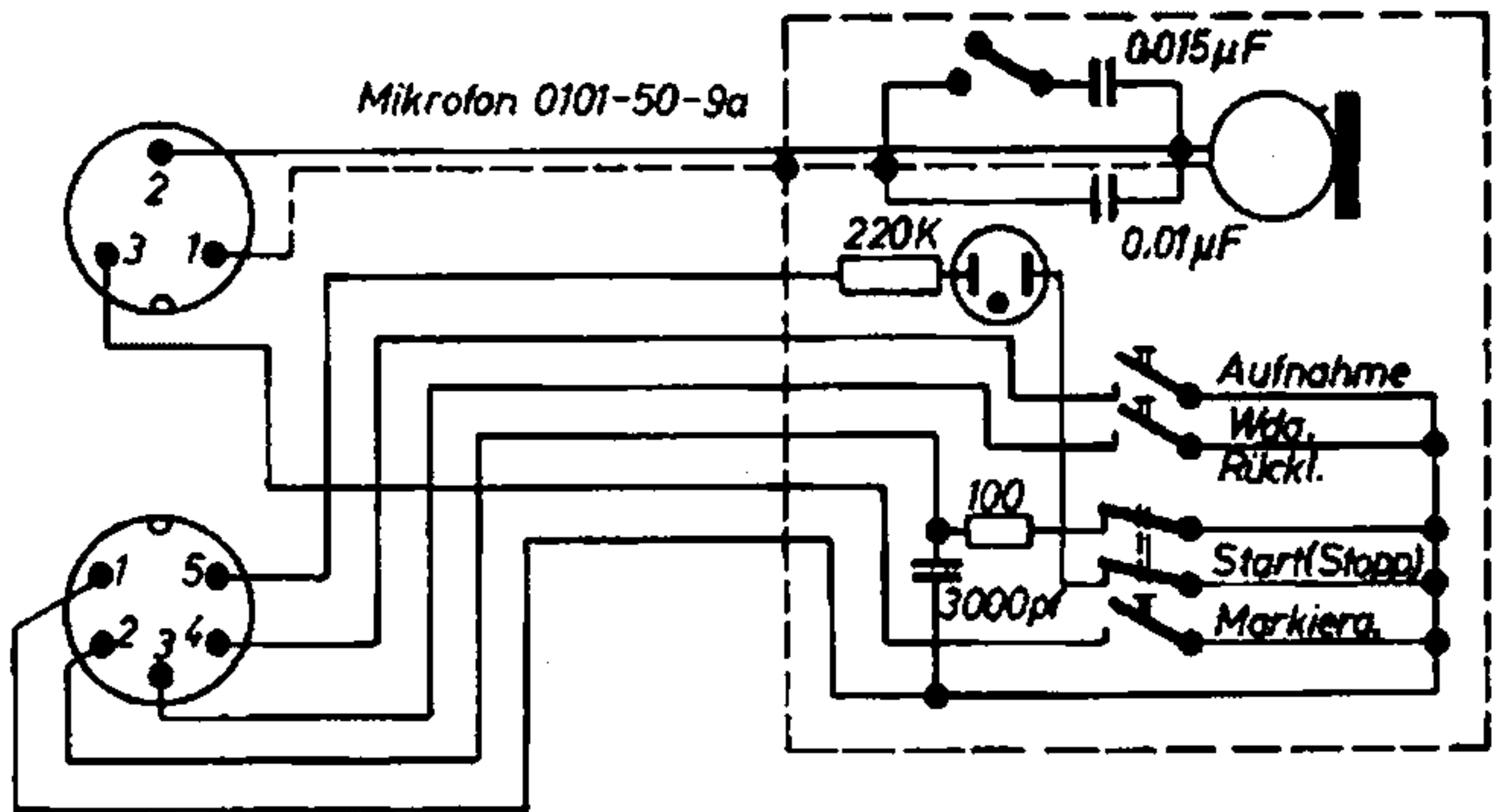

Stecker-
Teile

Buchsentteile

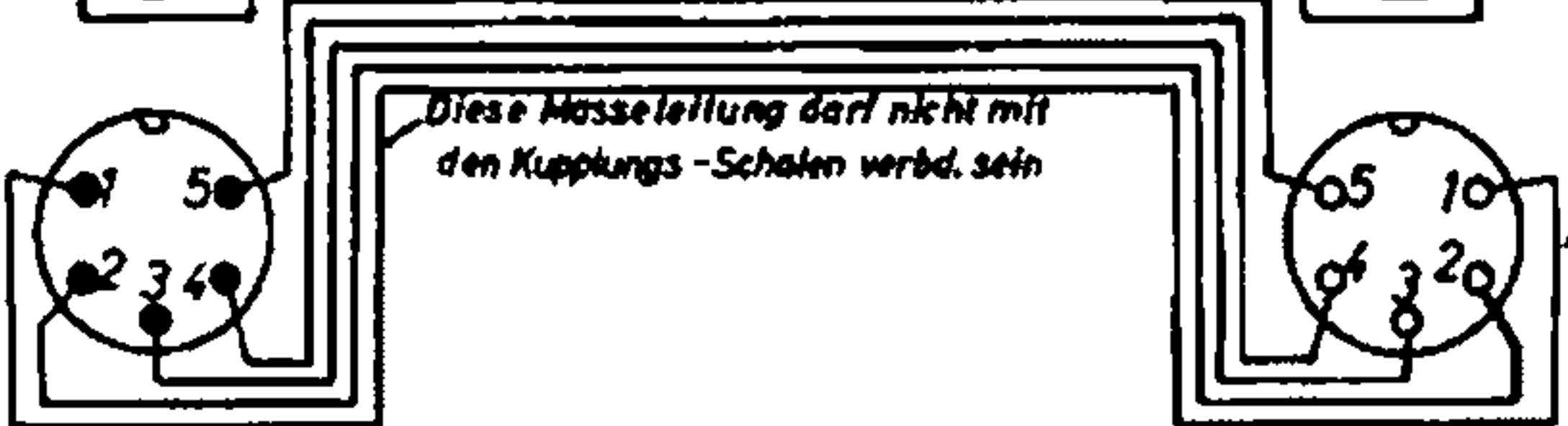

Alle Buchsen- u. Steckeranschl. v. außen gesehen!