

SERVICE NOTES

Ned. Ver. v. Historie v/d Radio

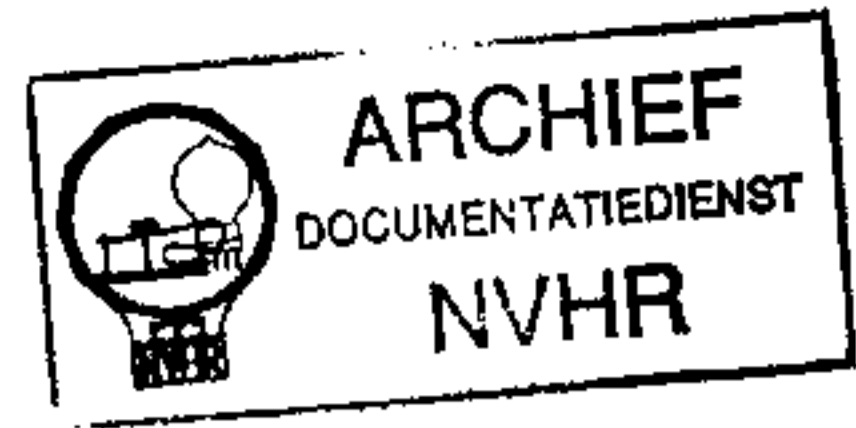

RECORDERS

6127/05G

6127-05G is identical to the 6127-05 except the connection for the stereo pre-amplifier EL 3774 and the track parallel switch which have been introduced in the 6127-05G.
For the deviating service parts, see the list given below.

De 6127-05G is gelijk aan de 6127-05 behalve de aansluiting voor de stereo-voorversterker EL 3774 en de sporen-schakelaar SK11 die in de 6127-05 zijn ingevoerd.
Voor afwijkende service-onderdelen, zie onderstaande stuklijst.

Der 6127-05G ist gleich dem 6127-05, mit Ausnahme des Anschlusses für den Stereo-Vorverstärker EL 3774 und des Spulenparallelschalters, welche in 6127-05G eingeführt worden sind.
Für die abweichenden Ersatzteile siehe untenstehende Stückliste.

Le 6127-05G est identique au 6127-05, excepté la connexion pour le pré-amplificateur EL 3774 et pour le commutateur de piste en parallèle qui ont été introduits dans le 6127-05G.
Pour les pièces de rechange qui diffèrent, voir la liste de pièces ci-dessous.

El 6127-05G es idéntico al 6127-05, excepto la conexión para el preamplificador estereo EL 3774 y el conmutador de pista en paralelo que han sido introducidos en el 6127-05G.
Para repuestos, cuyos números desvían de los normales, véase la lista de componentes a continuación.

Switch SK11	WY 837 91	Schakelaar SK11	Schalter SK11	Commutateur SK11	WY 837 91	Conmutador SK11
R59	B8 305 08B/47K	R59	R59	R59	B8 305 08B/47K	R59
R60	900/6K8	R60	R60	R60	900/6K8	R60
Knob	WT 262 38	Knop	Knopf	Bouton	WT 262 38	Botón
Bushing	WT 910 59	Geleiding voor knop	Duchse für Knopf	Manchon pour bouton	WT 910 59	Manguito para botón

SERVICE INFORMATION										
---------------------	--	--	--	--	--	--	--	--	--	--

R	20. 2.	1.	7.	4.	5.	30. 36. 31.	35. 12.	9.	10. 11. 34.	57. 13. 14. 15. 16. 17. 54.	19.	56.	33. 51. 33.		
C		1.	2.		3.	8.		4.	5.	24. 6.	7. 23.	9.	10.	11.	20. 22.

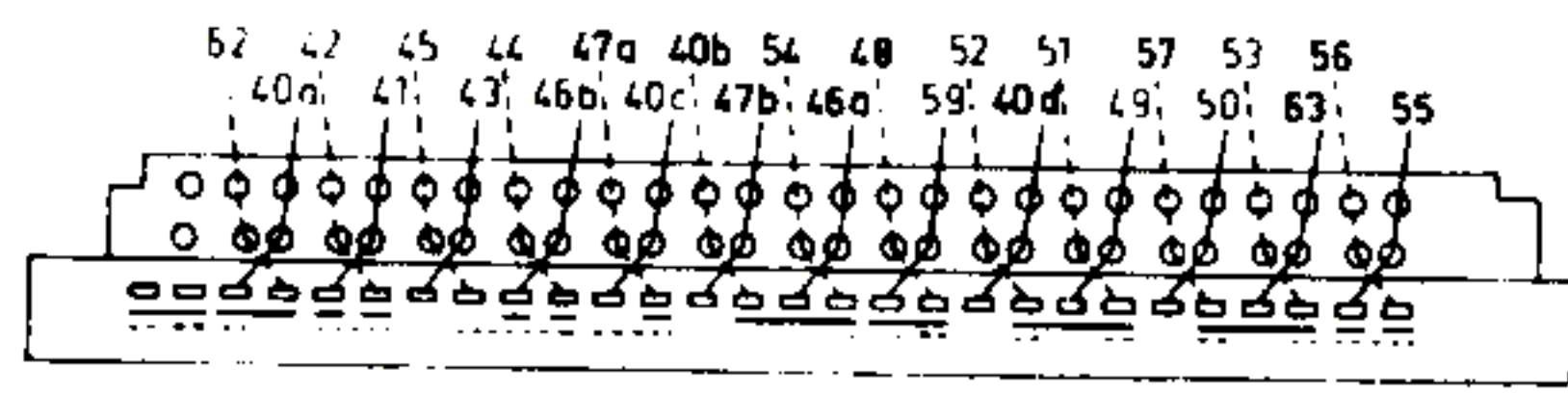
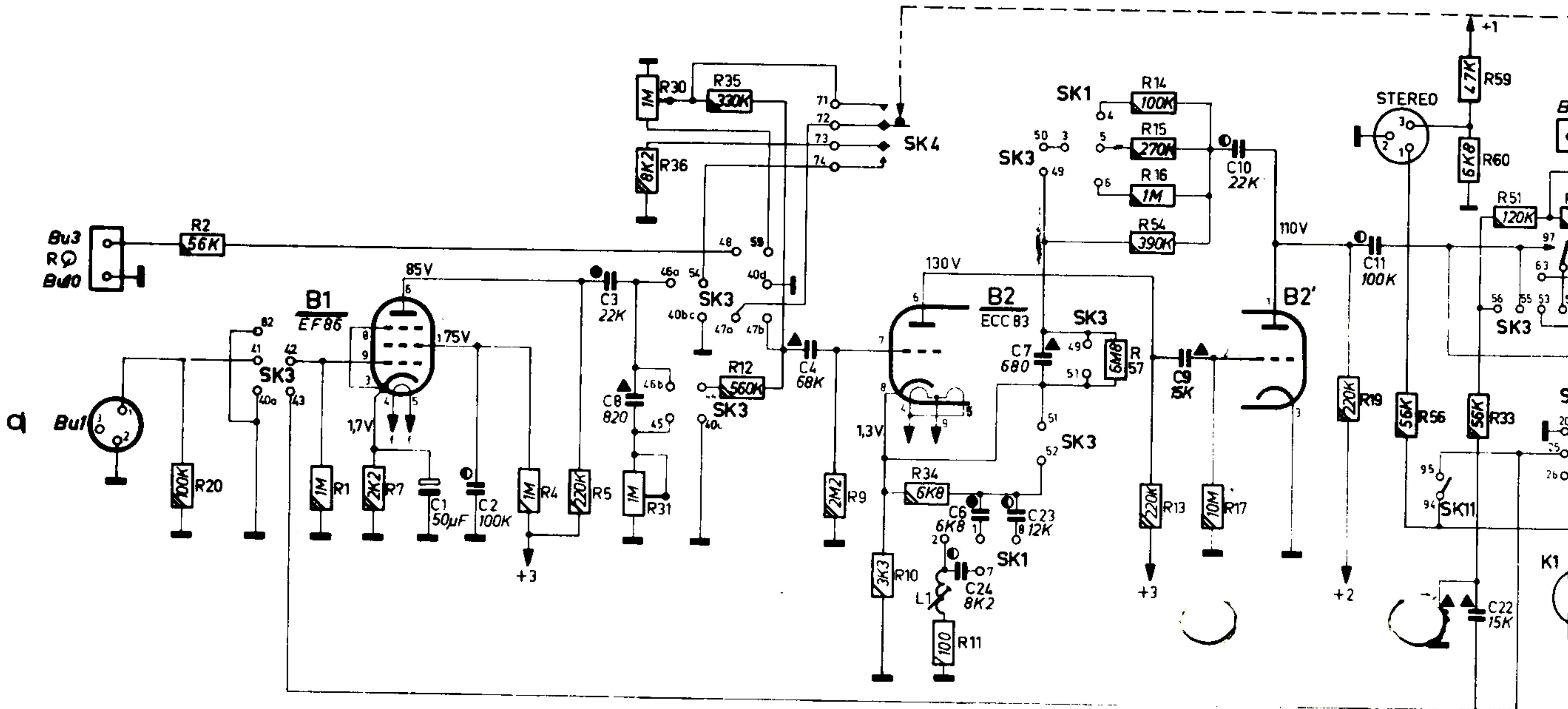

SK3

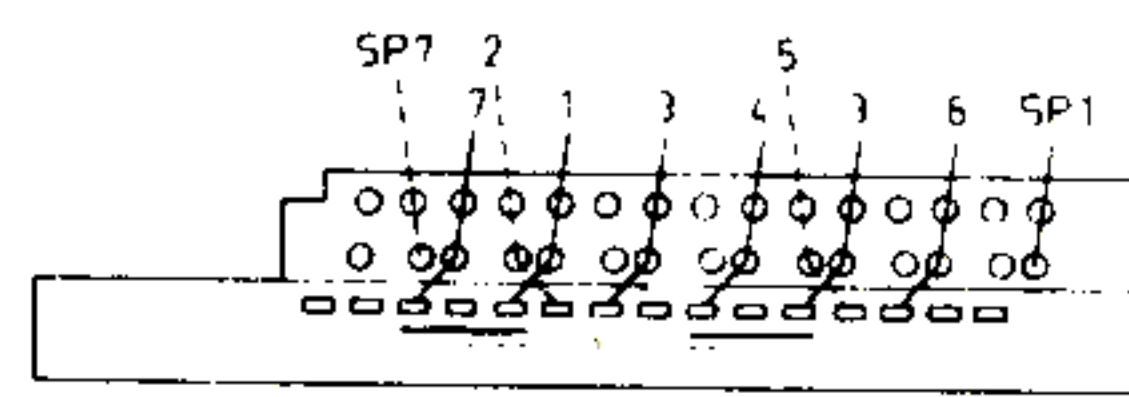

SK1

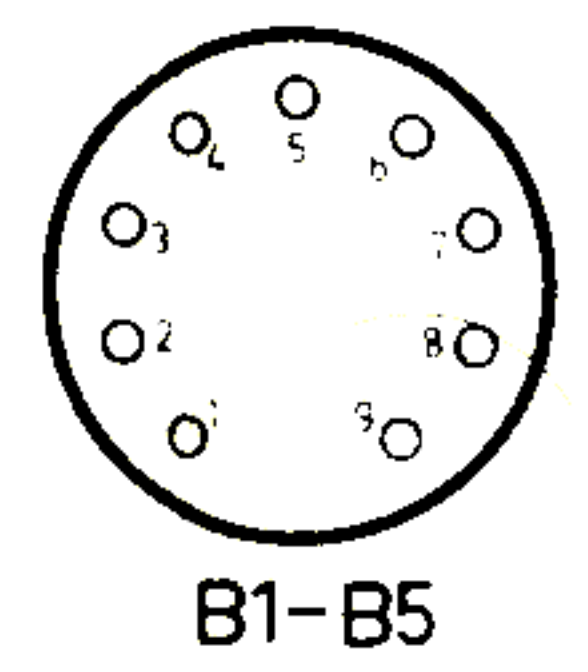

B1-B5

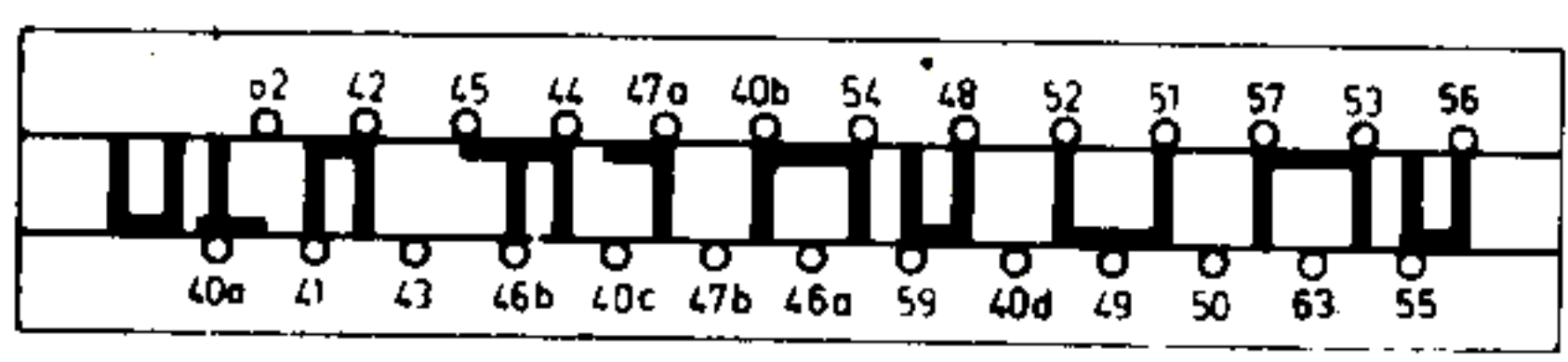

SK3
POSITION:
STOP

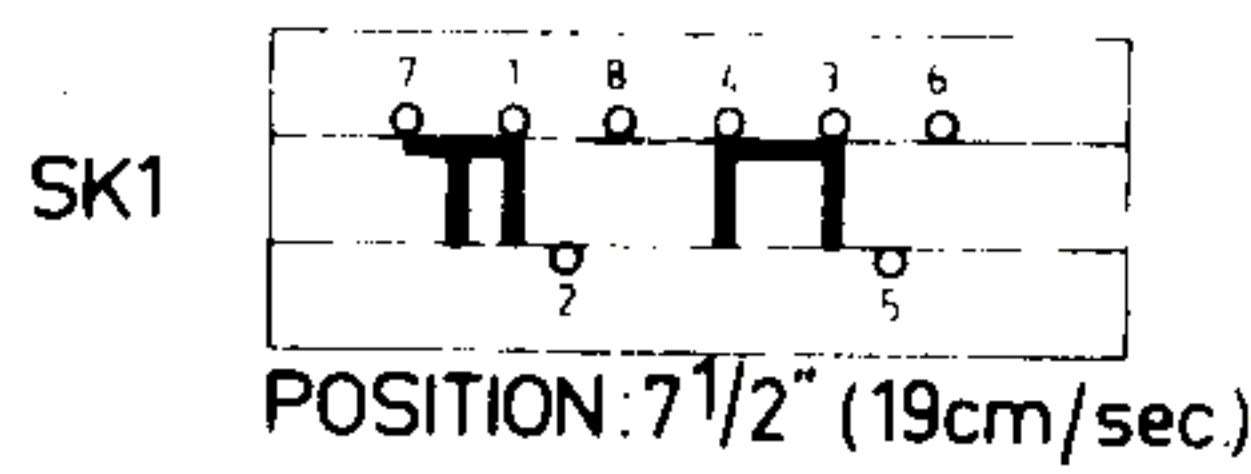

SK1
POSITION: 7 1/2" (19cm/sec)

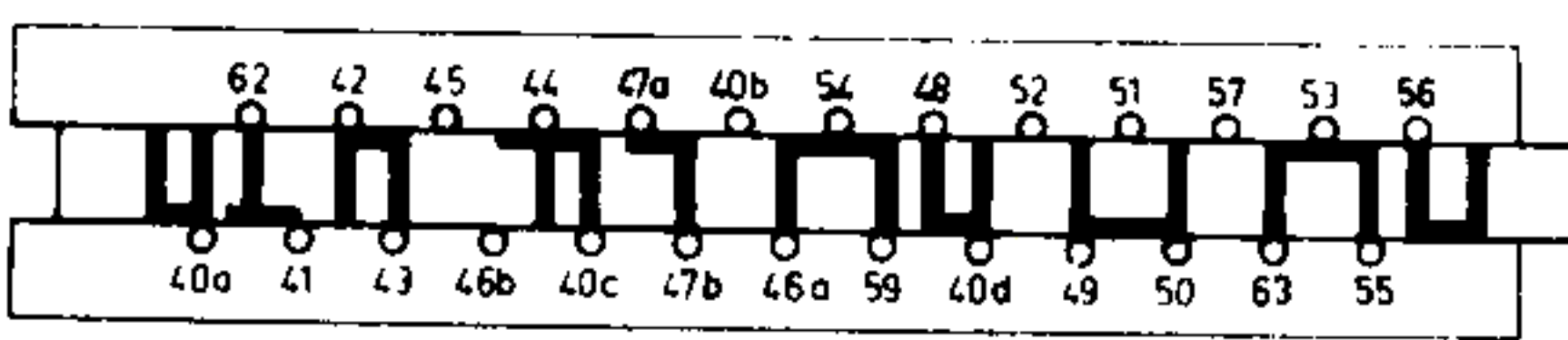
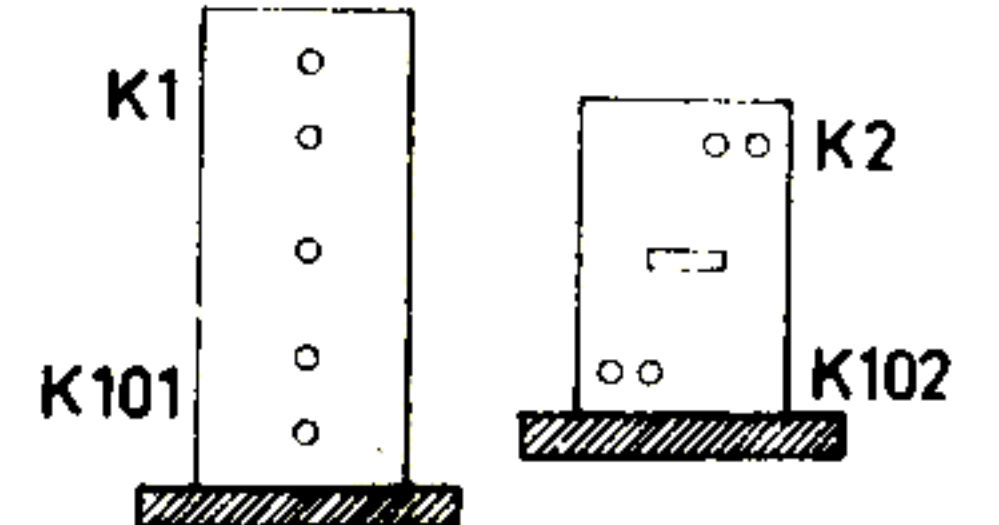

SK3
POSITION:
PLAY BACK

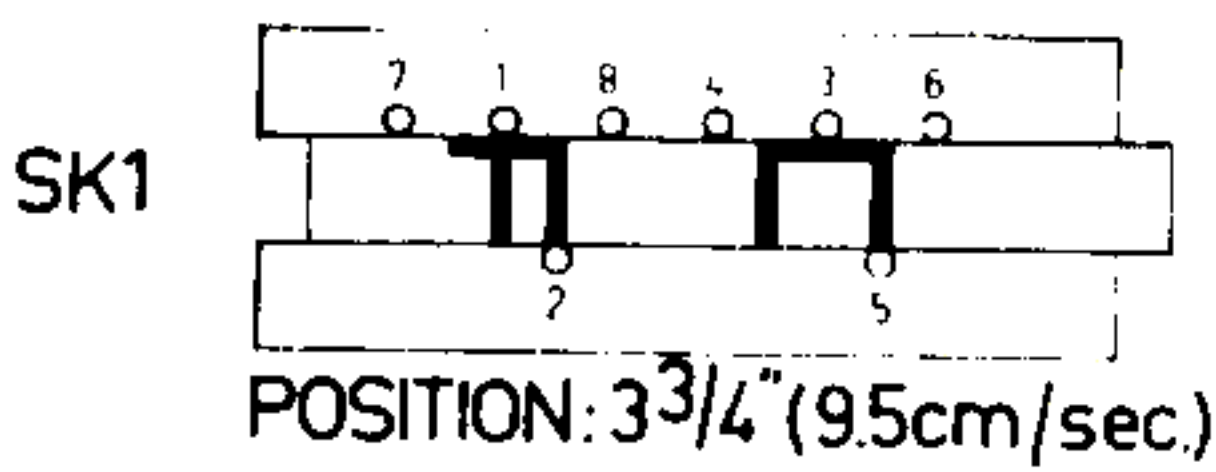

SK1
POSITION: 3 3/4" (9.5cm/sec)

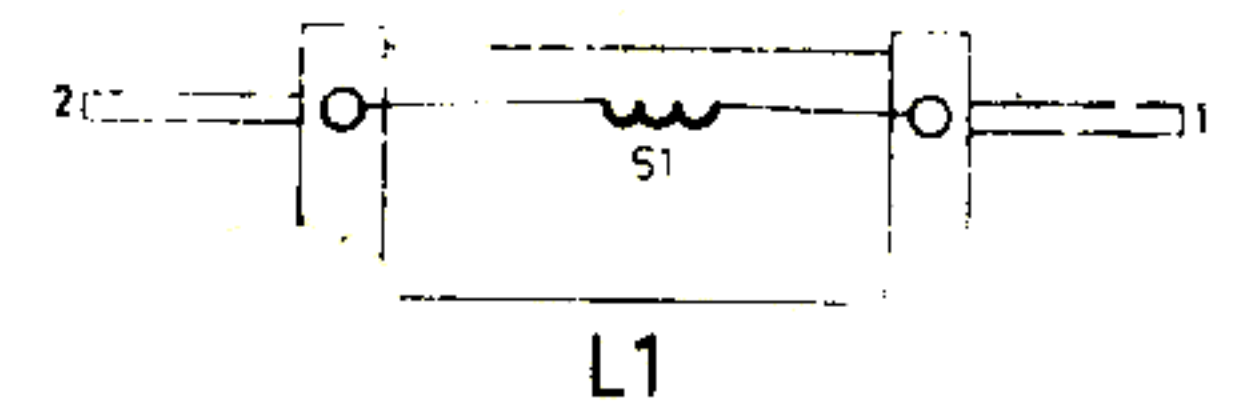

L1

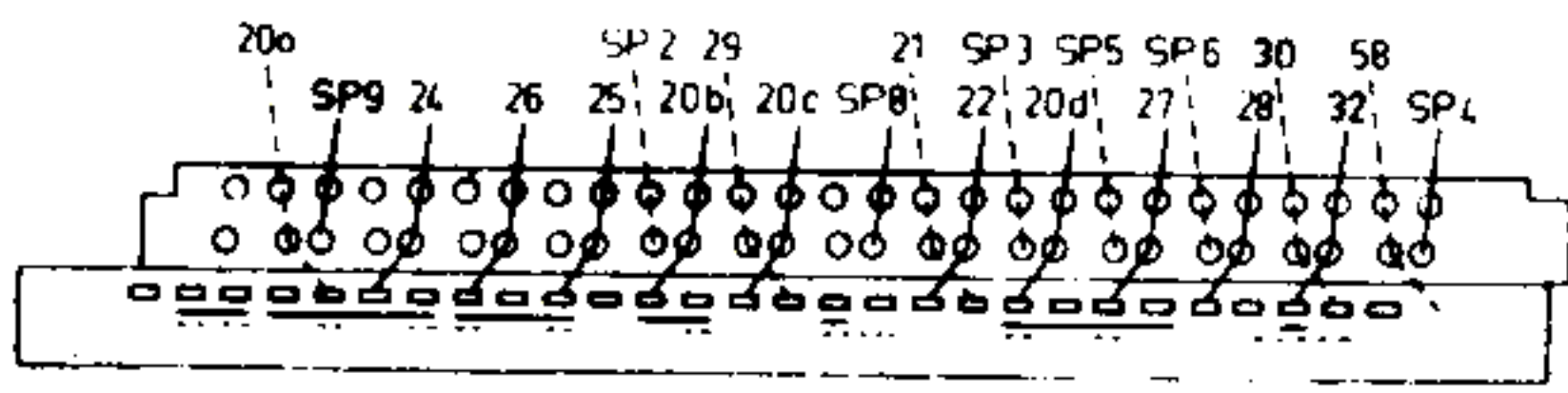

SK2

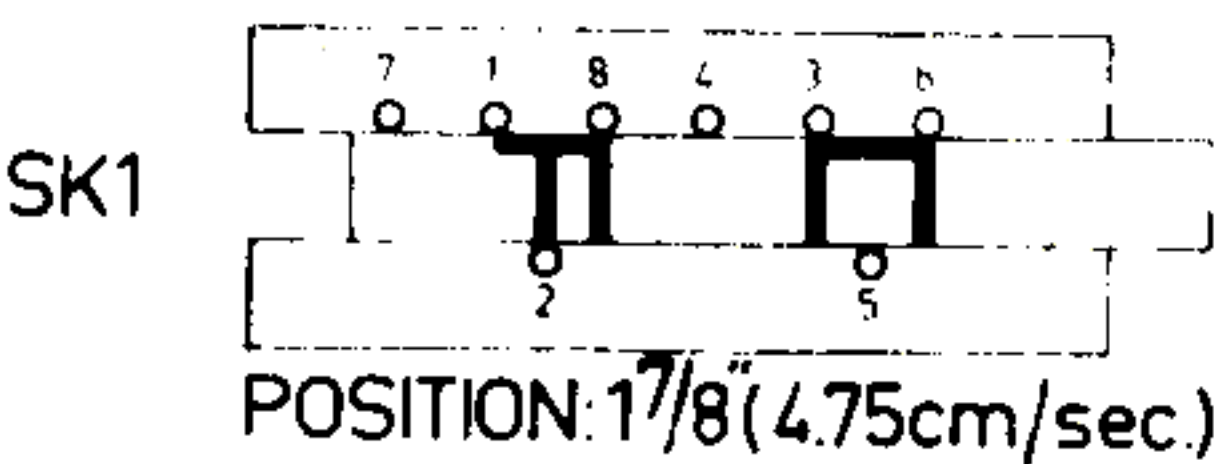

SK1
POSITION: 1 7/8" (4.75cm/sec)

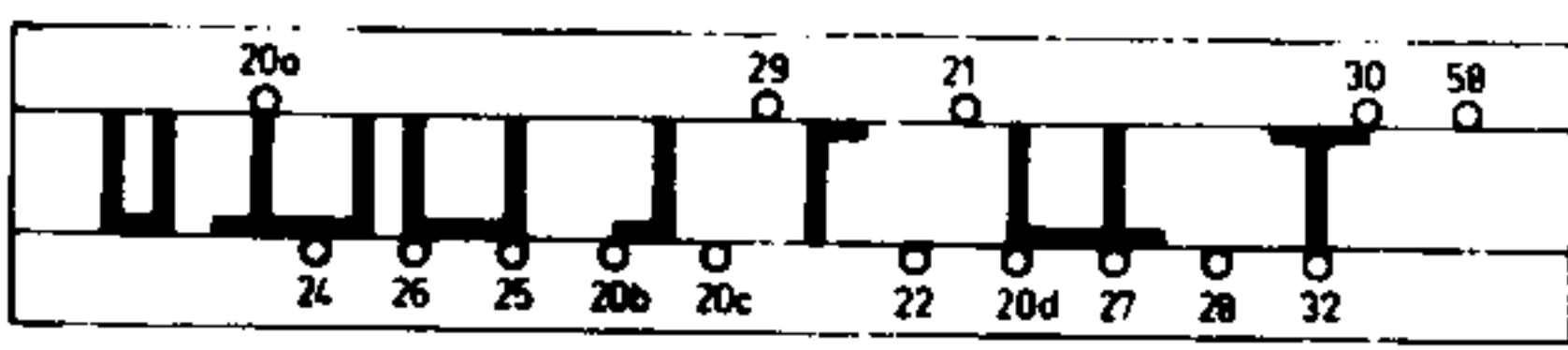
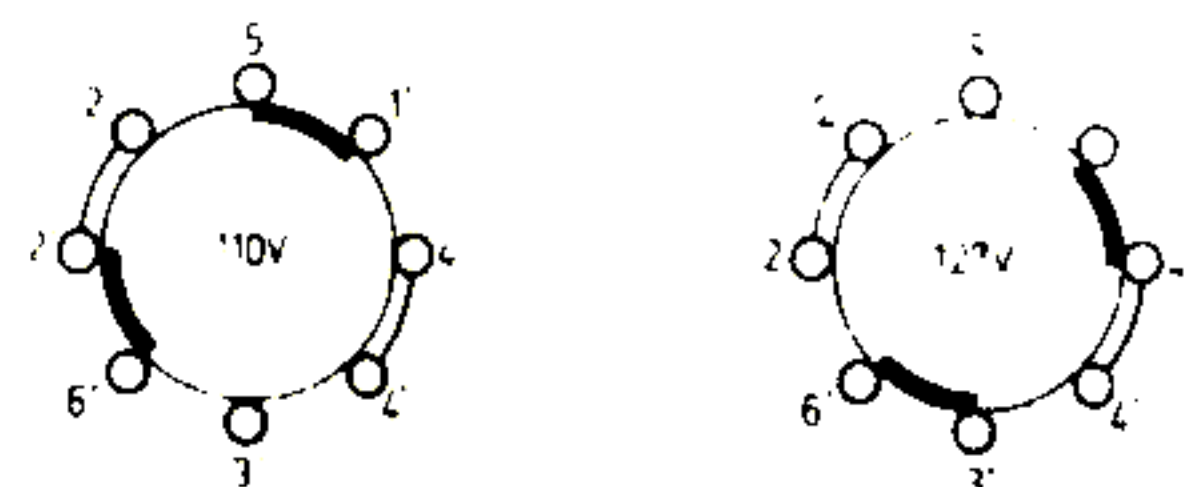

SK2
POSITION:
STOP

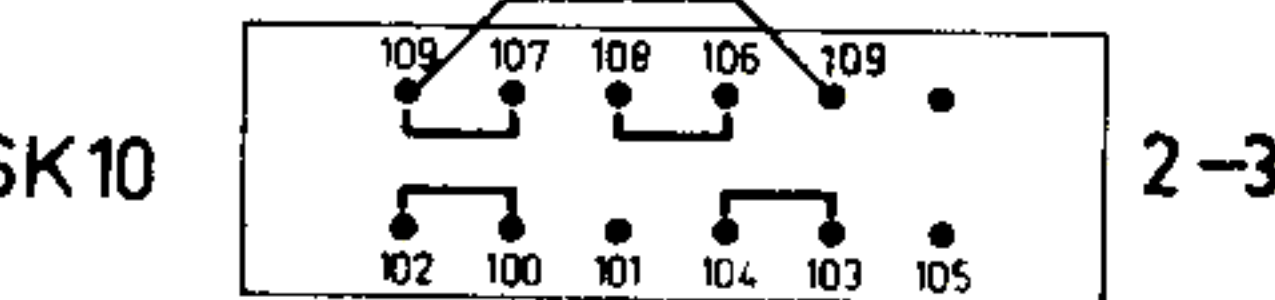

SK10
2-3

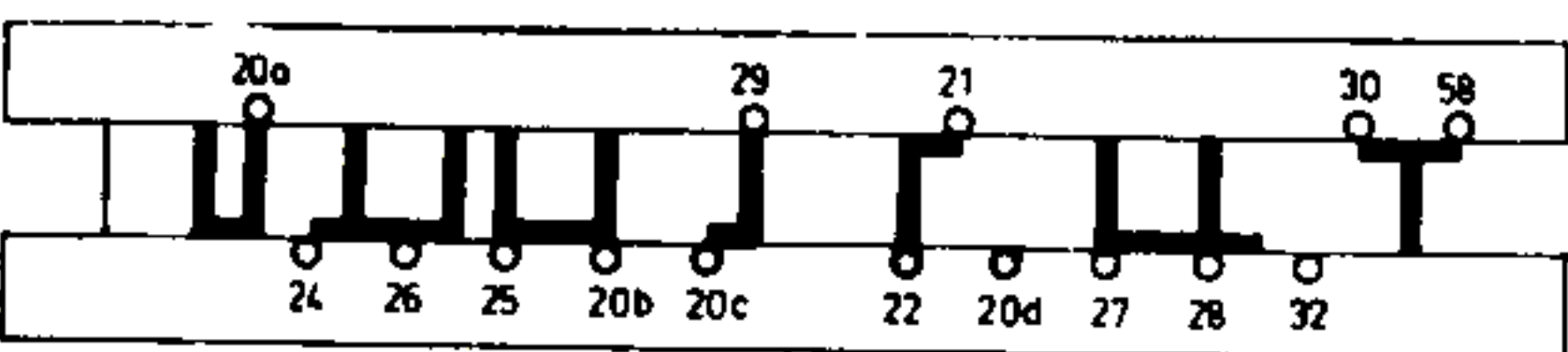

SK2
POSITION:
RECORDING

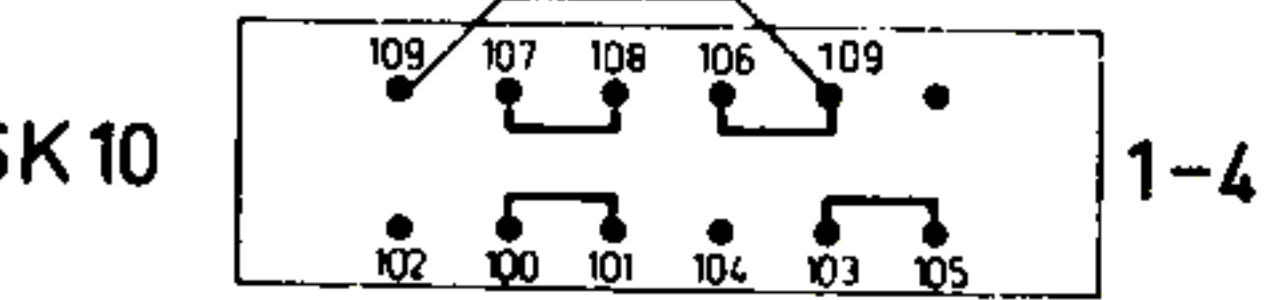

SK10
1-4

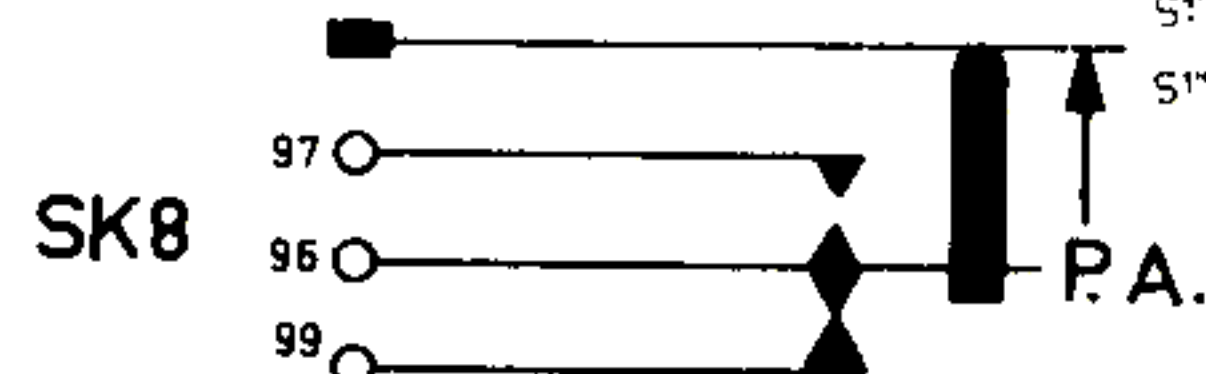
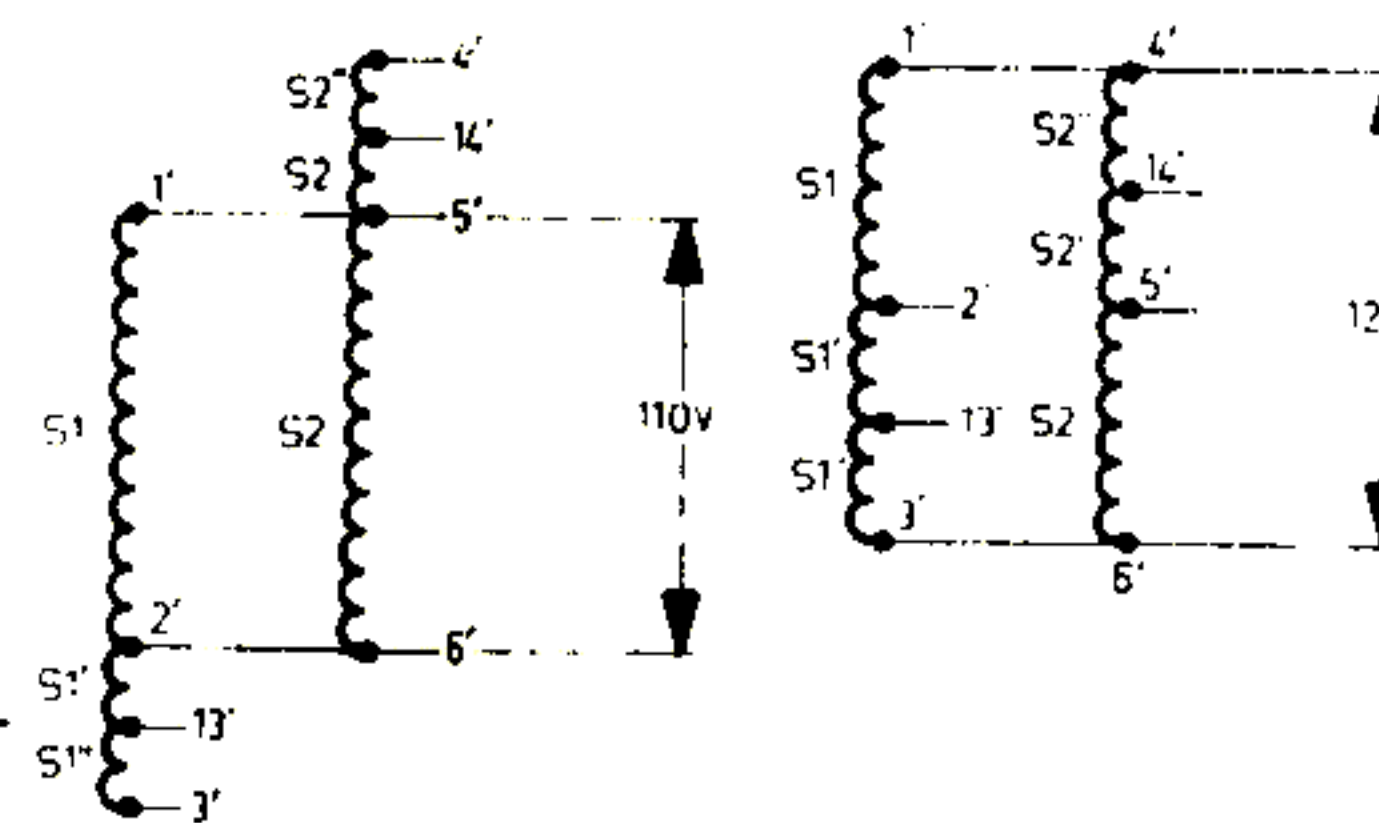

SK8

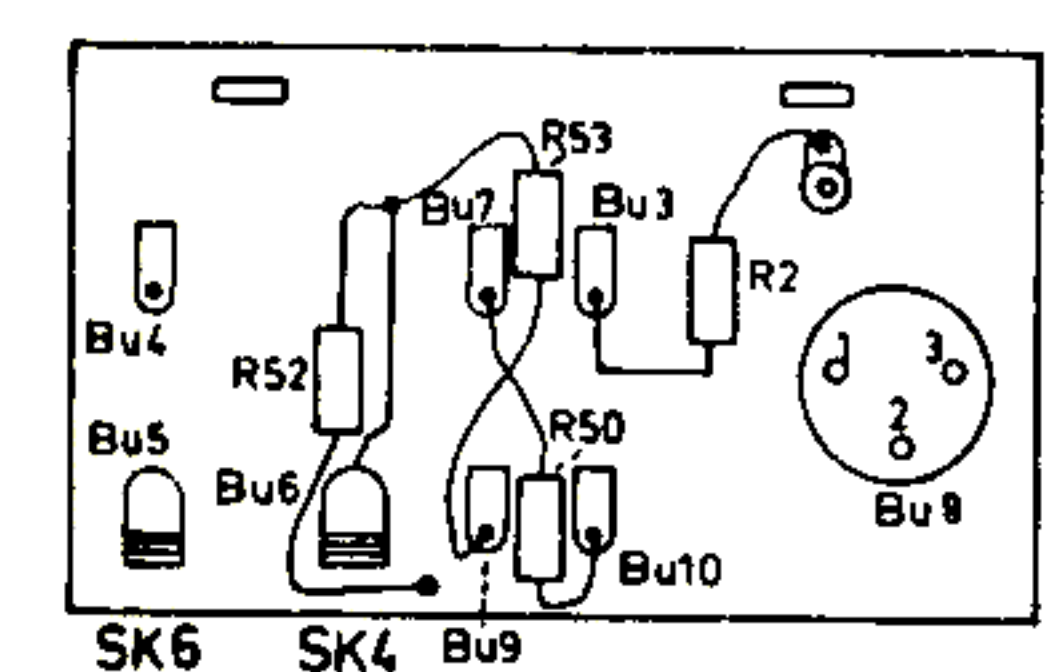

SK6 SK4 Bu9 Bu10 Bu3 Bu4 Bu5 Bu6 Bu7 Bu8 R2 R50 R53

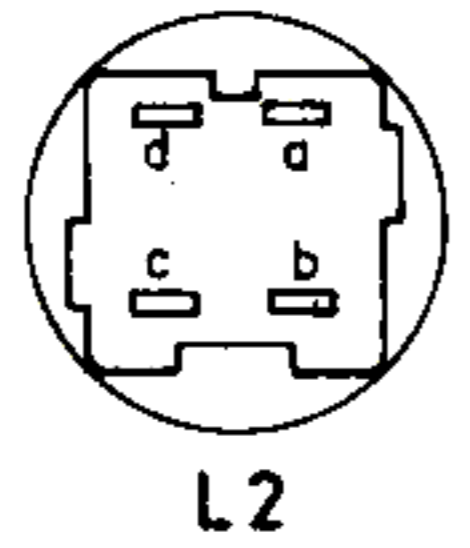
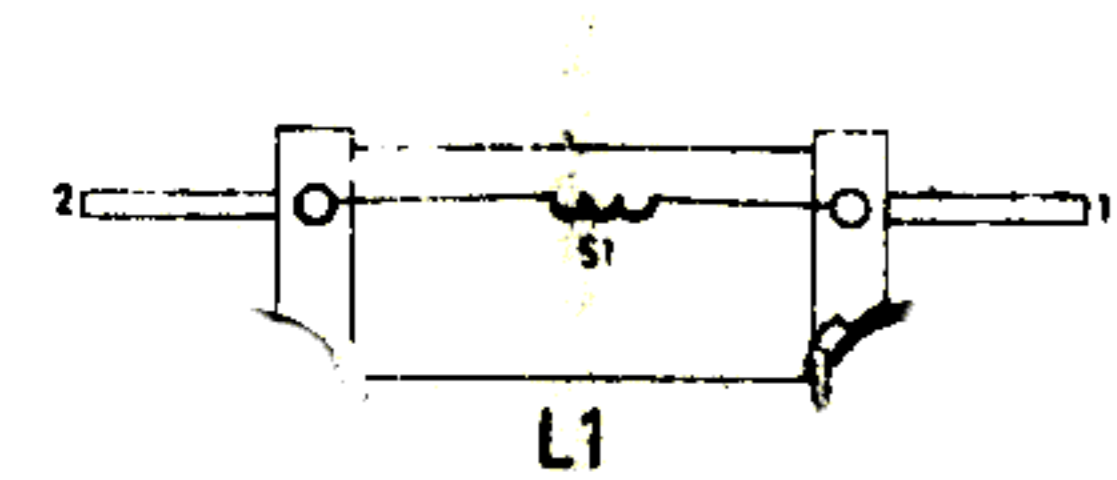
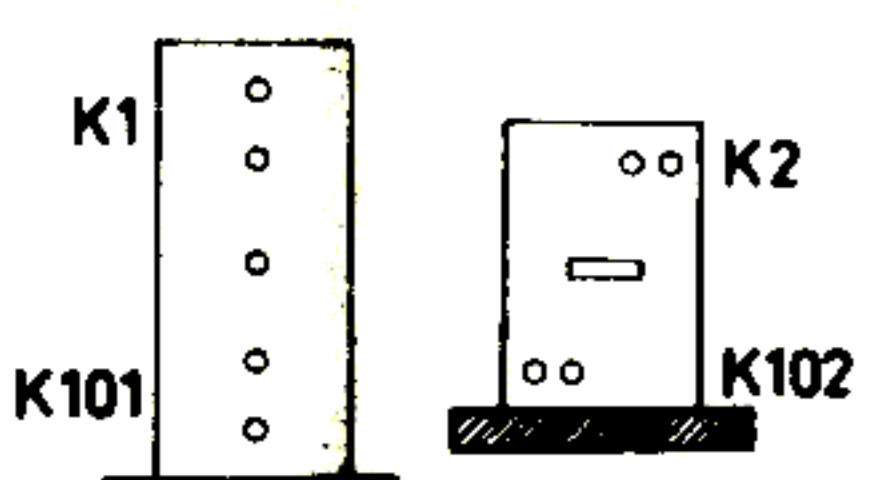
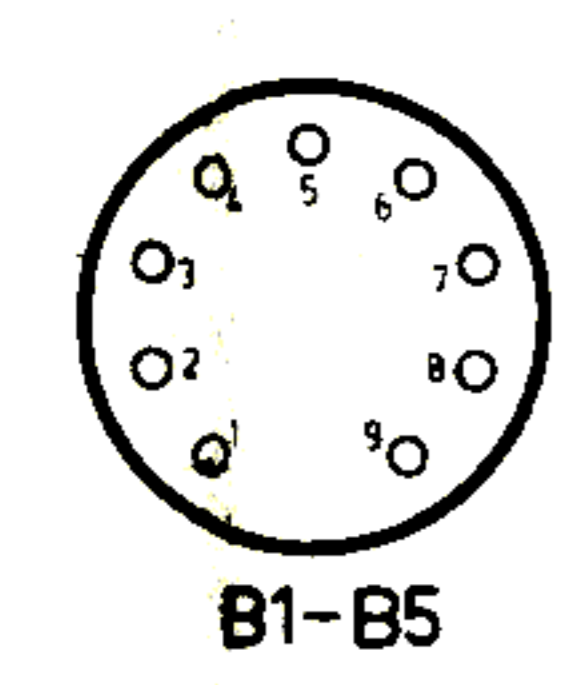
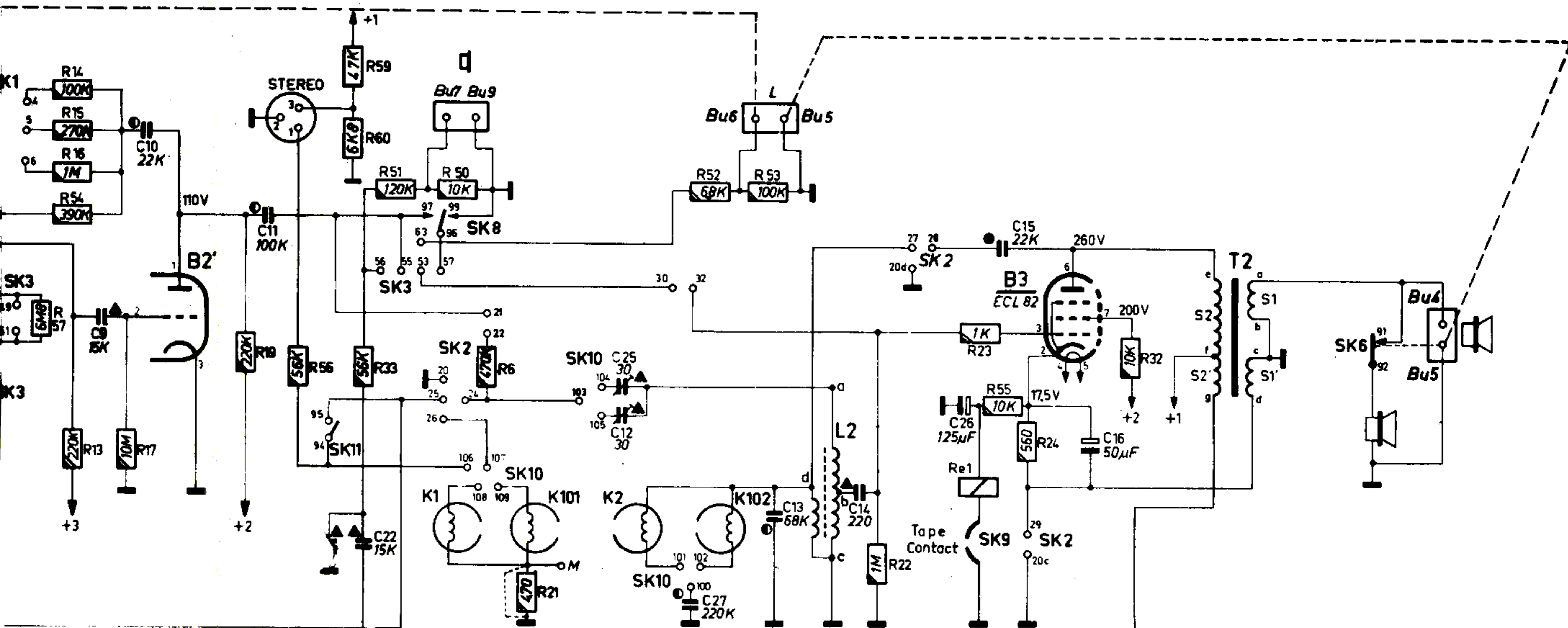

S1	S1'	S1''	S2	S2'	S2''	S3	S3'	S4	S4'	
110	11	33	110	11	33	285	285	375	375	V
						1080		0.27		Ω

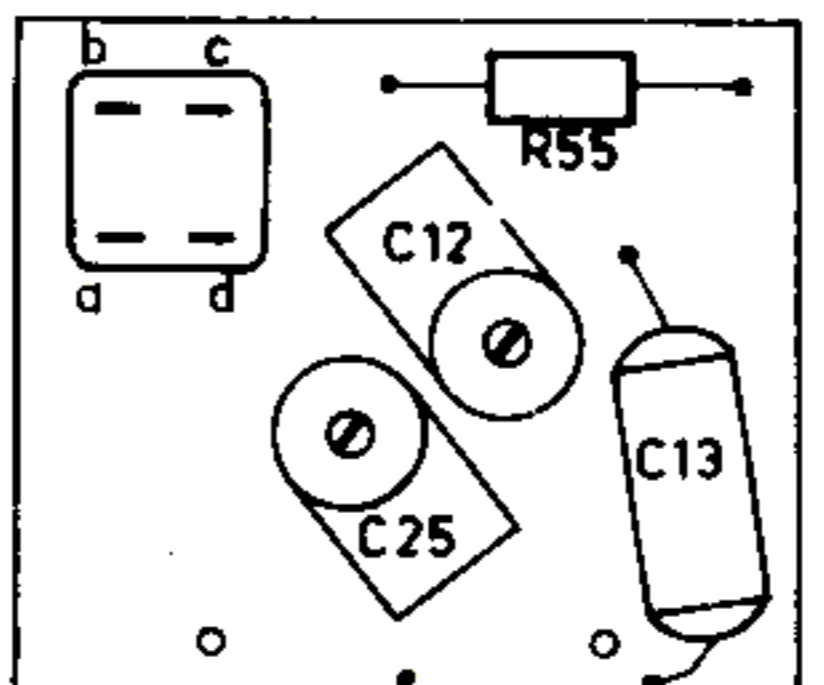
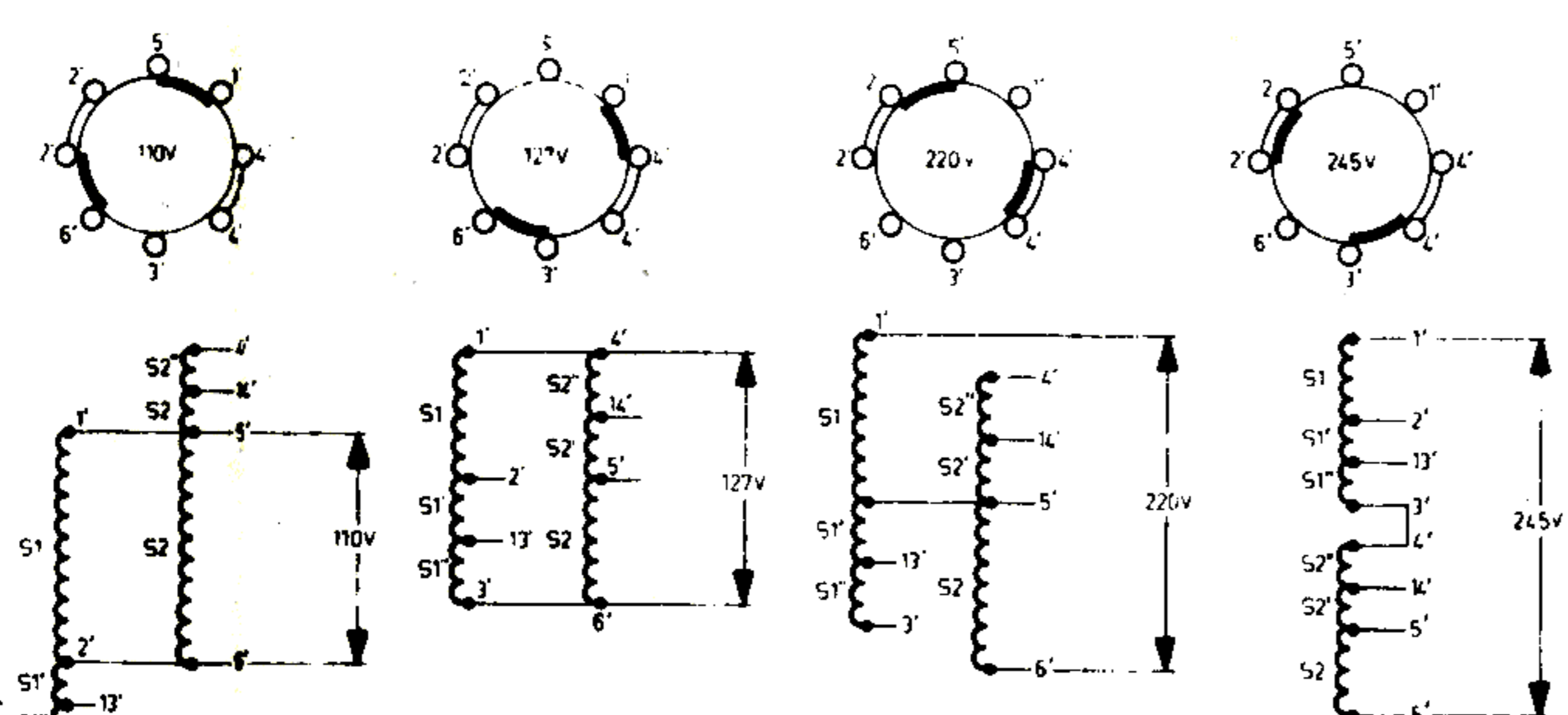
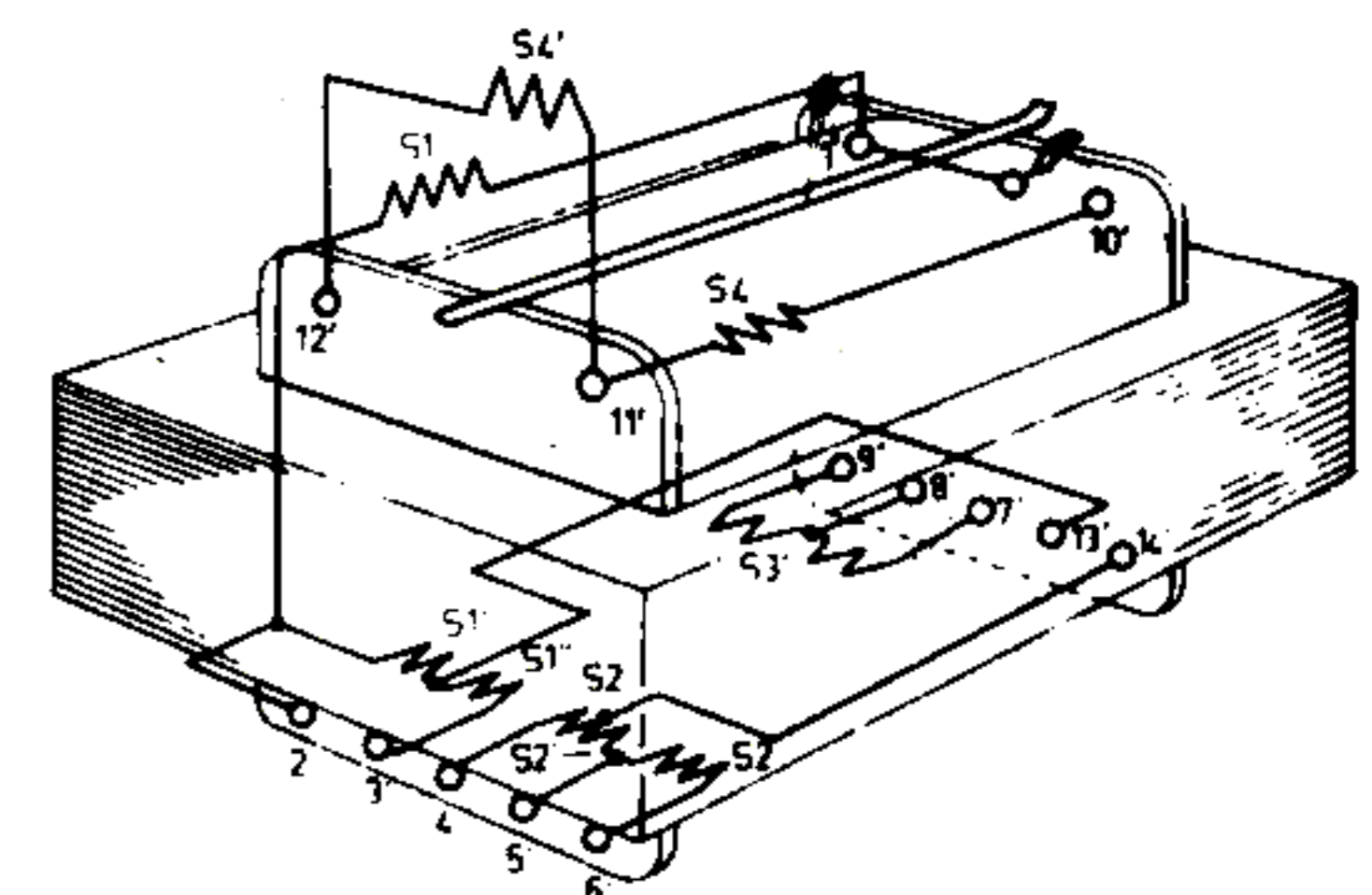

S1	S1	S2	S2	
35	7.6	122	9.3	V
0.62	37.5		773	Ω

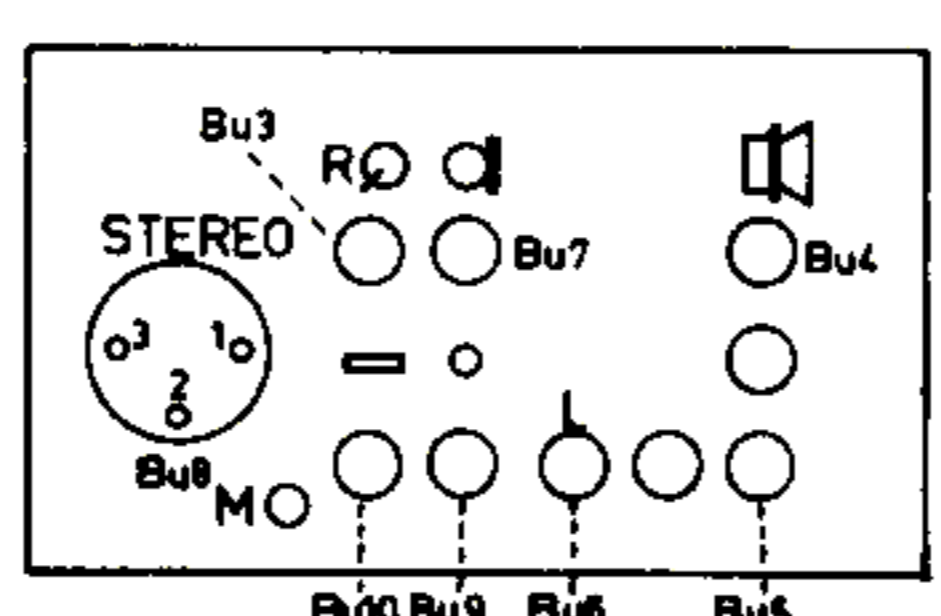
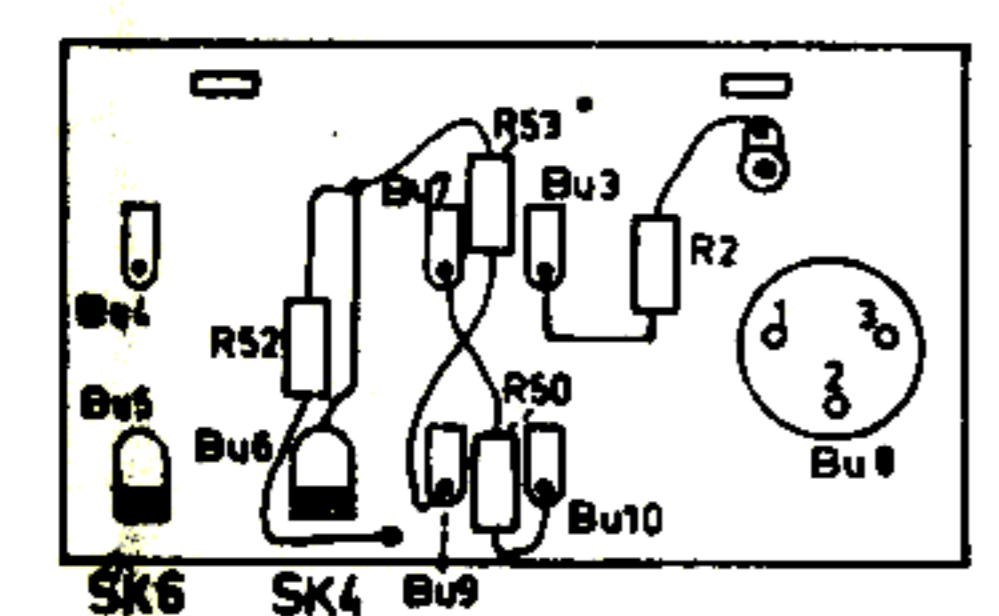
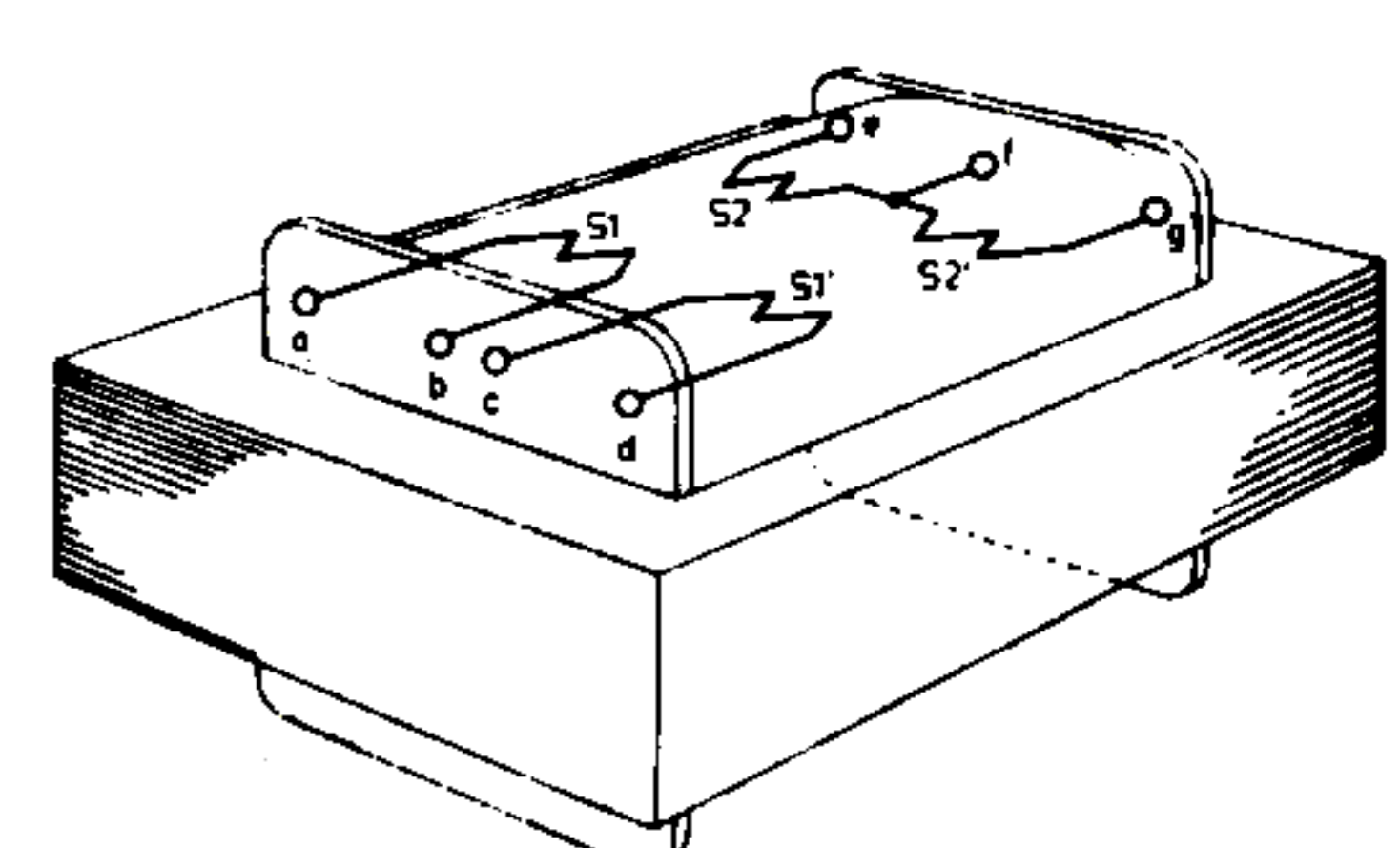

- PAPER CAPACITOR 400V 10% 906/...
- CERAMIC CAPACITOR 700V 2% 904/...
- WIRE TRIMMER 907/...
- CARBON RESISTOR 1W 10% 900/...
- CARBON RESISTOR 1/2W 2% 901/...
- CARBON RESISTOR 1/2W 10% 902/...