**DF 97****DF 96****DK 92****DF 96****DF 96****DAF 96****DL 96**

STROME MIT MULTITEST 5, SPANNUNGEN MIT
NOMENVOLTMETER AUF UAW BEI NETZ 230V.
GEMESSEN ODER BEI KW GEMESSEN.

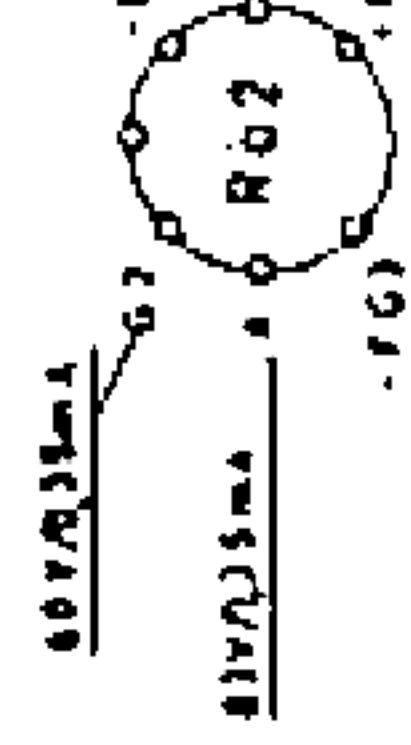
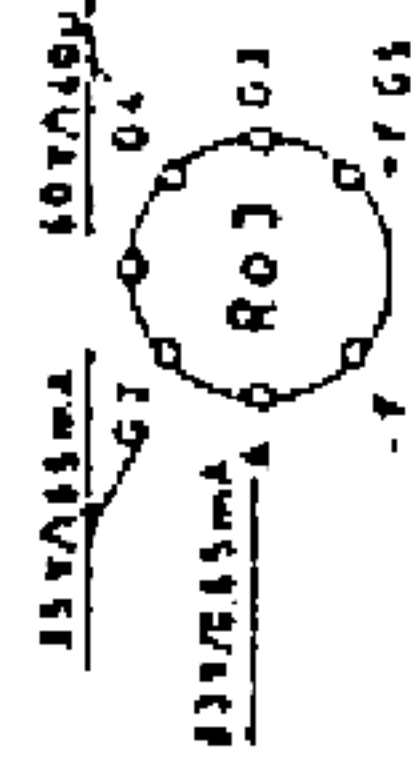
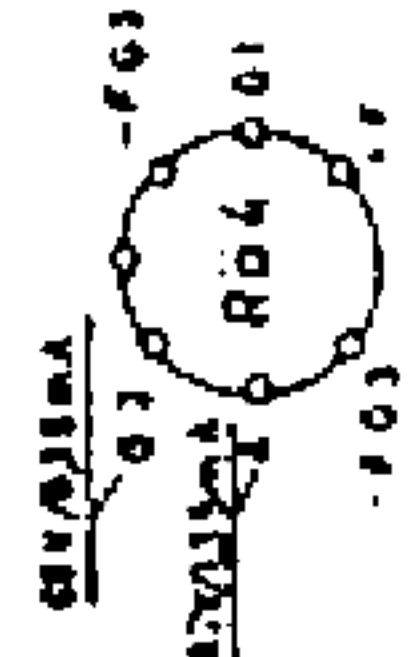
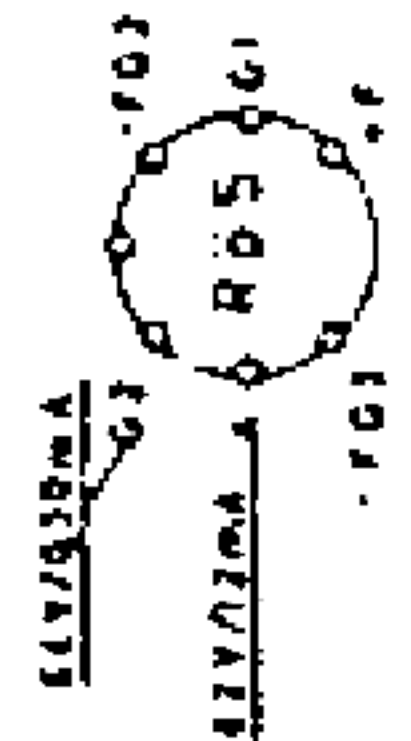
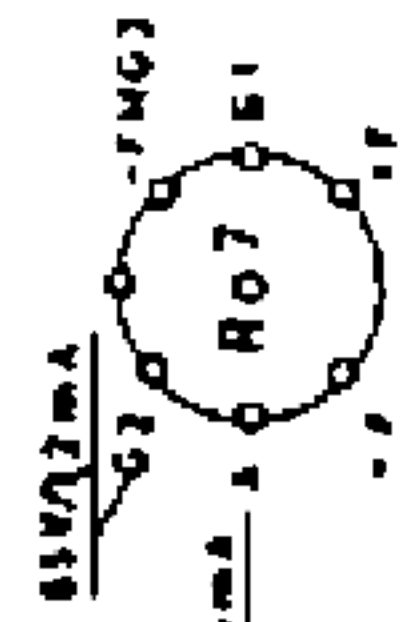
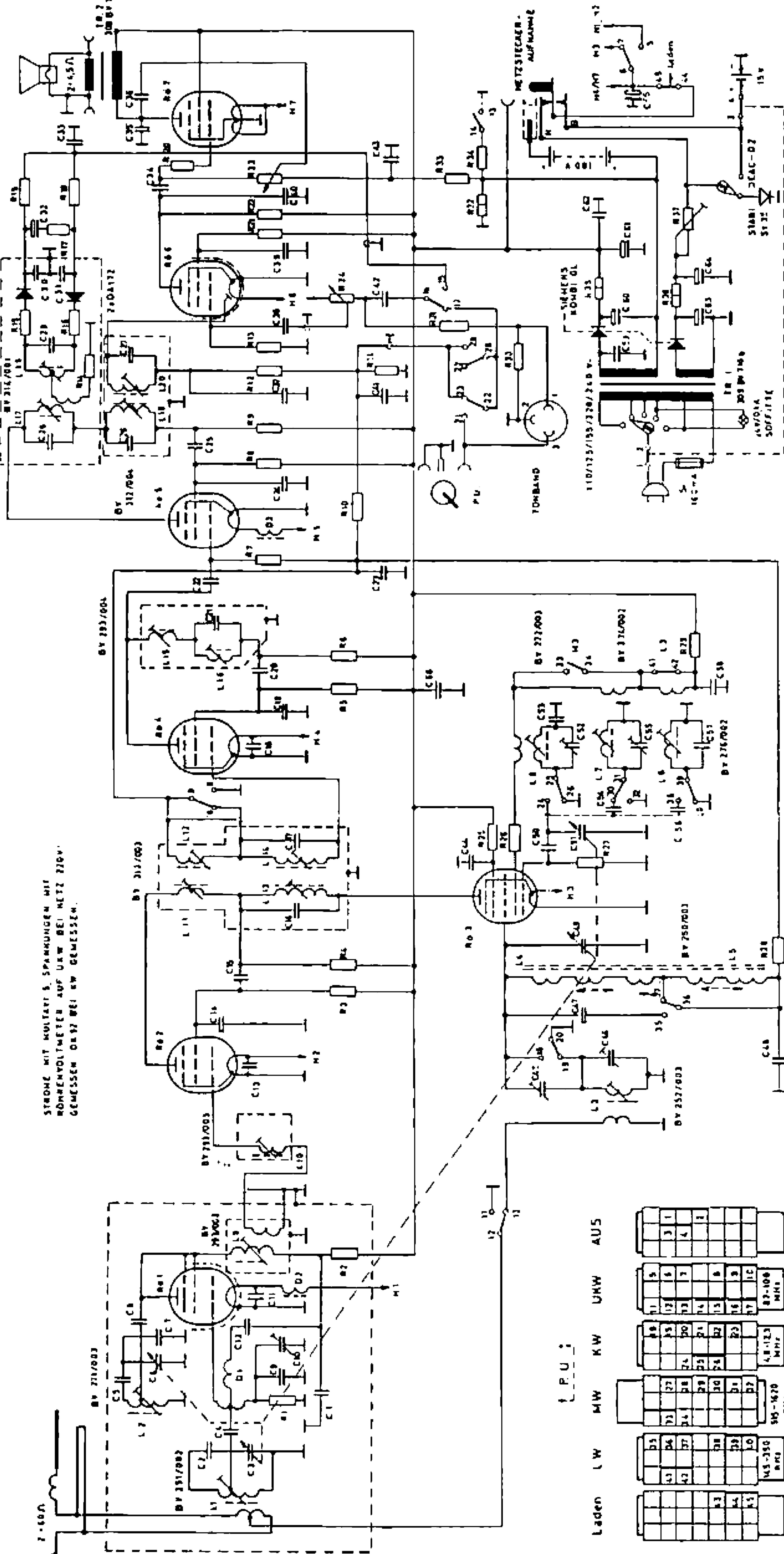
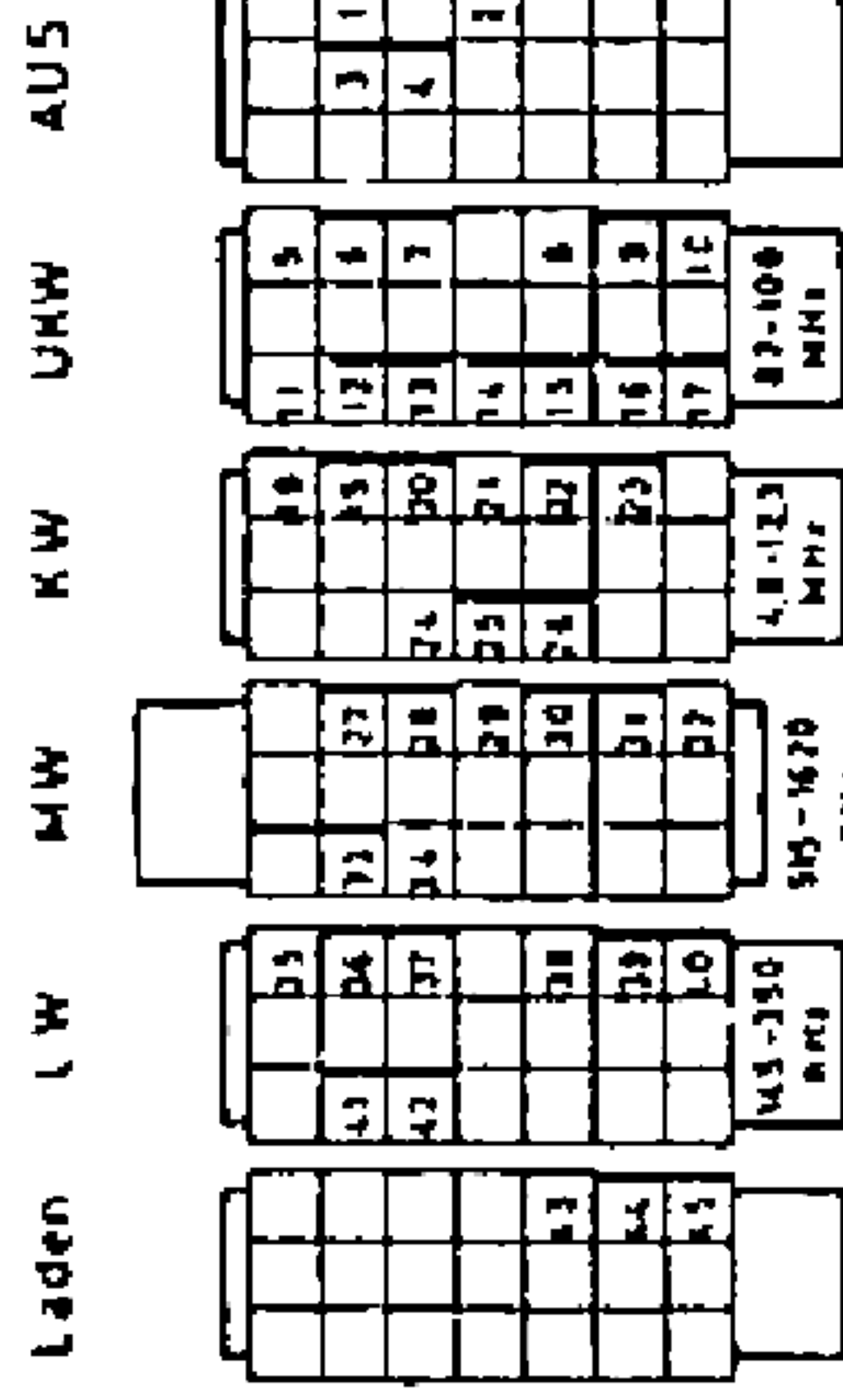

Pos.	1	2	3	4	5	6	7	8	9	10	11	12	13	14	15	16	17	18	19	20	21	22	23	24	25	26	27	28	29	30	31	32	33	34	35	36	37	38	39	40	41	42	43	44	45	46					
C-Skala WERT	500	300	200	150	100	75	50	25	20	15	10	7,5	5	3,5	2,5	1,5	1	0,7	0,5	0,3	0,2	0,15	0,1	0,075	0,05	0,035	0,025	0,015	0,01	0,0075	0,005	0,0035	0,0025	0,0015	0,001	0,00075	0,0005	0,00035	0,00025	0,00015	0,0001	0,000075	0,00005	0,000035	0,000025	0,000015	0,00001				
R-Skala WERT	100	500	1000	5000	10000	50000	100000	500000	1000000	5000000	10000000	50000000	100000000	500000000	1000000000	5000000000	10000000000	50000000000	100000000000	500000000000	1000000000000	5000000000000	10000000000000	50000000000000	100000000000000	500000000000000	1000000000000000	5000000000000000	10000000000000000	50000000000000000	100000000000000000	500000000000000000	1000000000000000000	5000000000000000000	10000000000000000000	50000000000000000000	100000000000000000000	500000000000000000000	1000000000000000000000	5000000000000000000000	10000000000000000000000	50000000000000000000000	100000000000000000000000	500000000000000000000000	1000000000000000000000000	5000000000000000000000000	10000000000000000000000000	50000000000000000000000000	100000000000000000000000000	500000000000000000000000000	1000000000000000000000000000

C-Skala WERT → MHz
R-Skala WERT → MHz