

MODELS 8D15,  
8D16; Ch. 8D1

## RADIO TILT-OUT DOOR ADJUSTMENT

If the door on the radio tilt-out assembly is shifted to one side, readjustment of the tilt-out arm will correct the difficulty. If the tilt-out door is too far to the right, the right-hand tilt-out arm can be sprung. If the door is too far to the left, the left-hand arm can be sprung. The tilt-out arms are sprung by holding the lower end of the arm against its bracket and prying the arm

toward the chassis with a screwdriver. The screwdriver is used as a lever between the tilt-out arm and the side of the radio compartment.

In the event that the bottom edge of the radio tilt-out door rubs, it can be planed off slightly. Care must be exercised in doing this in order that the door is not marred. Hold the plane flat against the beveled bottom edge of the door while planing off a small amount.

# ALIGNMENT PROCEDURE

## FM ALIGNMENT EQUIPMENT

The model 8D1 chassis should be aligned only with an AM signal generator and a vacuum tube voltmeter. Any standard brand vacuum tube voltmeter with a DC scale of not over 5 volts is suitable. A 3-volt zero center scale is desirable. A signal generator with a frequency range up to 110 MC. is desirable. It is possible however, to align the receiver with a signal generator going to 20 or 30 megacycles, by using the harmonics of these lower frequencies. To do this merely set the signal generator dial as follows and align exactly as explained in the alignment instructions.

Where alignment chart specifies 109 MC., set signal generator to highest available frequency of the following:

109. MC	27.25 MC
54.50 MC	21.80 MC
36.33 MC	18.17 MC

Where alignment chart specifies 102 MC., set signal generator to highest available frequency of the following:

102. MC	25.50 MC
51. MC	20.40 MC
34. MC	17. MC

Signal generators which do not tune to 110 MC or whose harmonics are not strong enough, cannot be used for FM alignment.

## POINTER SETTING

With the gang closed, the pointer should be at the position as shown in the stringing diagram (Fig. 4), that is, the bottom edge of the pointer should line up with the top of the "MC" lettering on the dial scale. If the pointer is in a different position, move it by hand while keeping the gang closed.

## TRIMMER IDENTIFICATION CHART

Trimmer Symbol	Function
A... T3	Ratio Detector transformer
B... T2	2nd IF transformer (FM)
C... T2	2nd IF transformer (FM)
D... T1	1st IF transformer (FM)
E... T1	1st IF transformer (FM)
F... T3	Ratio Detector transformer
G... C38	FM oscillator trimmer
H... C5b	FM RF trimmer
I... T5	2nd IF transformer (AM)
J... T5	2nd IF transformer (AM)
K... T4	1st IF transformer (AM)
L... T4	1st IF transformer (AM)
M... C5d	AM oscillator trimmer
N... C5a	AM antenna trimmer

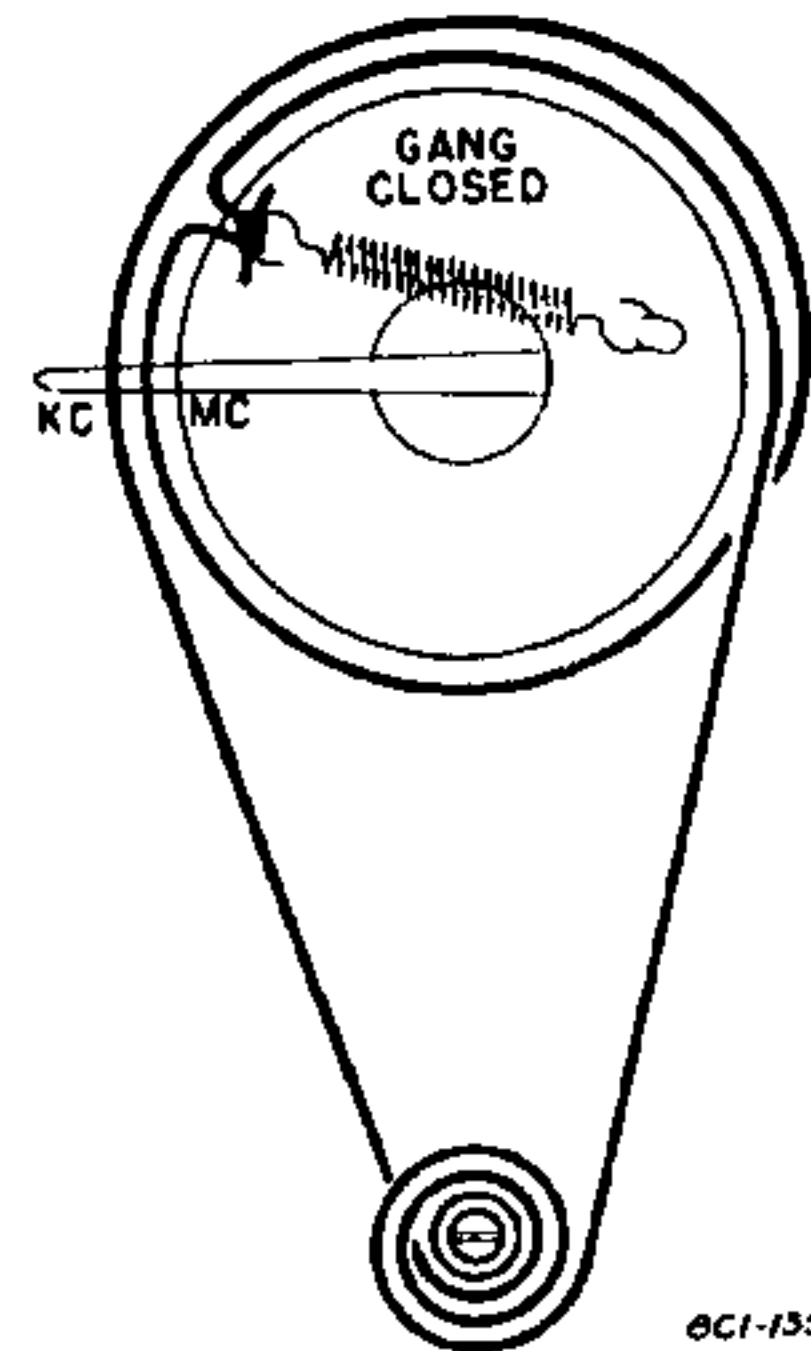

Fig. 4. Stringing Diagram

MODELS 8D15,  
8D16; Ch. 8D1

### SETTING SIGNAL GENERATOR TO CENTER OF I.F. SELECTIVITY CURVE

**CAUTION:** Due to the difficulty of setting a signal generator to the accuracy required by this operation, extreme care must be exercised in making each setting. Otherwise, improper alignment of the ratio detector and consequent audio distortion will result.

**EXAMPLE:** (See Figures 5 and 6)

Voltage reading in Step 4a is + 1.5 volts.

Generator frequency on low side of 10.7 MC for a reading of + 1 volt DC = 10.640 MC.

Generator frequency on high side of 10.7 MC for a reading of + 1 volt DC = 10.800 MC.

Center frequency is obtained by adding 10.640 and 10.800, then dividing by 2. For these readings it will be 10.72 MC.

Set generator frequency to 10.72 MC as this is center of selectivity curve as shown in Figure 6.

**Note:** Numerical vernier dial readings may be used instead of MC.

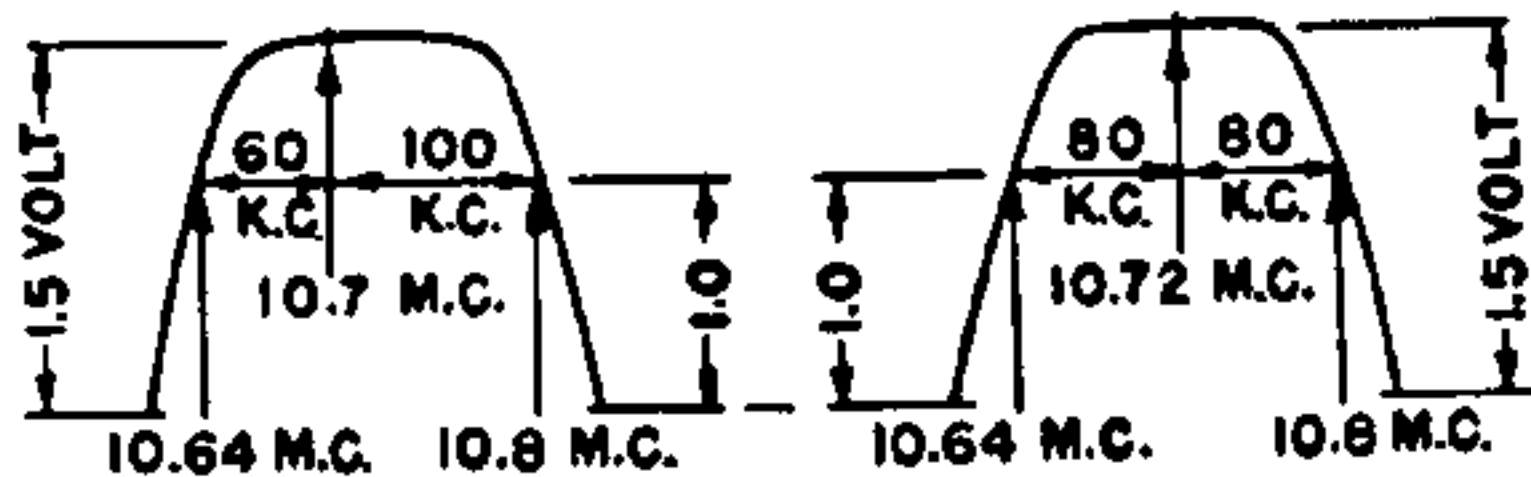

Fig. 5

Fig. 6

### TYPICAL SELECTIVITY CURVES

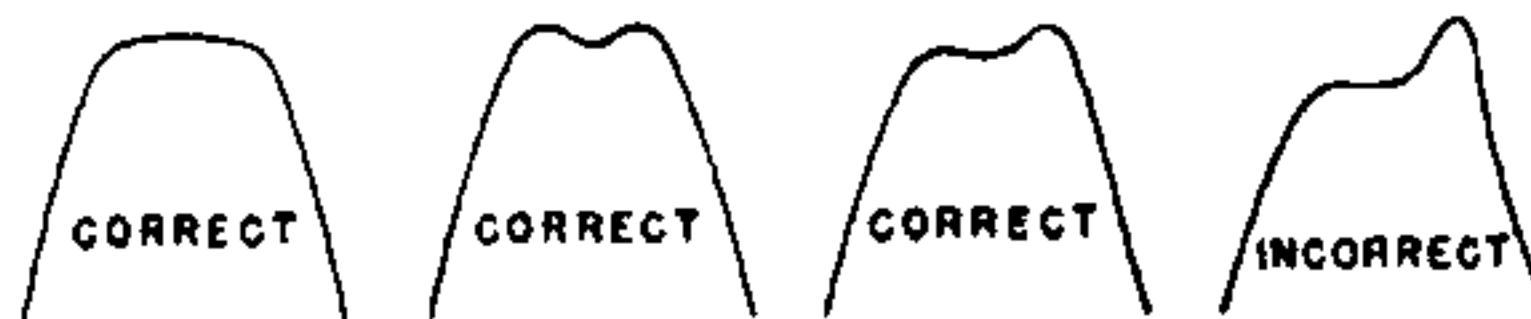

Fig. 7.

Fig. 8.

Fig. 9.

Fig. 10.

### FM RF ALIGNMENT PROCEDURE

	Connect Signal Generator	Generator Frequency	Receiver Dial Setting	Output Indicator and Connections	Adjust as Follows
6	FM ant. terminal.	109 MC† (unmodulated).	Tuning gang wide open	Connect VTVM (DC probe) from point "W" to ground.	*G for maximum VTVM reading.
7	"	102 MC† (unmodulated).	102 MC	"	*Tune in generator signal on receiver. Adjust H for max. VTVM reading

\* It is advisable to adjust generator output so VTVM readings do not exceed approximately + 1.5 V. DC after peaking.  
† If your signal generator does not reach this frequency, use harmonics as described in "FM Alignment" on page 8.

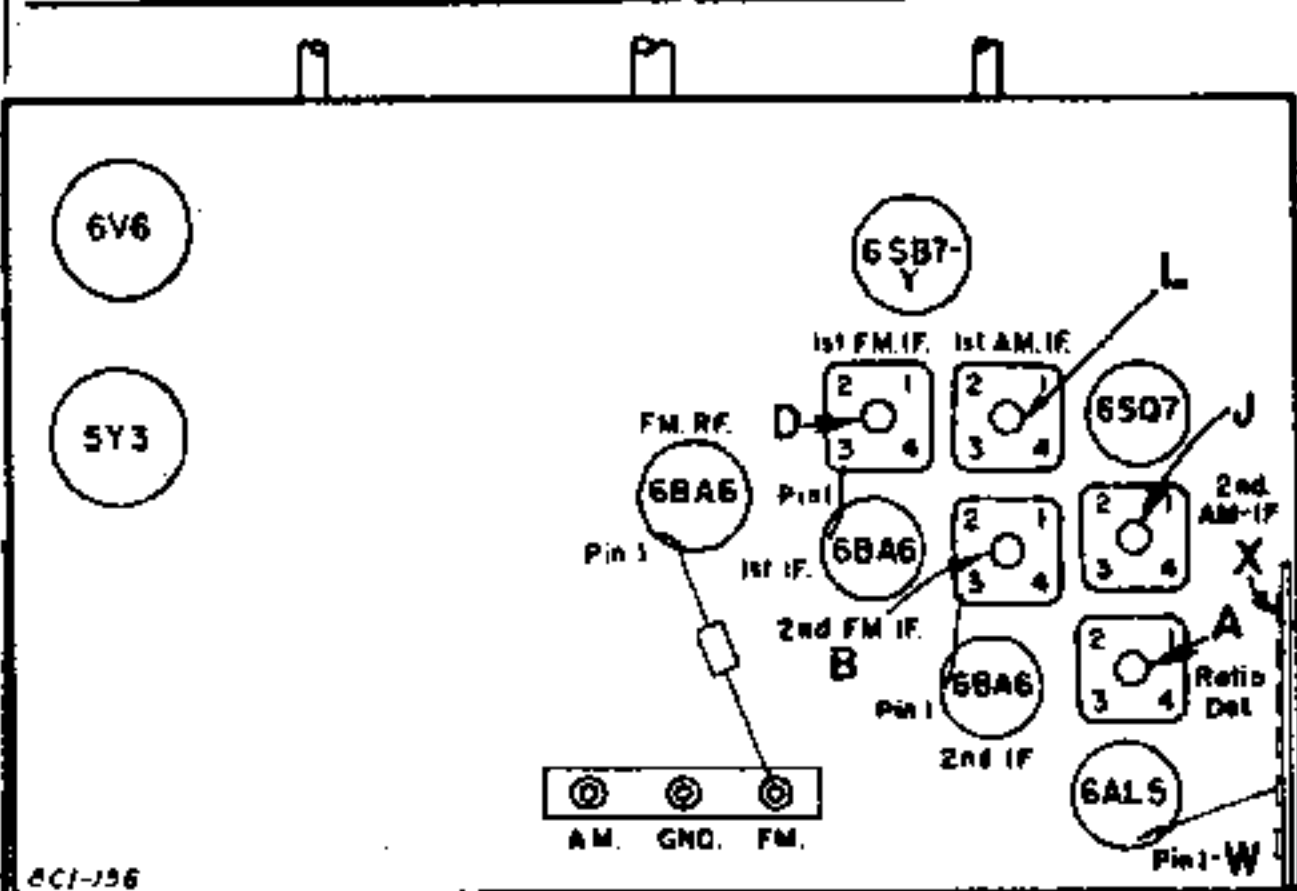

Fig. 11. Bottom Trimmer Location

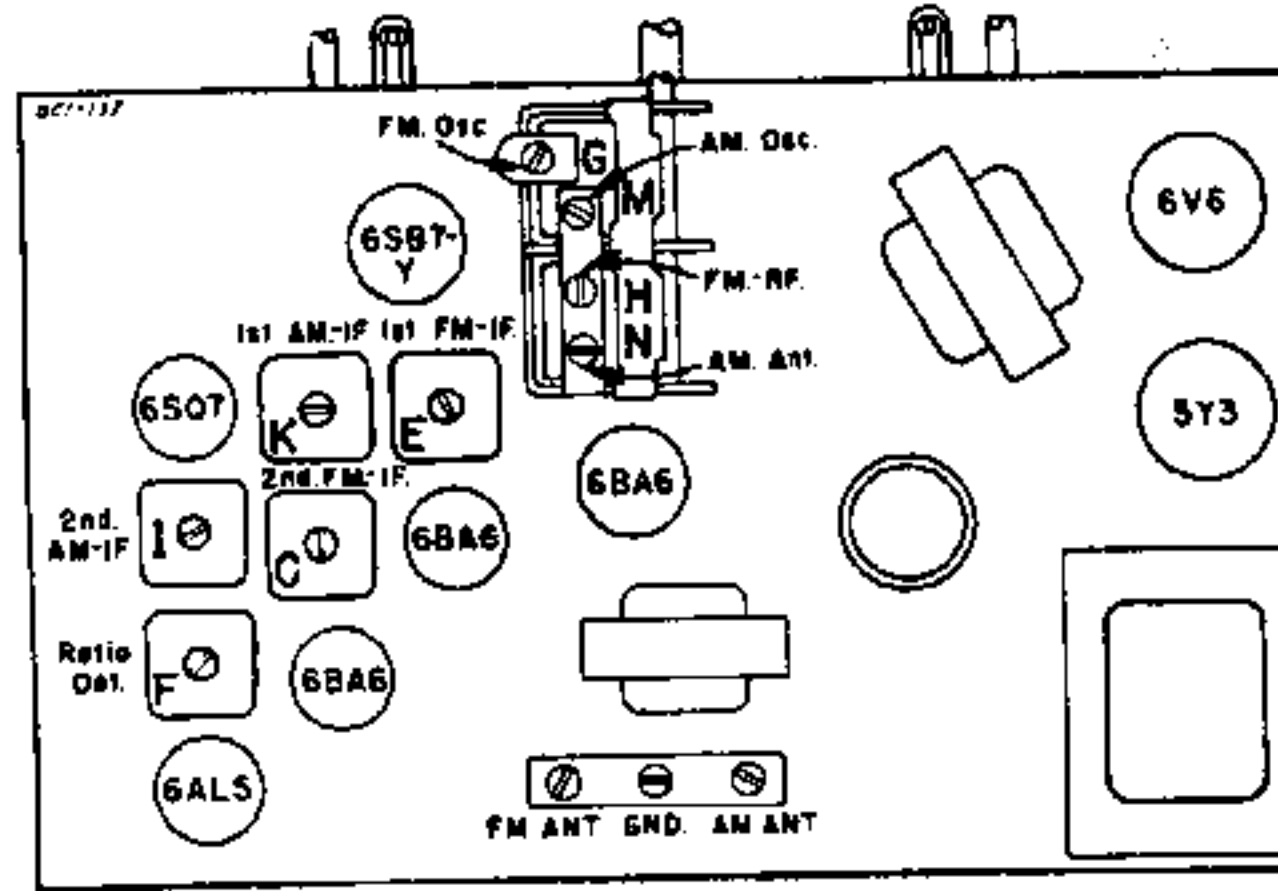

Fig. 12. Top Trimmer Location

### AM ALIGNMENT PROCEDURE

- Use regular output meter connected across speaker voice coil.
- Turn receiver Volume Control full on; Tone Control full treble.

- Band Switch in center position.
- Use lowest output setting of signal generator that gives a satisfactory reading on meter.

	Connect Signal Generator	Dummy Antenna Between Radio and Signal Generator	Signal Generator Frequency	Receiver Dial Setting	Adj. Trimmers in Following Order to Max.
1	6SB7-Y (Pin #8)	.1 MFD	455 KC	Tuning gang wide open	I, J, K, L
2	To loop ant. terminal	Direct connection	1620 KC	Tuning gang wide open	M
Set Receiver Chassis on table next to back of cabinet. Connect Loop Antenna to Receiver.					
3	Place generator lead close to loop of set to obtain adequate signal. No actual connection (signal by radiation).		1400 KC	Tune in signal	N

MODELS 8D15,  
8D16; Ch. 8D1

### IMPORTANT PRELIMINARY ALIGNMENT STEPS

In FM alignment, it is essential that every step be followed. Especially important is picking the center of the I.F. curve (step 4 in the FM-I.F. alignment instructions). During this portion of the alignment it is necessary to tune the signal generator very carefully; it may necessitate having to estimate the dial readings to a tenth of a division.

- Check the set screws that hold the tuning drum to the shaft to see that they are tight and that the drum has not slipped on the shaft. The correct position of the drum can be seen in the stringing diagram.
- With the gang closed, the pointer should be at the position as shown in the stringing diagram, that is, the

bottom edge of the pointer should line up with the top of the "MC" lettering on the dial scale. If the pointer is in a different position, move it by hand while keeping the gang closed.

- Be sure both the set and the signal generator are thoroughly warmed up before starting alignment.

### FM I.F. AND RATIO DETECTOR ALIGNMENT

- Keep output indicator leads well separated from signal generator leads and chassis wiring.
- Band switch in FM position (fully to the left).
- While peaking IF's, keep reducing signal generator

output so VTVM reading is approximately +1.5 volts DC with exception of Step #5.

- Speaker must be connected during alignment.
- FM antenna disconnected during alignment.

### I.F. SLUG INFORMATION

To avoid splitting the slotted head of the powdered iron core tuning slug in the I.F. transformers, use a screw-driver with a blade  $\frac{1}{8}$ " wide for I.F. alignment.

Under normal operating conditions, mis-alignment of slug-tuned circuits with age is slight. Therefore, re-alignment of the I.F. transformers should be accomplished by only a slight adjustment of the slugs.

Before proceeding, be sure to follow all steps listed above, under "Important Preliminary Alignment Steps."

	Connect Signal Generator	Generator Frequency	Receiver Dial Setting	Output Indicator and Special Connections	Adjust as Follows (very carefully)
1	Thru .001 cond. to pin # 1 of 6BA6 RF amplifier**	10.7 MC unmodulated.	Tuning gang wide open	Connect VTVM (DC probe) from point "W" to ground. (See Fig. 11.)	"A" (ratio detector primary) for maximum reading on VTVM.
2	"	"	"	" "	Iron cores "B" and "C" (2nd IF trans.) for maximum reading on VTVM.
3	"	"	"	" "	Iron cores "D" and "E" for maximum on VTVM. Re-adjust A, B, C, D, E, for maximum. (Keep reducing generator output to keep VTVM at 1.5 volts).
4	"	a. Reduce output of signal generator until VTVM reads exactly +1.5 volts DC. b. Tune generator frequency above 10.7 MC until VTVM reads exactly +1.0 volt. Note exact generator frequency. Extreme care in reading this is essential. c. Tune generator frequency below 10.7 MC until VTVM reads exactly +1.0 volt. Note exact generator frequency. Extreme care in reading this is essential. d. Add generator frequency in step c to generator frequency in step b and divide by 2. The result is the center frequency of the IF curve to be used in step 5. See example on next page. e. Tune generator frequency above and below 10.7 MC and note voltage reading on VTVM at different frequency points until you have a good impression of the shape of the selectivity curve. If you have two peaks as in Figures 9 or 10, note readings (voltage) of both peaks. If one peak is over 20% higher than the other one, it will be necessary to realign IF's. A selectivity curve that would require realignment is illustrated by Figure 10.			
5	"	Center of IF selectivity curve per step 4d above. See "EXAMPLE" on next page.	Tuning gang wide open	Connect VTVM (DC probe) from point "X" to ground. (See Fig. 11.)	Iron core "F" (ratio detector secondary) for zero voltage reading on VTVM. (The correct zero point is located between a positive and a negative maximum.)

If any adjustments were very far off, it is desirable to repeat steps 3, 4 and 5.  
 \*\*Do not feed I.F. signal into converter grid as this will cause mis-alignment.

MODELS 8D15,  
8D16; Ch. 8D1

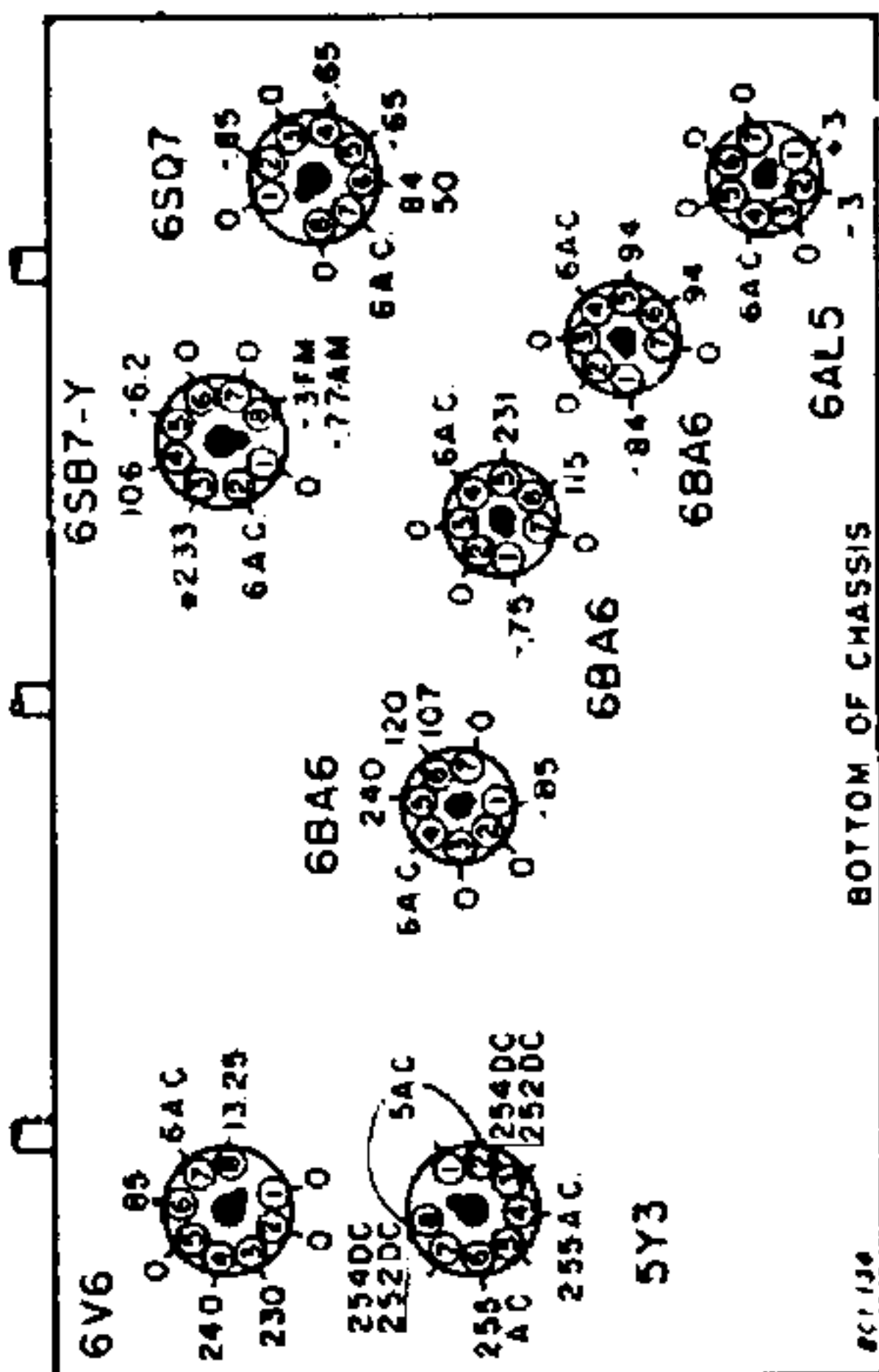

**MISCELLANEOUS**

Description	Part No.
Bracket, Shipping Retainer	15A 379
Plate, Cover (Chassis Mtg.)	15A 146
Socket, Miniature Tube	87A 3-4
Socket, Oval	87A 5-1
Strip, Shipping (for Changer Tilt-Out)	15C 193
Strip, Shipping (for Radio Tilt-Out)	15A 178
Terminal Board (Mounted on cabinet)	108 3-3
Door Knob, Record Storage Compart.	98A 52-3
Grille Cloth (2 pieces)	98A 52-6
Grammel, Rubber	
for mounting Chassis	12A 1-11
for Changer Tilt-Out	12A 1-1
Knobs, Radios	33B 31-1
"FM BC PH"	33B 31-2
"Volume" and "On-Off Tones"	33A 13-4
Rubber Chassis	
for Radio Tilt Out Brackets	12A 9-1
(2 3/4" x 1 1/4" x 1/8" overall)	
for Dial Scale Inner edge 29 1/2"	12A 20-3
Rubber Strip, Sponge	12A 11
for Chassis Mounting	
(3 1/2" x 1 1/2" x 3/16")	12A 11-1
(3 1/2" x 1 1/2" x 1/8")	12A 5-4
for Door Black (3 1/2" x 2 1/2" x 1/8")	12A 5-3
for Door Panel (12 1/4" x 1 1/4" x 1/8")	
for Tilt Out Record Changer Bumper	12A 5-5
(1 1/2" x 1 1/4" x 1/8")	
Shoulder Eye Bolt	1A 87-1
for adjusting Radio Tilt Out Spring	1A 87-2
for adjusting Radio Tilt Out Spring	1A 87-3

frequencies. When replacing condensers it is important that they be replaced with condensers of identical capacity values, tolerances, temperature coefficients and construction.

**FM SERVICE**

Much of FM service is similar to the usual service necessary for AM receivers such as voltage analysis, parts replacement, etc. The chief differences arise because of the considerably higher frequencies used in FM operation, and because of the different type of second detector needed in FM.

The higher frequencies involved means that more care must be exercised in location and length of leads. Leads tend to act as small inductances or capacities at high frequency and hence may appreciably alter the electrical characteristics of a circuit. For this reason, ground connections should always be maintained as originally made in the set. Also note that in certain circuits, the type by-pass condenser used is critical at the high FM

In some sets, built-in FM antenna LI was omitted; loop L2 (used as FM-AM antenna) was connected across outer terminal ("AM" to "FM"). When using external FM antenna, make connections as shown.

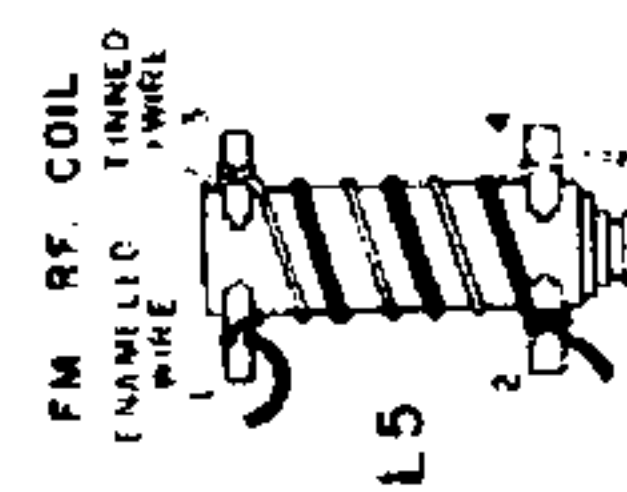
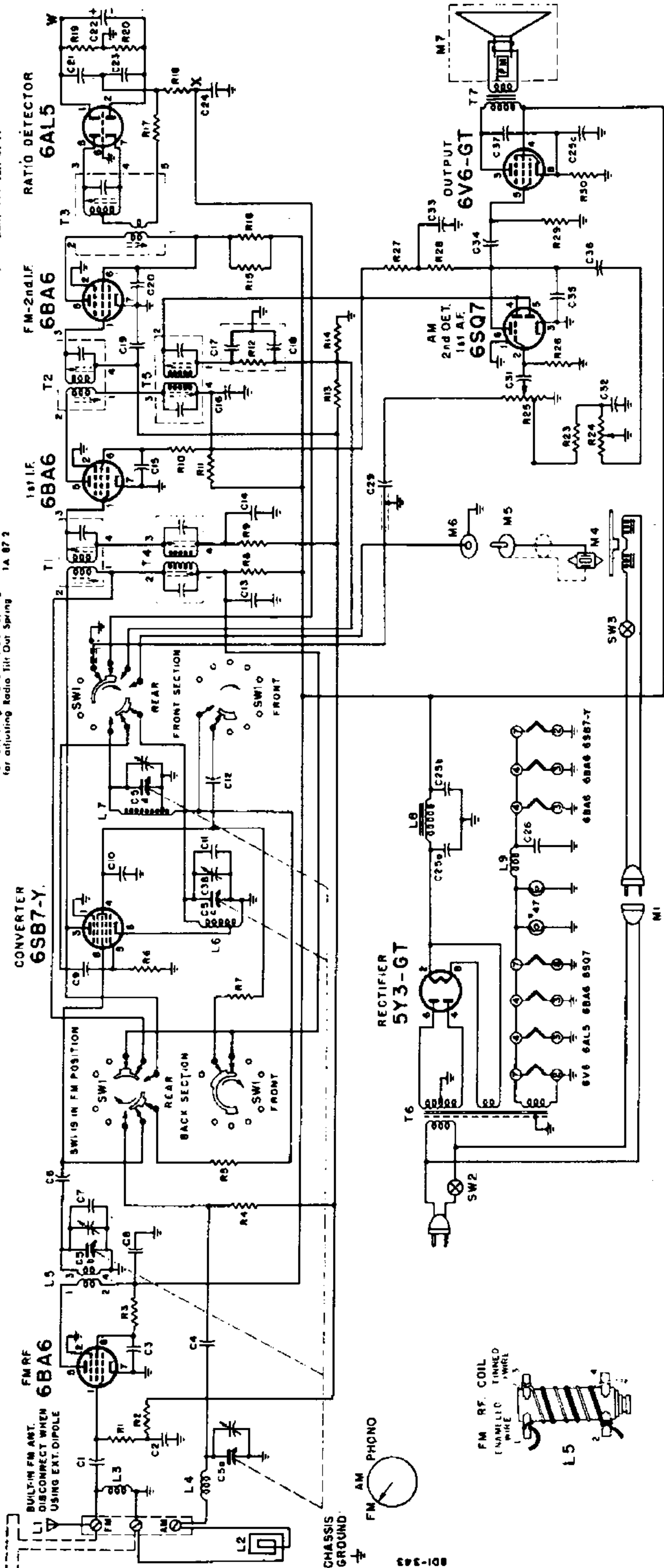



**RESISTORS**

Symbol	Description	Part No.
R1	390 Ohms, 1/2 Watt	60B 8-391
R2	470,000 Ohms, 1/2 Watt	60B 8-474
R3	22,000 Ohms, 1 Watt	60B 14-223
R4	1 Megohm, 1/2 Watt	60B 9-105
R5	47,000 Ohms, 1/2 Watt	60B 8-473
R6	47,000 Ohms, 1/2 Watt	60B 8-473
R7	15,000 Ohms, 2 Watt	60B 20-153
R8	470 Ohms, 1/2 Watt	60B 8-471
R9	470,000 Ohms, 1/2 Watt	60B 8-474
R10	27,000 Ohms, 1 Watt	60B 14-273
R11	470 Ohms, 1/2 Watt	60B 8-471
*R12	47,000 Ohms, 1/4 Watt	
R13	220,000 Ohms, 1/2 Watt	60B 8-224
R14	220,000 Ohms, 1/2 Watt	60B 8-224
R15	15,000 Ohms, 2 Watt	60B 20-153
R16	27,000 Ohms, 1/2 Watt	60B 8-273
R17	390 Ohms, 1/2 Watt	60B 8-391
R18	27,000 Ohms, 1 Watt	60B 14-273
R19	6,800 Ohms, 1/2 Watt, 5%	60B 7-682
R20	6,800 Ohms, 1/2 Watt, 5%	60B 7-682
R23	47,000 Ohms, 1/2 Watt	60B 8-473
R24	2 Megohms Tone Control (Includes ON-OFF Switch SW2)	75B 1-24
R25	1 Megohm Volume Control (Tapped at 500,000 Ohms)	75B 2-10
R26	10 Megohms, 1/2 Watt	60B 9-106
R27	22,000 Ohms, 1/2 Watt	60B 8-223
R28	470,000 Ohms, 1/2 Watt	60B 8-474
R29	470,000 Ohms, 1/2 Watt	60B 8-474
R30	390 Ohms, 1 Watt	60B 14-391

**CONDENSERS**

Symbol	Description	Part No.
C1	100 mmfd., Ceramic	65B 6-3
C2	.01 mfd., 400 Volts, Paper	64B 1-25
C3	.0015 mfd., "Hi-K" Ceramic	65A 14-1
C4	140 mmfd., 3%, Silver Mica	65B 1-26
C5a	486 mmfd. (max.), AM RF	} Gang Cond. 68B 16
C5b	15 mmfd. (max.), FM RF	
C5c	15 mmfd. (max.), FM Osc.	
C5d	143 mmfd. (max.), AM Osc.	
C6	22 mmfd., 5%, Zero Temp. Coeff., Ceramic	65B 6-47
C7	7 mmfd., ±1 mmfd., -0.00047 Temp. Coeff., Ceramic	65B 6-45
C8	.01 mfd., 400 Volts, Paper	64B 1-25
C9	35 mmfd., 5%, Zero Temp. Coeff., Ceramic	65B 6-46
C10	100 mmfd., Mica	65B 7-17
C11	7 mmfd., ±1 mmfd., -0.00047 Temp. Coeff., Ceramic	65B 6-45
C12	.0015 mfd., "Hi-K" Ceramic	65A 14-1
C13	.01 mfd., 400 Volts, Paper	64B 1-25
C14	.01 mfd., 400 Volts, Paper	64B 1-25
C15	.005 mfd. min., Ceramic (Disc)	65A 10-1
C16	.01 mfd., 400 Volts, Paper	64B 1-25
*C17	100 mmfd., Ceramic	
*C18	100 mmfd., Ceramic	

\*Part of encased Diode Filter Unit 63A3-1. This unit consists of R12, C17, C18 (see schematic). If a section of the unit becomes defective, replace with exact duplicate or individual components of proper value.

**VOLTAGE CHART**

Symbol	Description	Part No.
C19	.01 mfd., 400 Volts, Paper	64B 1-25
C20	.005 mfd. min., Ceramic (Disc)	65A 10-1
C21	105 mmfd., 5%, -0.00075 Temp. Coeff., Ceramic	65B 6-9
C22	4 mfd., 150 Volts, Electrolytic	67A 4-2
C23	105 mmfd., 5%, -0.00075 Temp. Coeff., Ceramic	65B 6-9
C24	.002 mfd., 600 Volts, Paper	64B 1-14
C25a	30 mfd., 350 Volts	} Elect. .... 67C 6-25
C25b	30 mfd., 350 Volts	
C25c	20 mfd., 25 Volts	
C26	.01 mfd., 400 Volts, Paper	64B 1-25
C29	.005 mfd., 600 Volts, Paper	64B 1-12
C31	.005 mfd., 600 Volts, Paper	64B 1-12
C32	.01 mfd., 400 Volts, Paper	64B 1-25
C33	.1 mfd., 400 Volts, Paper	64B 1-20
C34	.01 mfd., 400 Volts, Paper	64B 1-25
C35	200 mmfd., 20%, Ceramic	65B 7-21
C36	.01 mfd., 400 Volts, Paper	64B 1-25
C37	.005 mfd., 600 Volts, Paper	64B 1-12
C38	2 1/2 to 6 mmfd., Trimmer, Silver Ceramic	66A 24-2

**COILS, TRANSFORMERS, ETC.**

Symbol	Description	Part No.
L1	Antenna, FM (90" of #22 wire)	
L2	Antenna, Loop (AM)	95A 24-2
L3	Choke, RF	AB103-33
L4	Coil, Loop Loading (AM)	69A 56
L5	Coil, RF (FM)	69A 53
L6	Coil, Oscillator (FM)	69A 54
L7	Coil, Oscillator (AM)	69A 20-1
L8	Choke, Filter	74A 10
L9	Choke, Filament	
	Approx. 10 turns (18") of solid #22 hook-up wire wound on C26. Solder one end to inside foil lead of C 26.	
T1	Transformer, 1st IF (FM)	72B 37
T2	Transformer, 2nd IF (FM)	72B 38
T3	Transformer, Ratio Detector	72B 39
T4	Transformer, 1st IF (AM)	72B 34
T5	Transformer, 2nd IF (AM)	72B 49
T6	Transformer, Power	80B 5
T7	Transformer, Output	79A 9
M7	Speaker 10" P.M. Dynamic	78B 28
SW1	Switch, Band (FM, AM, Phono)	77B 18
SW2	Switch, Power	Part of R24
SW3	Switch, Phono Motor (see Record Changer Manual)	
	Diode Filter (consists of R12, C17 and C18)	63A 3-1

**DIAL PARTS**

Description	Part No.
Dial Bulb, #47	81A 1-8
Dial Bulb Socket (with leads)	82A 8-3
Dial Cord (18")	50A 1-3
Dial Escutcheon and window (Radio)	23D 29-3
Dial Pointer, Plastic	A1685

- Line Voltage 117.
- Voltages measured with a vacuum tube voltmeter. Second voltage readings and A.C. voltages measured with a 1000 ohm-per-volt meter.

Description	Part No.
Dial Scale Assembly	A1676
Drum and Hub Assembly	A1318
Rubber Channel (inner edge of Dial Scale - 29 1/2")	12A 20-3
Screw, Escutcheon Mtg. (#3 x 1/2 OH WS)	1A15-6-58
Set Screw, Dial Drum, 8-32x1/4"	1A 5-59-0
Spring, Dial Cord	19B 1-3
Spring Clip, Painter	18A 5-2
Sleeve, Dial Tuning (brass)	27A 45

**PHONOGRAPH PARTS**

Symbol	Description	Part No.
Note: Check Record Changer model number and see proper service manual for complete parts list.		
M1	Cable and Socket, Phono Motor	89A6-5
M4	Cartridge, Dual Needle (includes needles)	409A11
	Needle, Phonograph (Long play)	98A 15-6
	Needle, Phonograph (Standard 78 RPM)	98A 15-7
M5	Plug, shielded cable	88A 2-3
M6	Socket, Phono Pickup	88A1
	Centerpost (for 7" record)	G400B 310
	Centerpost (for 10" or 12" records)	G400B 311
	Nut, Wing (for fastening Record Changer during shipment)	2A 5-9-2
	Shoulder Eye Bolt (for Tilt-Out Spring)	1A 87-1
	Spring, Clamping (for holding extra centerpost)	84A6
	Strip, Sponge Rubber (1/16x1/4x1")	12A 5-5
	Stud Bolt (for fastening changer during shipment)	1A80-5
	Tilt-Out Hinge Assembly Closest to Pickup Arm	AC118-2
	Farthest from Pickup Arm	AC118-1
	Tilt-Out Spring (2 1/4" long)	19 A15-1
	Tilt-Out Tie Bar	15B 126
	Tilt-Out Tie Rod	28A 22

**CABINET PARTS**

Description	Part No.
Back, Cabinet	43B 44
†Cabinet Walnut (8D15)	35E 88-1
Mahogany (8D16)	35E 88-2
Carton complete with fillers	44B 108
†Door, Radio and Phono Tilt-Out pair for Walnut (8D15)	98A 52-1
pair for Mahogany (8D16)	98A 52-2
†Door, Record Compartment Complete for Walnut (8D15)	98A 52-3
for Mahogany (8D16)	98A 52-4
Door Arm (see Ref. #5 in Fig. 1) Near center of cabinet	A1440
Nearest side of cabinet	A1441
Door Bracket (see Ref. #7 in Fig. 1) Near center of cabinet	A1438
Nearest side of cabinet	A1439

†Supplied only if old part cannot be repaired. When ordering, describe condition of old part in detail.

- Voltages read between socket terminals and ground, unless otherwise indicated.
- Band switch in FM position.
- Dial turned to low frequency end.
- Volume Control—minimum.