

Ned. Ver. v. Historie v/d Radio

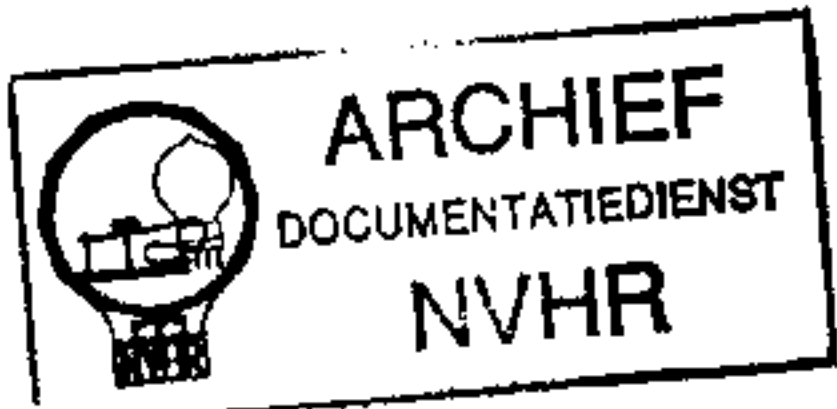

EKCO AC97

RG97 & ARG107

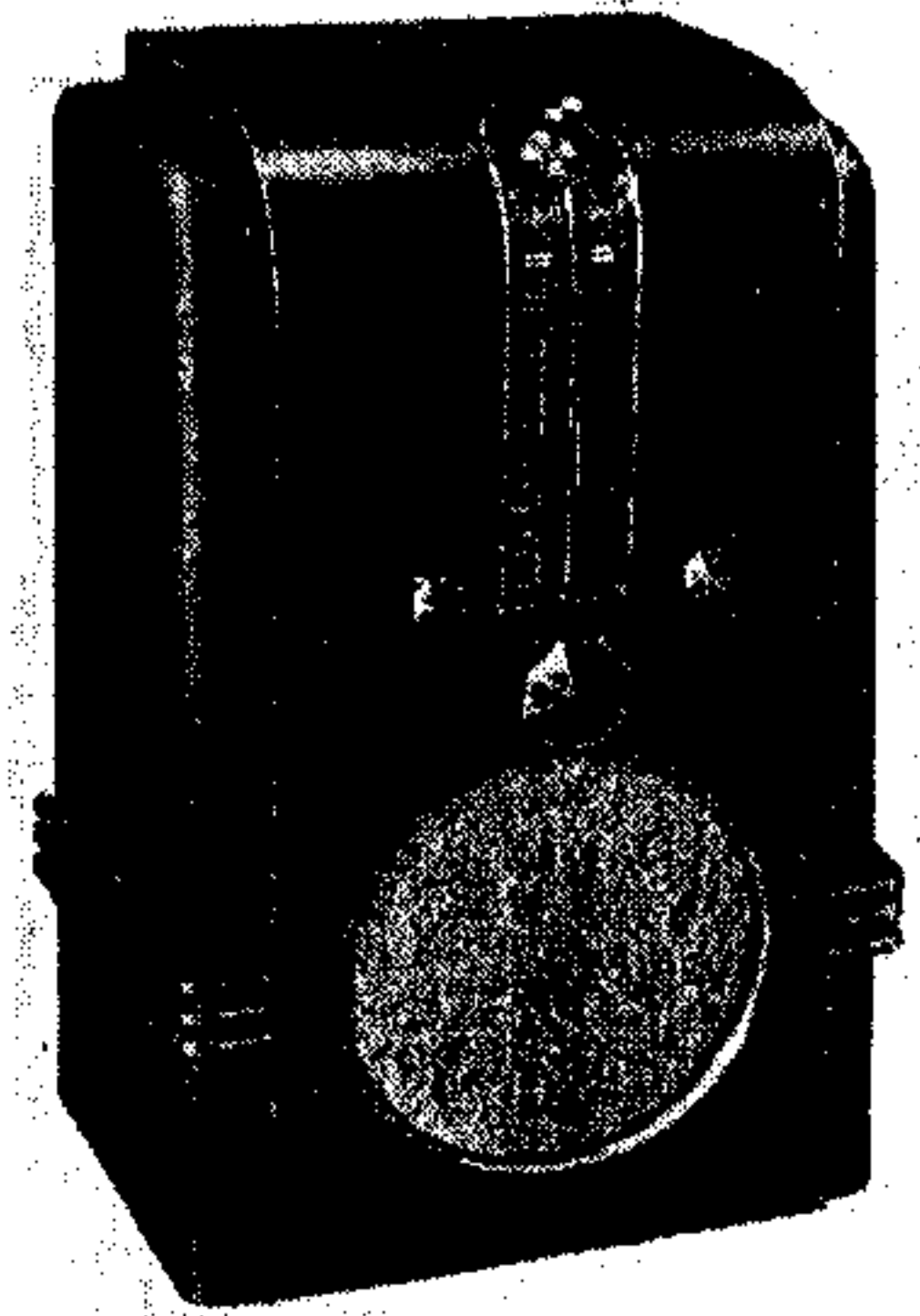

The Ekco AC97 in walnut.

VARIABLE band-width (two position) forms part of a three-position fidelity control in the Ekco AC97. The receiver is a 4-valve (plus rectifier) 2-band superhet, designed to operate from AC mains of 200-250 V, 40-80 c/s.

A triode output valve is employed, and a muting switch provides silent tuning. The receiver is available in walnut or black and ivory finish.

In the radiogram version RG97 the receiver chassis is like that in the table model, but the tuning indicator is used as a pick-up amplifier. This is explained under "Radiogram Modifications." The ARG107 employs the same chassis as the RG97, but it is fitted with an automatic record changer.

Release dates and original prices: AC97 walnut, July, 1936, £13 2s. 6d.; black and ivory, July, 1936, £13 13s.; RG97, July, 1936, £23 2s.; ARG107, September, 1936, £30 9s.

CIRCUIT DESCRIPTION

Aerial input via series coupling condenser **C1** and tapping on **L2** (MW), or coupling coil **L1** (LW) to inductively coupled band-pass filter. Primary coils **L2, L3** are tuned by **C30**; secondary coils **L4, L5** are tuned by **C32**. Coupling by mutual inductance of windings. Image suppression via pre-set condenser **C29**.

First valve (**V1, Mullard metallised FC4**) is an octode operating as frequency changer with electron coupling. Oscilla-

tor grid coils **L6** (MW) and **L7** (LW) are tuned by **C34**. Parallel trimming by **C35** (MW). Tracking by specially shaped vanes of **C34** (MW), and series condensers **C6, C36** (LW). Reaction is applied from anode via coils **L8** and **L9**.

Second valve (**V2, Mullard metallised VP4B** or **Ekco VP41**) is a variable-mu RF pentode operating as intermediate frequency amplifier with tuned-primary, tuned-secondary, transformer couplings **C37, L10, C3, L11, C38** and **C39, L12, L13, C40**. Two-position band-width adjustment is provided by including series resistors **R3** and **R4** in primary and secondary circuits of the first transformer in the high fidelity position. In the selective positions **S7** and **S8**, which are operated by the fidelity control, close to short-circuit the resistors.

Intermediate frequency 126.5 kc/s.

Diode second detector is part of double diode triode valve (**V3, Mullard metallised TDD4**). Audio frequency component in rectified output is developed across load resistor **R10** and passed via AF coupling condenser **C17** and manual volume control **R14** to control grid of triode section.

IF filtering by **C10, R9, C11**. Provision for connection of gramophone pick-up across **R14** and its decoupling circuit **R15, C18**. DC potential developed across **R10** also appears across the potential divider **R12, R13**, and that across **R13** is applied as control voltage between grid and cathode of cathode-ray tuning indicator (**T.I., Mullard TV4**).

Second diode of **V3**, fed from **V2** anode via **C16**, provides DC potentials which are developed across load resistors **R20** and **R21** and fed back through decoupling circuits as GB to FC and IF valves, giving automatic volume control. GB potential for **V3** triode and AVC delay potential are obtained from the HT potential divider **R17, R18, R19**.

Parallel-fed auto-transformer coupling by **R16, C19, T1, C20** and **C21** between **V3** triode and directly-heated filament output valve (**V4, Mullard ACO42**), which has a 2-volt filament fed from a separate secondary winding on the mains transformer, shunted by variable potentiometer **R24**.

A whistle rejector circuit **L14, C41**, tuned to 9 kc/s, is inserted in the control grid lead to eliminate adjacent transmitter heterodynes, prevalent at that fre-

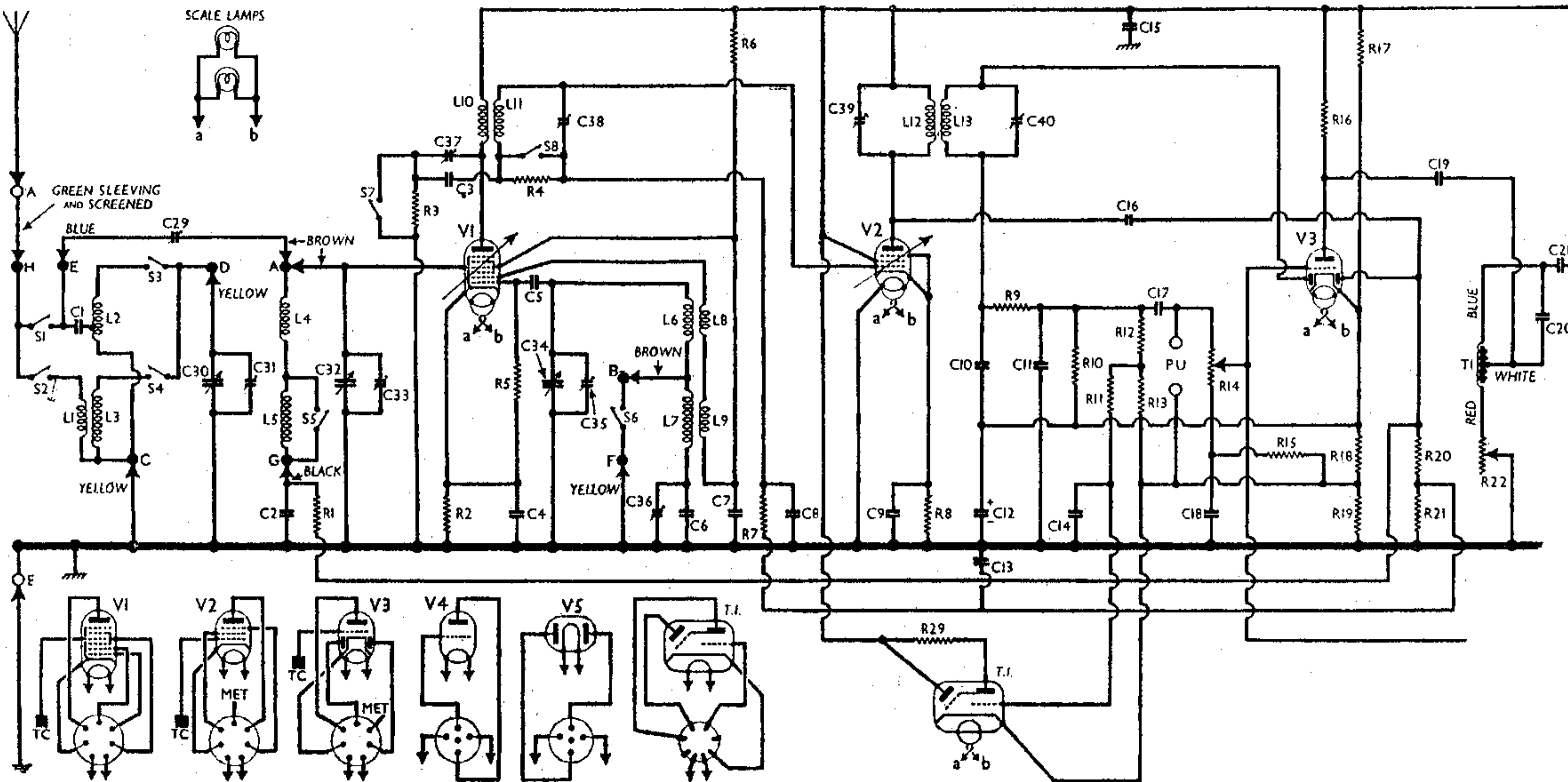

Under - chassis view. The connecting tags of the L1-L5 coil unit are lettered to agree with the lettering in the circuit diagram. Note that S6 is in this unit. A diagram of the S1-S6 switch unit appears in col. 3 overleaf. The letters X, Y, Z refer to the tags of the silent tuning switch. The whistle rejector L14, C41 is omitted in later versions. R1 is made up of two resistors in series.

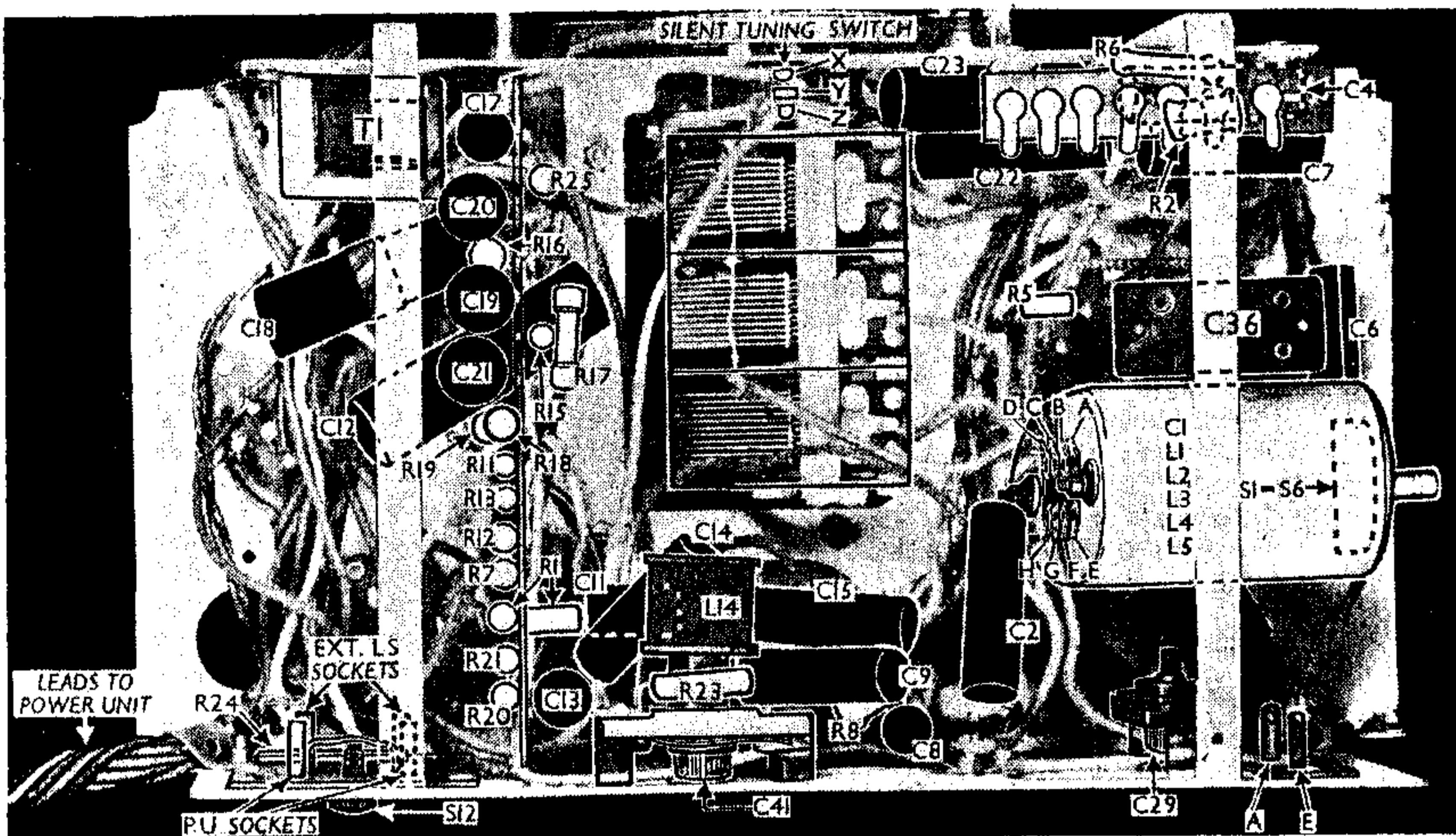

quency when the receiver was produced.

The values of C19, C20, C21 and the inductance of T1 are carefully chosen to give a rising bass characteristic, while R22, which is ganged with R14, compensates for the normal loss of bass at low volume levels.

In order to suppress inter-station noise, a silent tuning device is employed. Its contacts, marked X, Y and Z in the diagram, are so arranged that when the tuning control knob is pressed, X closes to Y before Y contacts Z. The potential thus applied to V3 triode control grid is stored in C18, and remains effective for about two seconds, during which period the receiver is muted.

Three position tone control L15, C22, C23 and C24 is controlled by switches S9, S10, S11 which are ganged with S7, S8 to form part of the fidelity control. Provision for connection of a low impedance external speaker across output transformer secondary T2, while S12 permits the internal speaker to be muted.

HT current is supplied by full-wave rectifying valve (V5, Mullard 1W4/350). Smoothing by speaker field L18 (in negative HT lead), R25 (in HT positive lead) and electrolytic condensers C25, C26 and C27. GB potential for V4 is obtained from the junction of R28 and R27, which form a potential divider across the speaker field.

VALVE ANALYSIS

Valve voltages and currents given in the table below are approximately those to be expected in an average chassis.

The receiver should be operating with the fidelity control at No. 3 position and the wave-band switch at MW (green spot, clockwise).

Voltages should be measured with a high-resistance meter with chassis as negative.

Valve	Anode Voltage (V)	Anode Current (mA)	Screen Voltage (V)	Screen Current (mA)
V1 FC4	210	2.0	90	4.5
	Oscillator			
V2 VP4B	210	6.5	210	1.5
V3 TDD4	140	1.5	—	—
V4 ACO42	275	42.0	—	—
V5 1W4/350	350†	—	—	350
T.I. TV4	30	0.1	—	—
	Target very low			

† Each anode, AC.

COMPONENTS AND VALUES

RESISTORS		Values (ohms)
R1†	V1 CG decoupling ...	1,250,000
R2	V1 fixed GB resistor ...	300
R3	1st IF transformer damping resistors ...	3,000
R4		
R5	V1 osc. CG resistor ...	100,000
R6	V1 HT feed resistor ...	20,000
R7	V2 CG decoupling ...	1,000,000
R8	V2 fixed GB resistor ...	300
R9	IF stopper ...	50,000
R10	V3 signal diode load ...	250,000
R11	T.I. CG decoupling ...	500,000
R12	T.I. control potential divider ...	1,000,000
R13		
R14*	Manual volume control ...	500,000
R15	V3 triode CG decoupling ...	2,000,000
R16	V3 triode anode load ...	50,000
R17	V3 triode GB and AVC delay HT potential divider ...	100,000
R18		
R19	V8 AVC diode load resistors ...	250,000
R20		
R21	...	500,000
R22*	Bass compensator ...	50,000
R23	V4 CG resistor ...	100,000
R24	V4 heater potentiometer ...	30
R25	V1-V3 HT feed resistor ...	4,000
R26	V4 GB potential divider ...	50,000
R27		
R28	V4 CG decoupling ...	100,000
R29	T.I. anode HT feed ...	30,000
	T.I. anode HT feed ...	2,000,000

* Ganged together with S18. † Made up of two resistors in series: 1,000,000 Ω and 250,000 Ω.

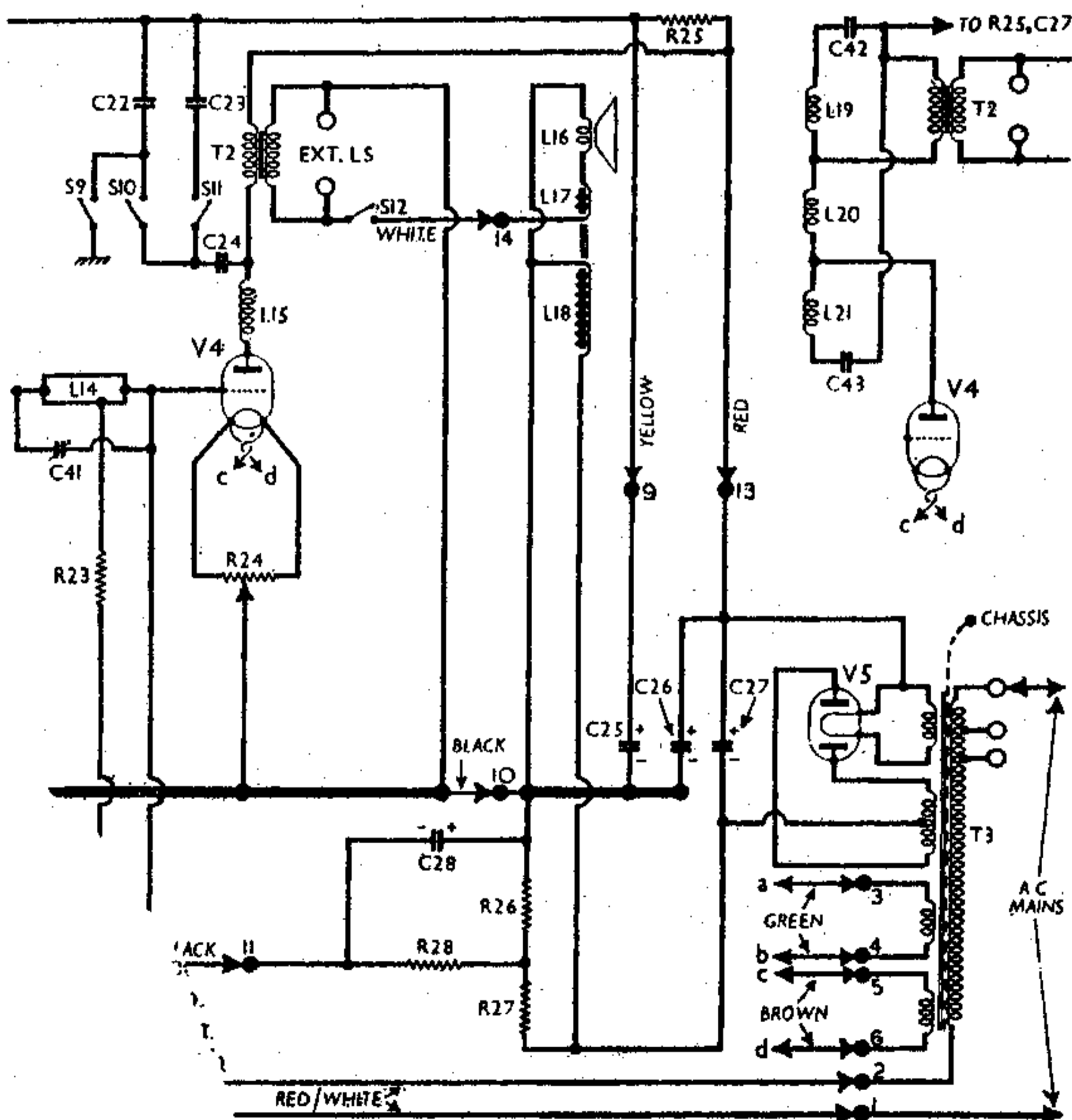

Circuit diagram of the Ekco AC97 AC super-het. The external connections to the L1-L5 unit are coded A to H to agree with the tag markings in the under - chassis view above. The connections between the receiver chassis and the power unit are numbered 1 to 14. The tags are similarly numbered in our illustration of the power unit overleaf. The colours of the lead-out wires from T1 are also marked. Inset at top right is a diagram of the low-pass filter used in later models. The rectangular block marked L14 represents the whistle rejector coil. The differences in the radiogram versions are explained overleaf.

CONDENSERS		Values (μF)
C1	Aerial MW coupling ...	0.0008
C2	V1 CG decoupling ...	0.1
C3	Part 1st IF trans. coupling ...	0.0003
C4	V1 cathode by-pass ...	0.1
C5	V1 osc. CG condenser ...	0.0001
C6	Osc. LW fixed tracker ...	0.0008
C7	V1 HT feed decoupling ...	0.1
C8	V2 CG decoupling ...	0.1
C9	V2 cathode by-pass ...	0.1
C10	IF by-pass condensers ...	0.00012
C11		0.00015
C12*	V3 cathode by-pass ...	25.0
C13	V2 CG decoupling ...	0.1
C14	T.I. CG decoupling ...	0.1
C15	HT circuit RF by-pass ...	0.1
C16	Coupling to V3 AVC diode ...	0.000015
C17	AF coupling to V3 triode ...	0.1
C18	V3 triode CG decoupling ...	0.5
C19	AF coupling to T1 ...	0.25
C20	Bass compensator ...	0.2
C21	V4 CG condenser ...	0.25
C22	Tone control condensers ...	0.05
C23		0.02
C24		0.25
C25*	HT smoothing condensers ...	4.0
C26*		8.0
C27*		8.0
C28*	V4 CG decoupling ...	4.0
C29†	Image suppressor ...	—
C30†	Band-pass pri. tuning ...	—
C31†	B-P pri. MW trimmer ...	—
C32†	Band-pass sec. tuning ...	—
C33†	B-P sec. MW trimmer ...	—
C34†	Oscillator circuit tuning ...	—
C35†	Osc. circ. MW trimmer ...	—
C36†	Osc. circ. LW tracker ...	—
C37†	1st IF trans. pri. tuning ...	—
C38†	1st IF trans. sec. tuning ...	—
C39†	2nd IF trans. pri. tuning ...	—
C40†	2nd IF trans. sec. tuning ...	—
C41†	9 kc/s rejector tuning ...	—

* Electrolytic. † Variable. ‡ Pre-set.

OTHER COMPONENTS		Approx. Values (ohms)
L1	Aerial LW coupling coil ...	40.0
L2	Band-pass pri. coils ...	2.5
L3		25.0
L4	Band-pass sec. coils ...	2.5
L5		25.0
L6	Osc. MW tuning coil ...	5.0
L7	Osc. LW tuning coil ...	10.0
L8	Oscillator reaction coils ...	5.0
L9		5.0
L10	1st IF trans. { Pri. ...	75.0
L11		Sec. ... 75.0
L12	2nd IF trans. { Pri. ...	75.0
L13		Sec. ... 75.0
L14	9 kc/s rejector coil ...	3,000.0†
L15	Low-pass filter choke ...	150.0
L16	Speaker speech coil ...	8.0
L17	Hum neutralising coil ...	0.1
L18	Speaker field coil ...	2,000.0
T1	Intervalve trans, total ...	1,600.0
T2	Output trans. { Pri. ...	300.0
		Sec. ... 0.4
		Pri., total ... 35.0
		V1-V3 heat. sec. ... 0.1
T3	Mains trans. { V4 heat. sec. ...	0.1
		Rect. heat. sec. ... 0.1
		HT sec., total ... 600.0
S1-S6	Waveband switches ...	—
S7-11	Fidelity control switches ...	—
S12	Int. speaker switch ...	—
S13	Mains switch, ganged R14, R22 ...	—
X, Y, Z	Mute tuning switch ...	—

† Measured across C41 terminals.

DISMANTLING THE SET

Removing Receiver Chassis.—Remove the three control knobs (recessed grub screws) from the front of the cabinet, and the waveband switch knob (screw inside cabinet) from the side; slacken the two set-screws (with lock-washers) holding the tuning indicator bracket to the scale assembly, drop the bracket and tighten screws; remove two screws holding the ends of the chassis to the front of the cabinet, and two similar screws holding chassis to the rear of the cabinet; withdraw the two scale lamps from their brackets at the top of the scale assembly. The chassis may now be withdrawn to the extent of the cable connecting it to the power unit at the bottom of the cabinet. To free the chassis entirely, unsolder the tags on the connecting strip at the end of the cable from those on the power unit. As both rows are rigidly mounted, the tags must be separated as they are unsoldered one at a time by inserting a strip of aluminium or other suitable material between them while the solder is hot.

Removing Power Unit.—Remove the cheese-head screw holding the vertical strut on the unit deck to the speaker magnet; remove four screws (with lock-washers) holding the unit to the bottom of the cabinet, when the unit may be withdrawn to the extent of the speaker leads, which is sufficient for most purposes. To free chassis entirely, unsolder from the tags at the rear of the unit the three leads connecting it to the speaker. When replacing, connect the speaker leads as follows, using the tag numbers as shown in our illustration of the unit: blue lead, tag 7; yellow lead, tag 12; white lead, tag 14.

Removing Speaker.—First remove the receiver chassis and power unit as already described, then remove the nuts (with lock-nuts and washers) holding the speaker to the sub-baffle. When replacing, the connecting panel should be at the bottom, and if the leads have been unsoldered they should be connected as follows, numbering the tags from left to right: 1 and 2 (joined together), yellow (or black); 3, white; 4, no external connection; 5, blue.

GENERAL NOTES

Switches.—S1-S6 are the waveband switches, ganged in a single rotary unit contained in the L1-L5 coil unit assembly beneath the chassis. It cannot be seen unless the internal assembly is removed from its screen as described under "Coils," but its position is approximately indicated in our under-chassis view, where the arrow pointing to it shows the direction in which it is viewed in the upper diagram in col. 3. In the MW (clockwise) position of the control S1, S3, S5 and S6 close, while S2, S4 open. In the LW position, S2, S4 close, and the others open.

S7-S11 are the fidelity and tone control switches, ganged in a three-position rotary unit mounted at the front of the chassis deck. In the high-fidelity position (fully clockwise) of the control, marked 1 on the cabinet, all the switches except S9 are open, and the band-width of the first IF transformer is broad; in position 2, S7, S8 and S10 close, connecting C22, C24 across T2 primary. In

position 3 (fully anti-clockwise), S11 closes, and S10 opens. S7 and S8 remain closed.

A detailed diagram of the S7-S11 unit, drawn as seen from the rear of the chassis deck, appears in col. 3 (lower diagram). S12 is the internal speaker muting switch, a screw-type unit mounted at the rear of the chassis on the external speaker connecting panel. S13 is the QMB mains switch, ganged with the volume control unit R14, R22.

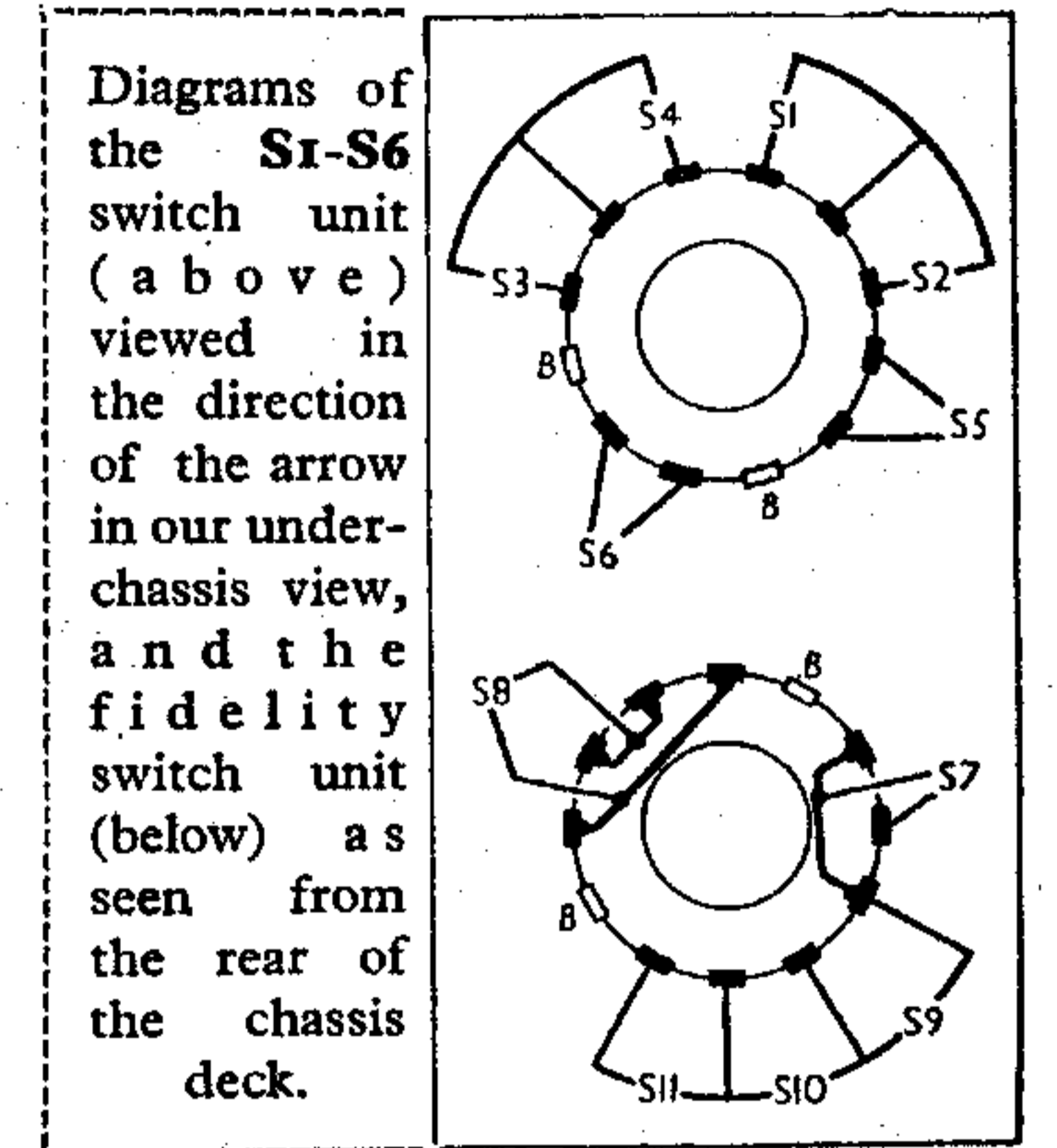

The silent tuning switch consists of three contacts assembled like a jack switch. The switch is mounted on the front of the gang unit, just behind the tuning control spindle. Normally the contacts X, Y, Z are open, but when the tuning control is pressed, first X makes contact to Y, then Y makes contact to Z, muting the receiver.

Coils.—All the band-pass circuit coils are in an enclosed screening unit, mounted on a bracket beneath the chassis, and to obtain access to them, or to the waveband switch unit that is enclosed with them, it is necessary to remove them from the case. This is quite a simple matter, but it involves unsoldering from the tags on the connecting panel at one end of the unit the leads connecting it to the rest of the chassis.

When replacing the unit, reference should be made to the circuit diagram, where the connections are all indicated by letters A to H, and the lead colours shown. The tags associated with the letters are identified in our under-chassis view. It should be noted that the oscillator circuit switch S6 is connected to tags B and F. The remaining six tags are all connected to the aerial and band-pass circuits.

The oscillator coils L6-L9 are in a screened unit on the chassis deck with C5. The IF transformers L10, L11 and L12, L13 are in two further screened units on the chassis deck, and each contains several other components.

L14 and C41 form a 9 kc/s whistle rejector, mounted in a single assembly on the rear chassis member, so that C41 adjustment is accessible from the rear. The choke has six contacts, but as no information is available as to its internal connections it is shown as a block in our circuit diagram. If trouble is suspected in

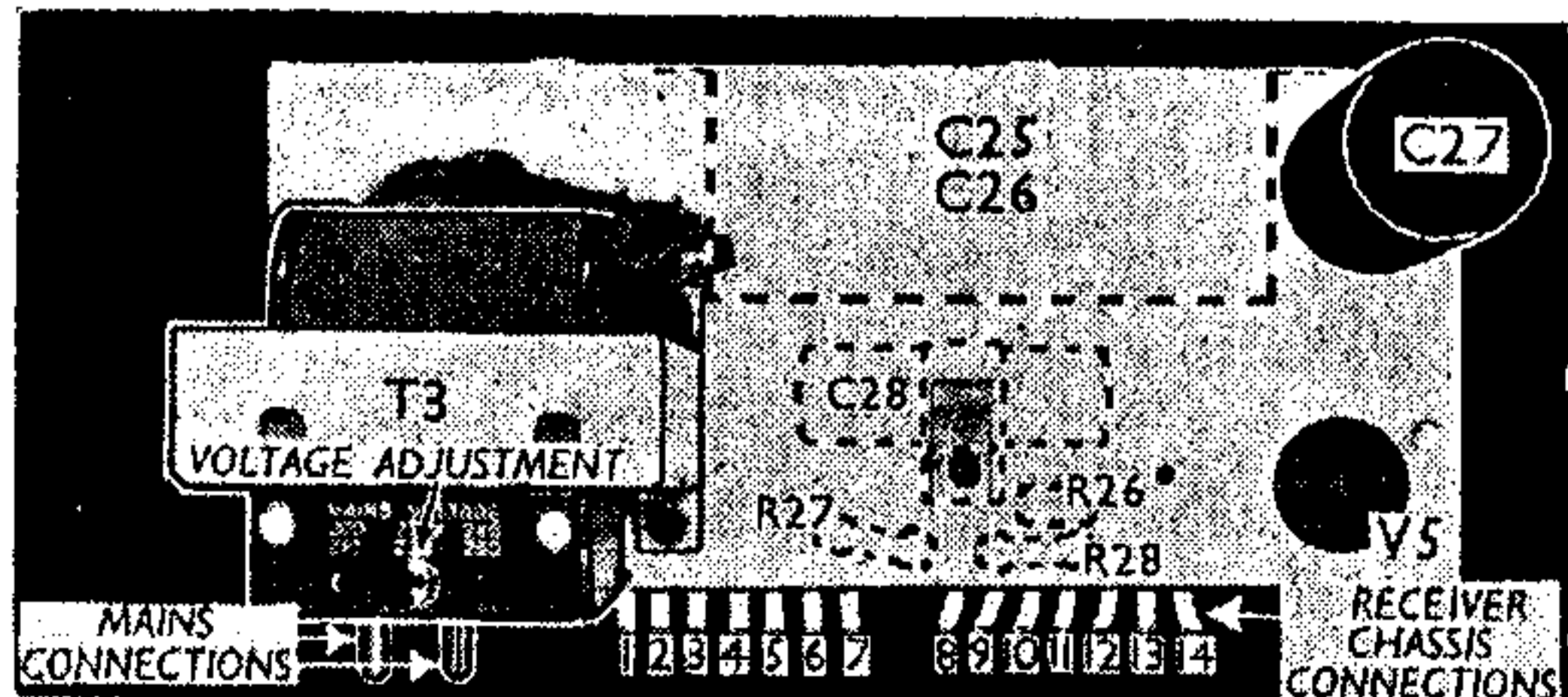

Plan view of the power unit, showing the connecting tags to the main chassis. The positions of the components below deck are indicated. The speaker is connected to this unit.

coil, the connection to C41 should be short-circuited, cutting out the rejector, as it serves no useful purpose to-day, and it was fitted only on early models. R23 is connected to one of the tappings.

Scale Lamps.—These are two Osram MES type lamps, rated at 6.2 V, 0.3 A. They are mounted on two slip-on brackets fixed to the front of the cabinet.

External Speaker.—Two sockets are provided at the rear of the chassis for a low-impedance (about 15 Ω) external speaker. Switch S12 permits the internal speaker to be muted.

Condensers C25, C26, C27.—These are three electrolytics mounted on the power unit. C25 and C26 are in a single unit beneath the deck. The red lead is the positive of C26 (8 μF), and the yellow that of C25 (4 μF). The black lead is the common negative connection.

C27 is a wet electrolytic in a tubular container mounted on the deck of the unit, but isolated from it. It is rated at 8 μF, 500 V working, 525 V peak.

Chassis Divergencies.—Several versions of the main receiver chassis were made. Our circuit diagram is based entirely on our chassis, which was an early model. In later models, L15 and the 9 kc/s whistle rejector L14, C41 are omitted. A modified low-pass filter is then fitted, of more elaborate design, in place of L15. The modified circuit is shown inset in the top right-hand corner of the circuit diagram overleaf. The DC resistance values of the coils are: L19, 50 Ω; L20, 70 Ω; L21, 50 Ω. The condenser values are: C42, C43, both 0.01 μF.

The coil unit is mounted vertically on the chassis deck, approximately in the position shown in our illustration for C24. The two condensers are on top of T2, where we show L15.

The tone control circuit S10, S11, C22, C23 is also different in such models, being connected between V3 triode control grid and chassis instead of across T2 primary. The values of the condensers are altered to 0.0005 μF (C22) and 0.0015 μF (C23). S9 and C24 are not referred to in the makers' diagram, which shows the later model.

Other differences in the makers' diagram occur in the values of some resistors. R18 is 600 Ω, and R19 is 2,000 Ω, instead of being 1,000 Ω each; while R26 is 30,000 Ω, and R27 and R28 are both 100,000 Ω instead of 50,000 Ω, 100,000 Ω and 30,000 Ω respectively as in our chassis. The modified values will be found in later versions of the receiver.

Inter-chassis Connections.—The connections between the main receiver chassis and the power unit run via an eleven-way cable which is attached to the chassis and terminated at a rigid strip of connecting tags. These tags in turn correspond with eleven of the fourteen tags on the rear of the power unit, numbered in our illustration from 1 to 14. Numbers 7, 8 and 12 are omitted from the cable strip.

The points of interconnection are indicated in the circuit diagram, where the connection numbers and cable lead colours are shown. The three speaker connections are taken from the power unit. The junction of L16 and L18

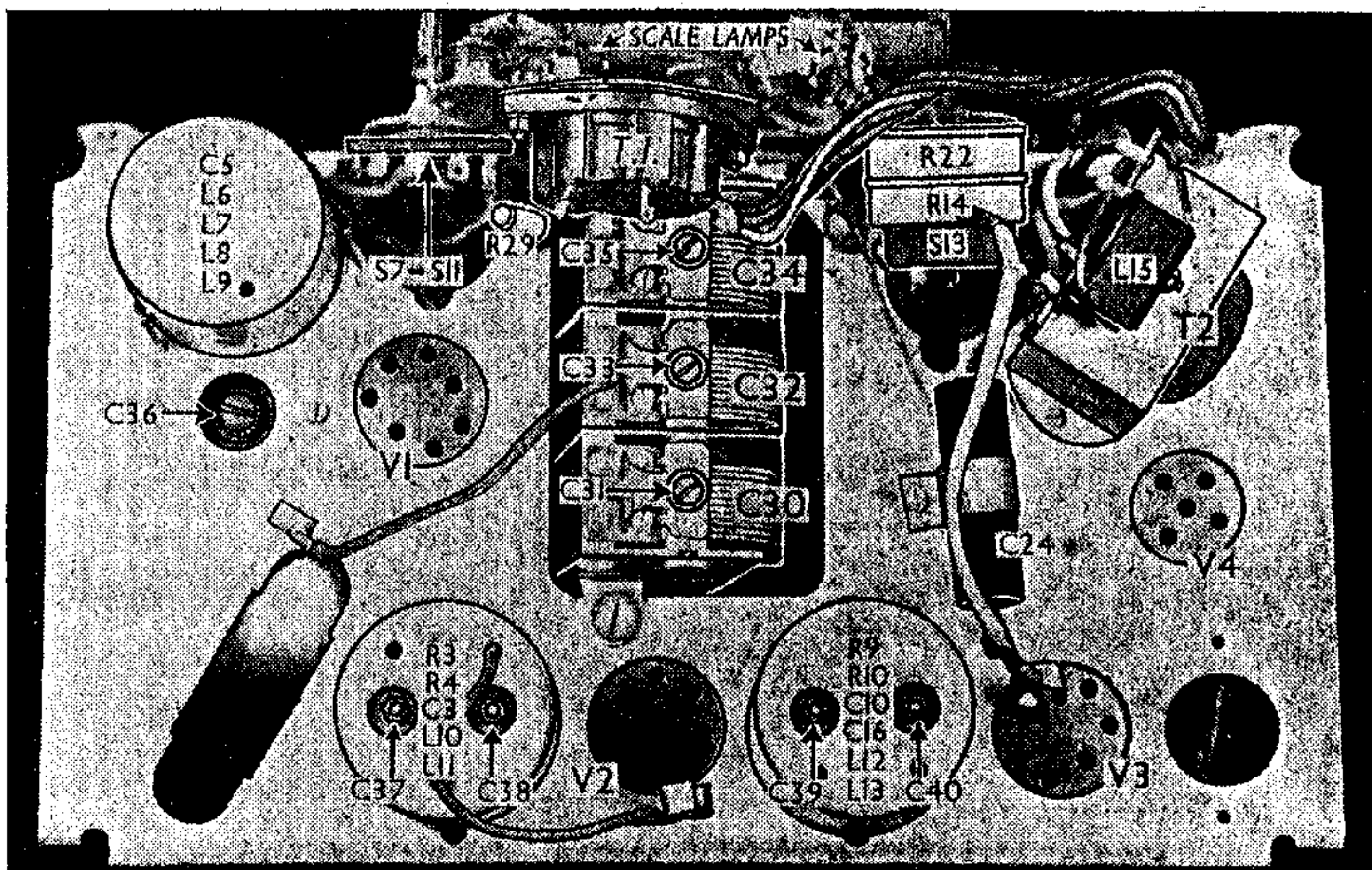

Plan view of the chassis. In later models L15 may be omitted, and a low-pass filter coil unit may take the place occupied in this illustration by C24.

(yellow or black) goes to tag 12 (which is joined internally to tag 10); the bottom of L18 (blue) goes to tag 7; and the bottom of L17 (white) goes to tag 14.

These tags form an excellent method of access to voltage points for quick checks on the condition of the HT circuit, as they are readily accessible upon removing the back cover from the cabinet.

RADIOGRAM MODIFICATIONS

The differences in the chassis used in the radiogram RG97 and autoradiogram ARG107 as compared with that in the table model are concerned with the method of introducing the pick-up.

The affected part of the circuit is redrawn and shown in the diagram at foot of col. 6, where it will be seen that on gram the pick-up is fed via S14 to the control grid of the tuning indicator. The output of the triode section is then taken from R31 via S16, C17 and R14 to V3 triode.

At the same time, S18 closes and takes the AVC circuit via R37 to R28 (contact Y of the silent tuning switch), biasing the AVC diode and V1, V2 negatively. As S15, S17 also open, radio is effectively muted.

On radio, the circuit reverts almost to the same arrangement as in the table model. The differences are that R29 is split into three elements, R30, R31, R32; R18, R19 are split into three, R34, R35, R36; C14 is now between control grid and cathode of T.I.; and switches S15, S17 (which close on radio) are included in the circuit. The change-over switch is an additional unit, and its control knob is situated on the control panel.

Those components which bear the same numbers as in the AC97 diagram overleaf have the same values. The values of the added resistors are given in the table in col. 6. C42 is 0.5 μF.

CIRCUIT ALIGNMENT

IF Stages.—Connect signal generator leads to socket E and, via a 0.02 μF condenser, to the control grid (top cap) of V1, leaving the existing connector in place. Switch fidelity control to its centre position and the volume control to maximum. Feed in a 126.5 kc/s (2,372 m) signal, and adjust C37, C39, then C38, C40, for maximum output. Repeat these adjustments, keeping signal input low.

RF and Oscillator Stages.—Transfer signal generator leads to A and E sockets via a suitable dummy aerial.

MW.—Switch set to MW, tune to 200 m on scale, feed in a 200 m (1,500 kc/s) signal, fully unscrew C35,

then screw it up slowly until the first peak is reached. Now adjust C35 for maximum output. Feed in a 250 m (1,200 kc/s signal, tune it in, and adjust C33, then C31, for maximum output.

LW.—Switch set to LW, tune to 1,700m on scale, feed in a 1,700 m (170.6 kc/s) signal, and adjust C36 for maximum output while rocking the gang for optimum results.

Image Suppressor.—As the power and frequency dispositions of transmitters have undergone various changes since the receiver was marketed, the original instructions for image suppression no longer apply.

If image interference is experienced, however, it may be minimised by tuning to the position at which it is found and adjusting C29 for minimum interference, using the speaker as an indicator.

Added Resistors in RG Models

RES.	Values (ohms)	RES.	Values (ohms)
R30	1,000,000	R34	1,000
R31	250,000	R35	400
R32	1,000,000	R36	600
R33	15,000	R37	1,000,000

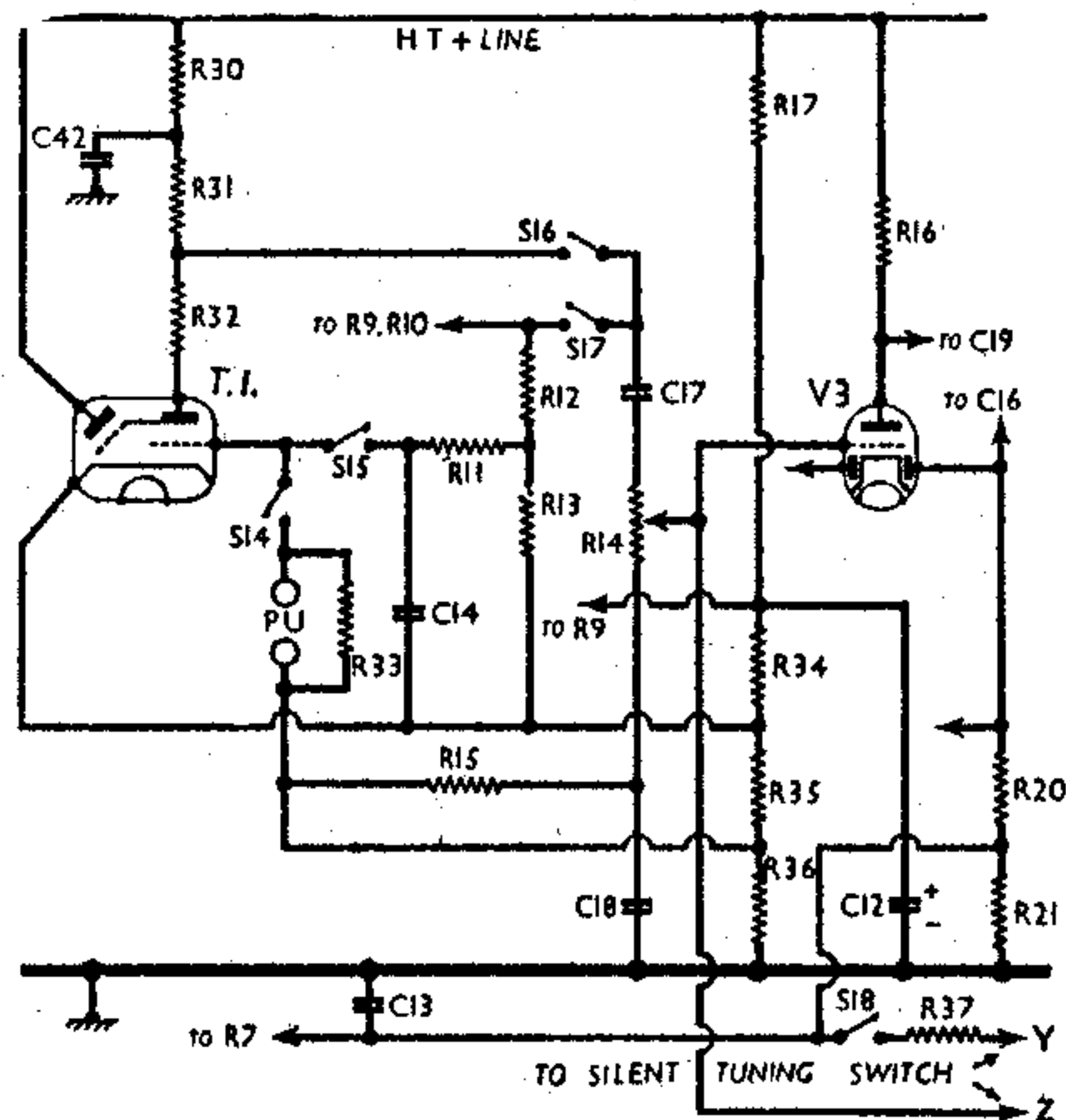

Diagram showing the circuit changes in the radiogram models. The tuning indicator is used as a pick-up amplifier.