

DUCRETET
PHONOMODULA 6L.
1927/1929

Ned. Ver. v. Historie v/d Radio

LE PHONO MODULA
6 Lampes

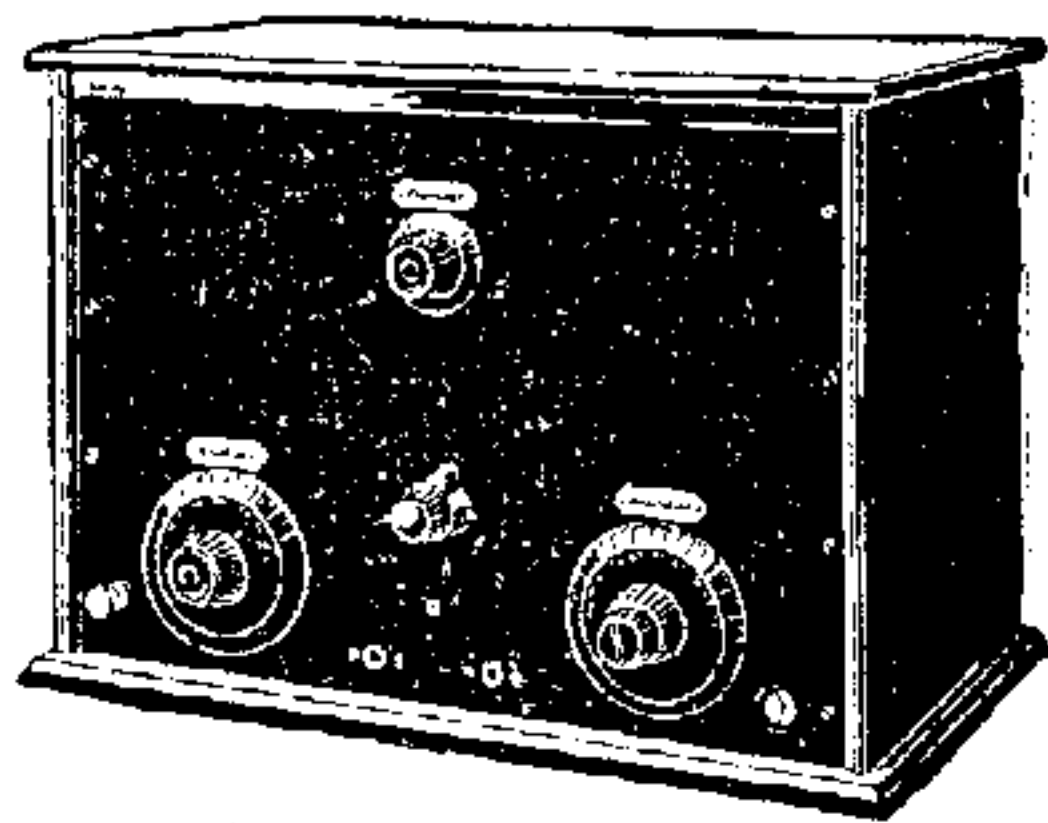
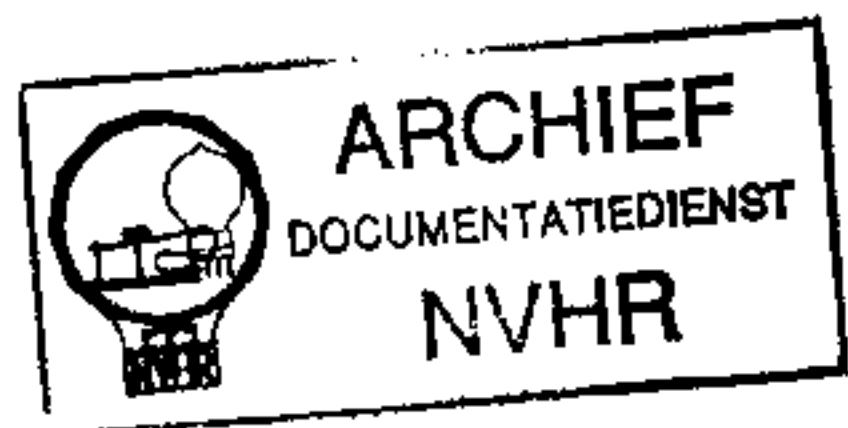

Même coffret que le Supermodula 5L. de 1927

PHONOMODULA 6L DUCRETET / PM6

(RM6 PHONO)

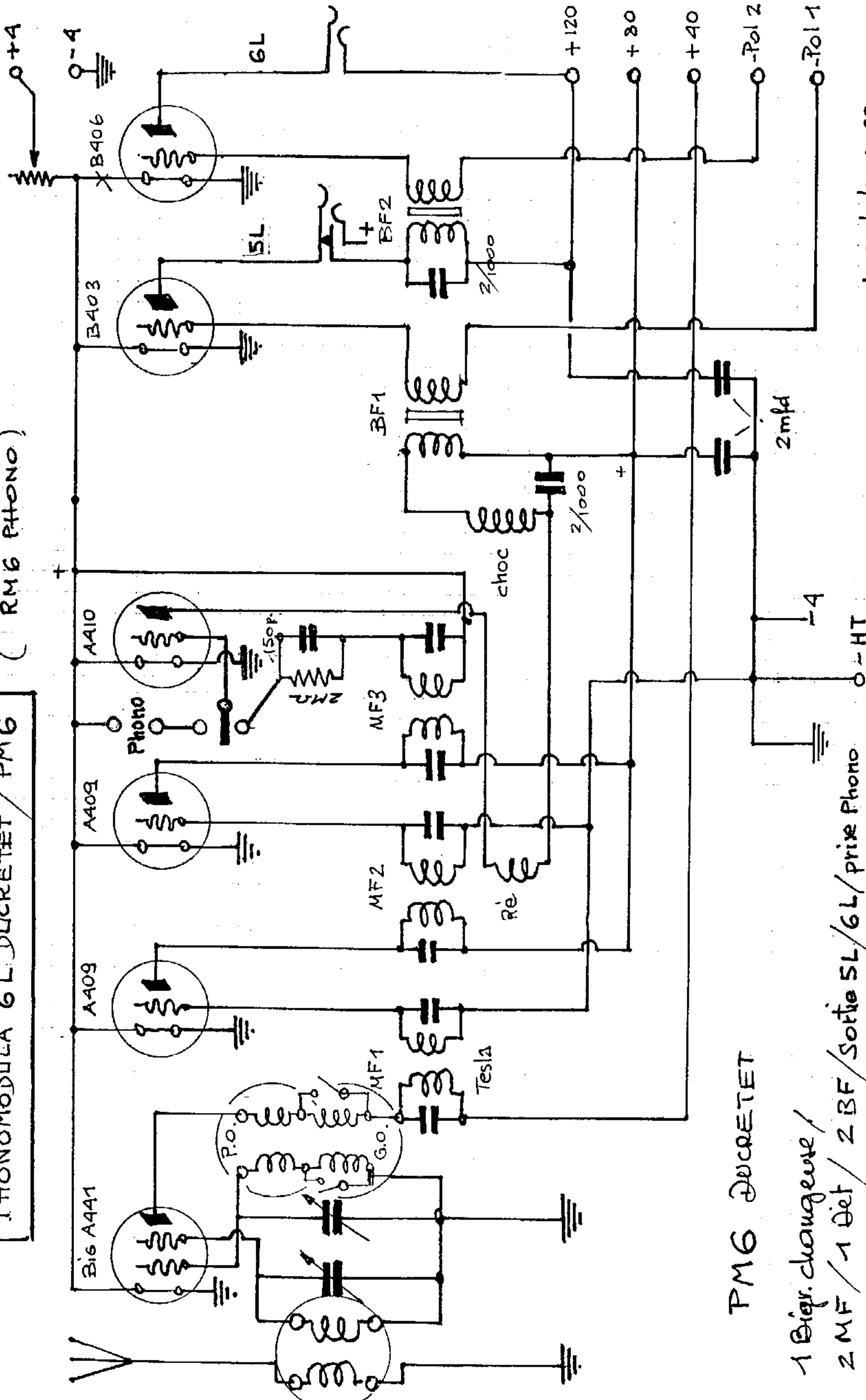

PM6 DUCRETET

1 Bigr. changeuse /
 2 MF / 1 Det / 2 BF / Sortie 6L / 6L / prise Phono
 les commutateurs n'ont pas été dessinés / détail dans le schéma de câblage

-H. Corbet 1.98

PHONOMODULA 6L DUCRETET/PM6/RMG PHONO. (N°4)

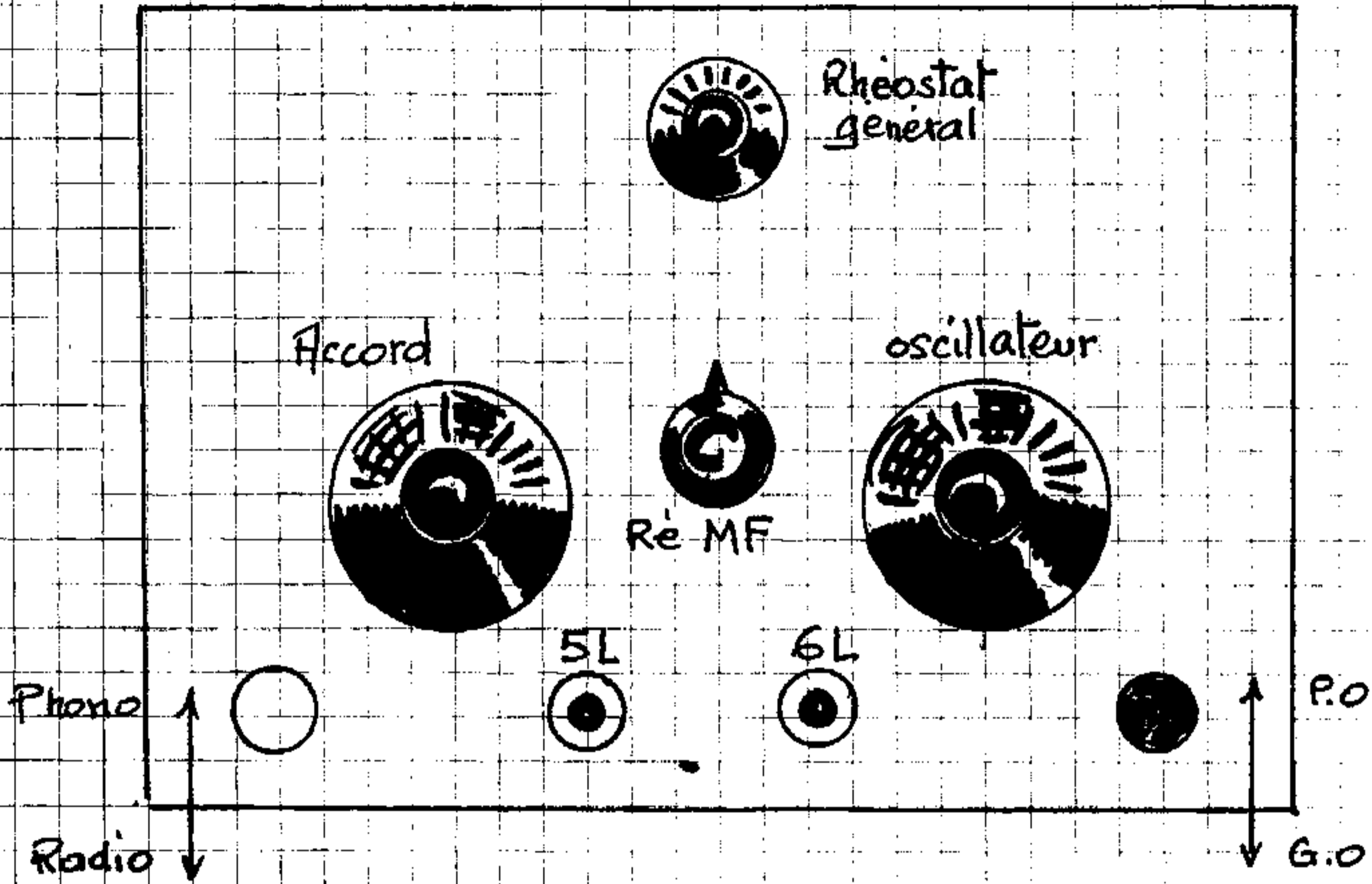

ALIMENTATION

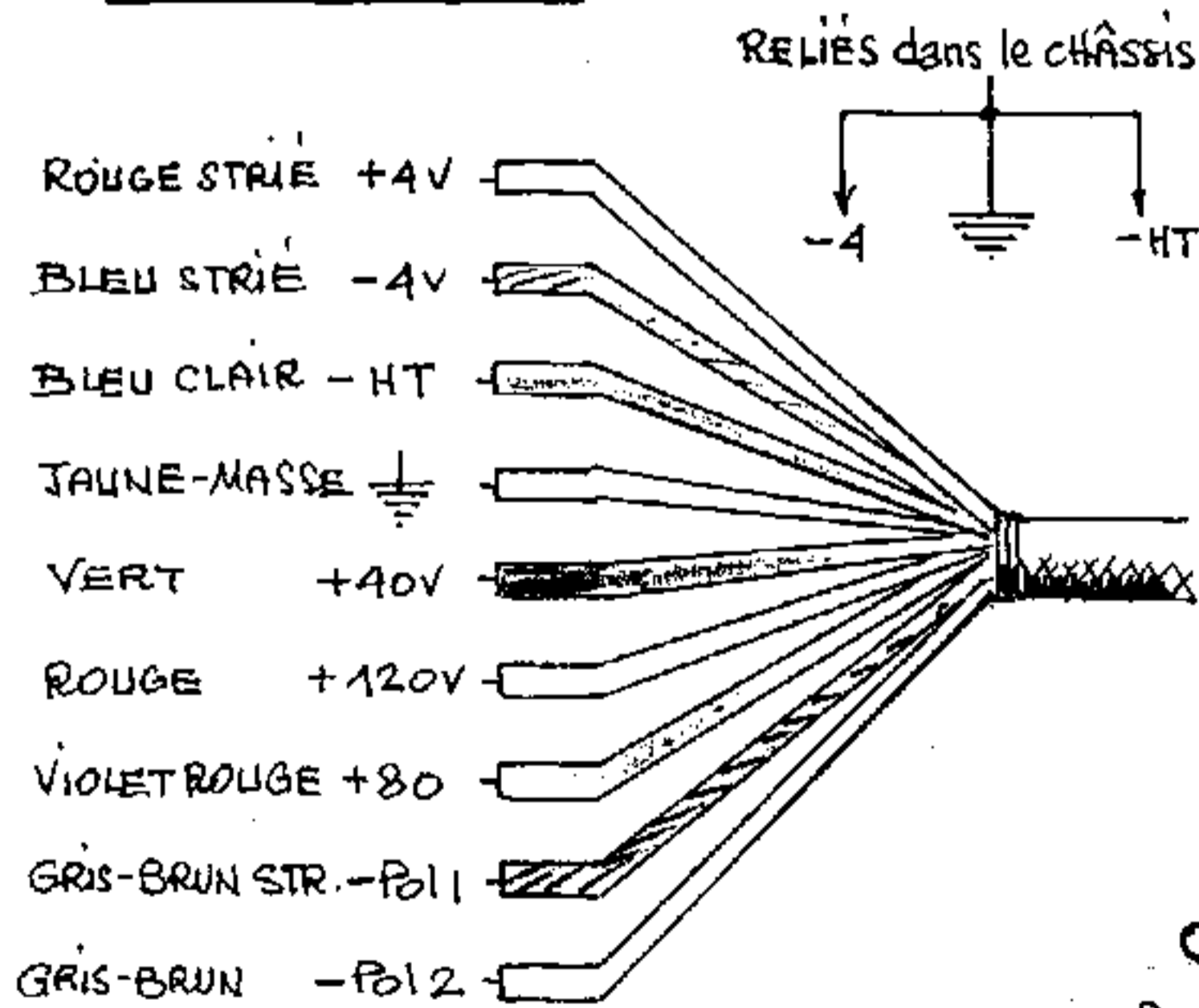

on peut relier le +80 et le +120 lors d'une seule source +HT, ainsi que les 2 (-P01).

oscillatrice G.O. intérieure avec commutation

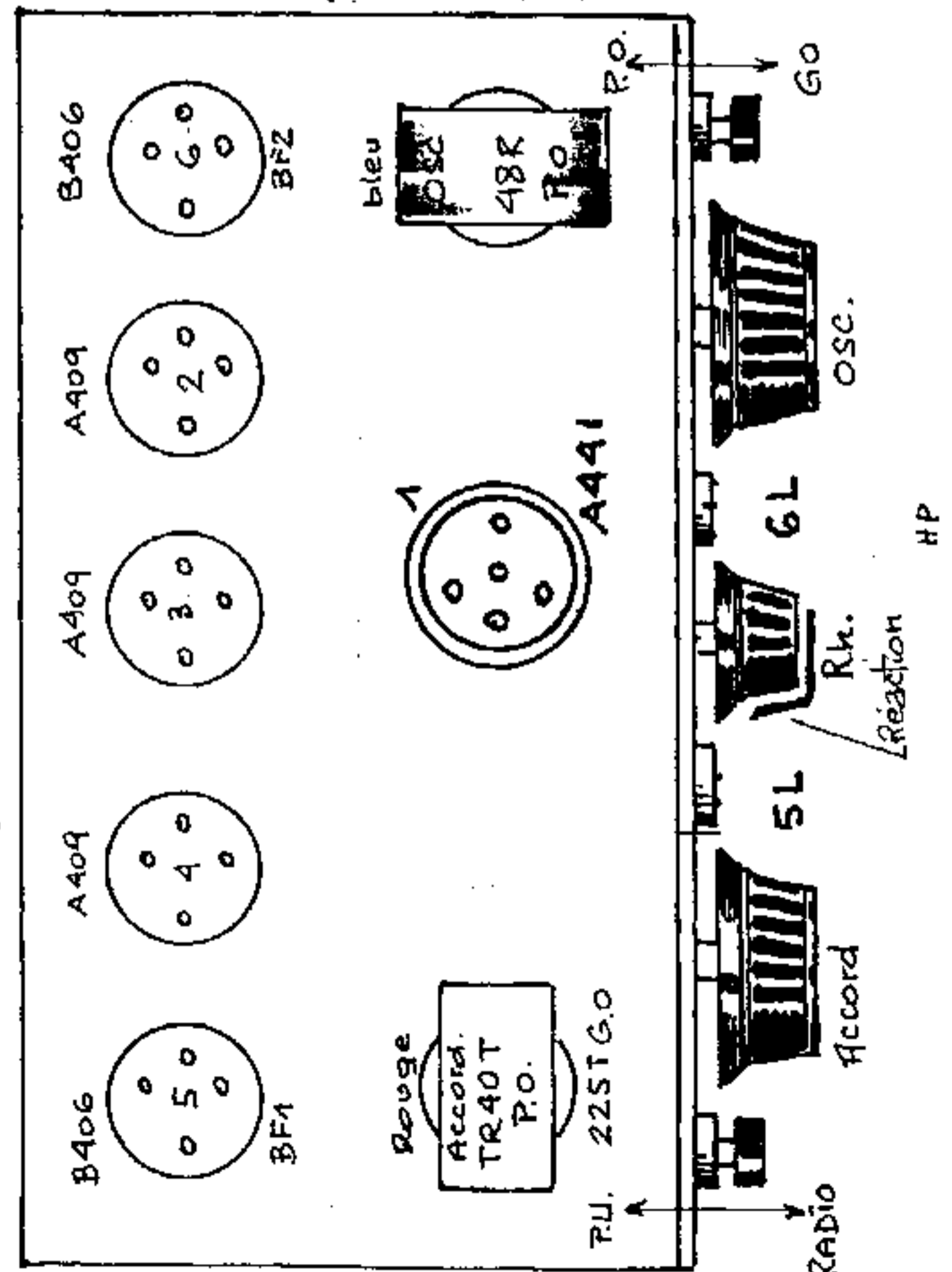
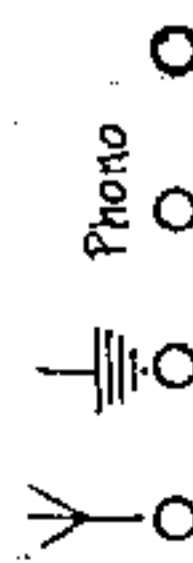

PHONOMODULA 6L / PM6

RM6 PHONO

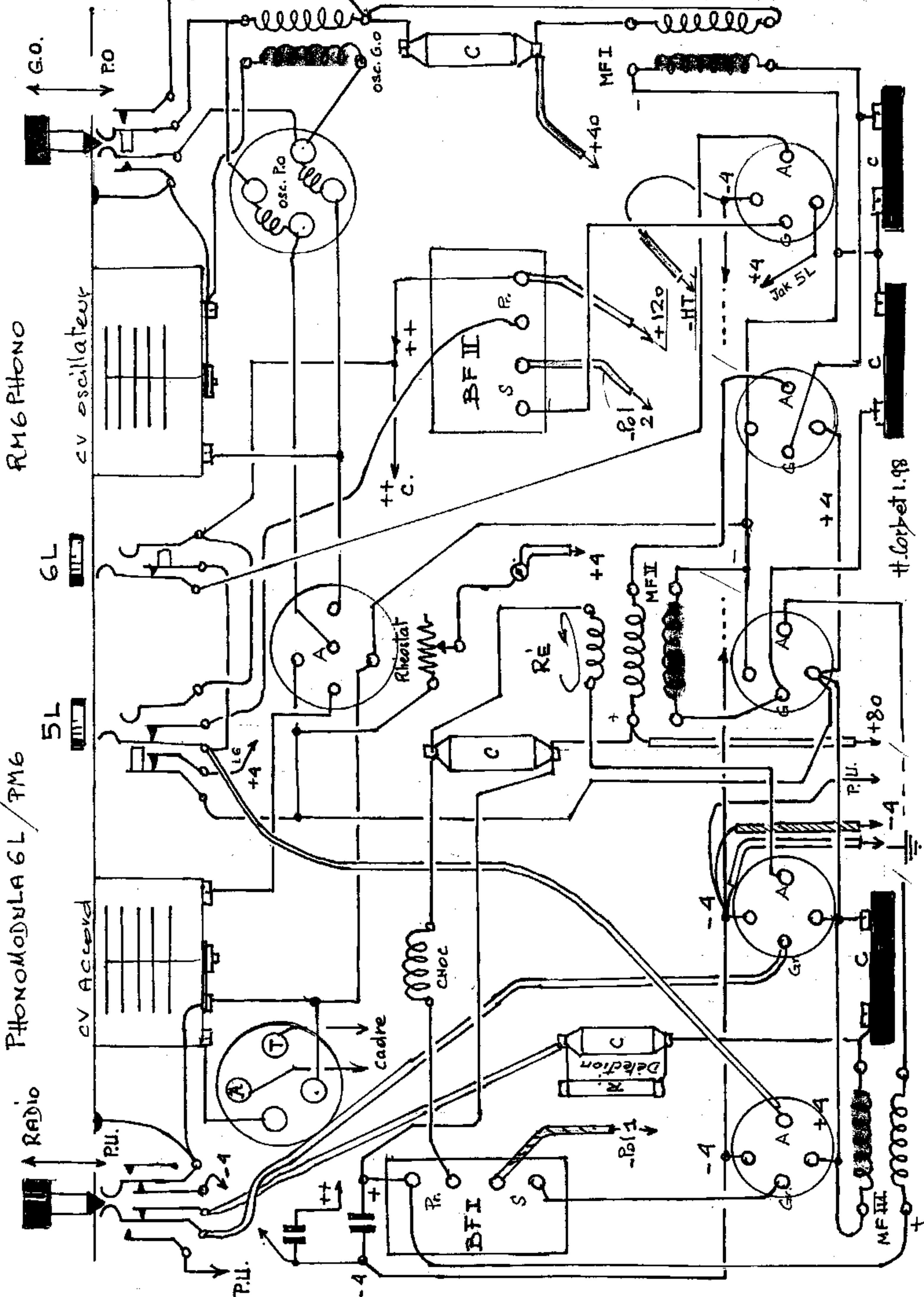

Corbet 1.98