

DECCA AW10

PRESS-BUTTON AC SUPERHET

Ned. Ver. v. Historie v/d Radio

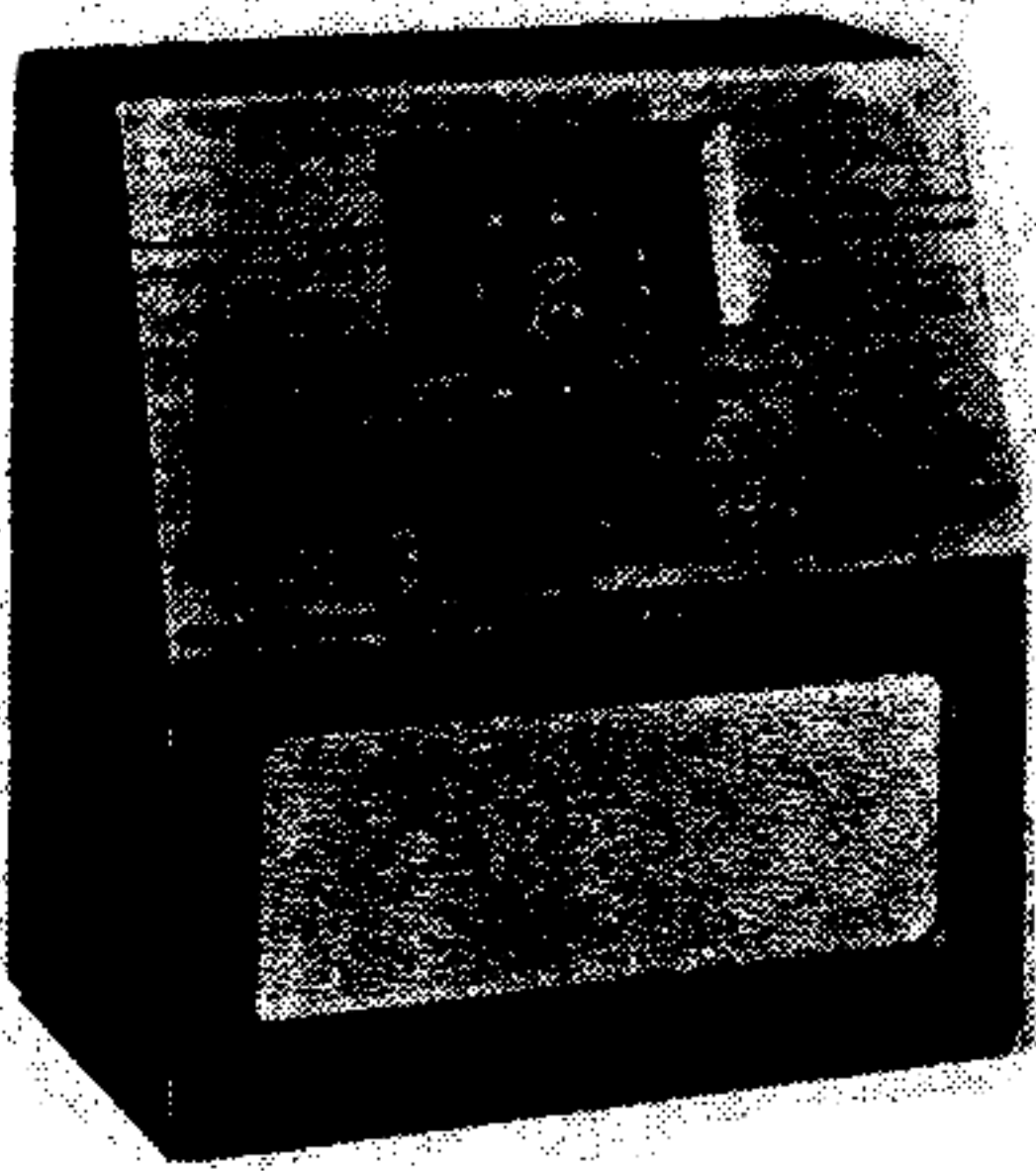
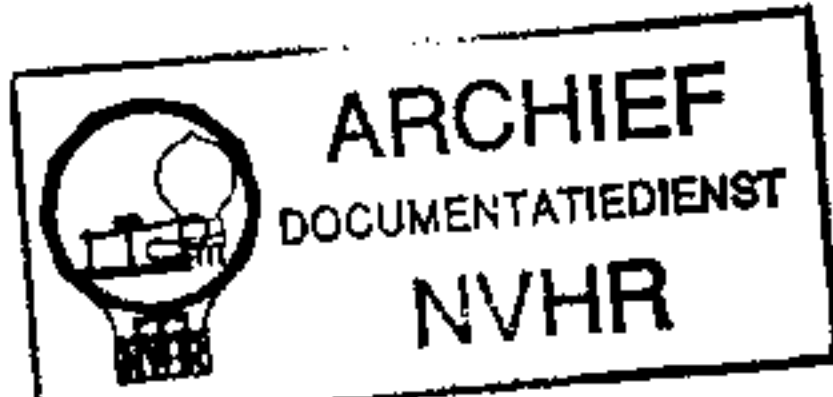

PRESS - BUTTON tuning of the mechanical type for eight stations (including a MW and LW station on each of two buttons) is provided in the Decca AW 10 receiver.

The receiver is a 5-valve (plus rectifier) 3-band superhet, suitable for operation from 200-250 V, 50-60 C/S mains.

The short-wave range is 16-50 m., and provision is made for the connection of a gramophone pick-up and a high impedance external speaker. Two beam tetrode valves are connected in parallel to feed the two internal loudspeakers,

which are also connected in parallel.

In connection with the press-button unit, a magnetic relay is fitted to eliminate the manual friction drive, so that quite a light pressure on the buttons is sufficient to turn the gang. The operation of the relay, which acts automatically, is described in *Circuit Description* and *General Notes*.

Release date: August, 1939.

CIRCUIT DESCRIPTION

Aerial input is via coupling condenser C2 and L2 (SW), and L3 (MW and LW) to single tuned circuits L4, C33 (SW), L5, C33 (LW) or L6, C33 (MW).

Coupling on MW is quite straightforward from L3, while L5 is short-circuited by switch S4; but on LW, coupling to L5 is via L3, L6 and C3, while S2 is closed.

First valve (V1, Mullard metallised TH62) is a triode hexode operating as frequency changer with internal coupling. Triode oscillator grid coils L7 (SW), L8 (LW) and L9 (MW) are tuned by C34; parallel trimming by C35 (SW), C11, C36 (LW) and C37 (MW); series tracking by C8 (SW), C9 (LW) and C10 (MW). Reaction by anode coils L10 (via stabilising resistance R6, SW) and L11 (MW and LW).

Second valve (V2, Brimar 6U7G) is a

variable-mu RF pentode operating as intermediate frequency amplifier with tuned-primary tuned-secondary transformer couplings C38, L12, L13, C39 and C40, L14, L15, C41.

Intermediate frequency 465 KC/S.

Diode second detector is part of double diode triode valve (V3, Mullard 6Q7G). Audio frequency component in rectified output is developed across load resistance R13 and passed via IF stopper resistance R12, AF coupling condenser C18 and manual volume control R14 to CG of triode section, which operates as audio frequency amplifier. IF filtering by R12, C17 and C19. Provision for connection of gramophone pick-up by sockets directly across R14.

Control potential to operate the cathode ray tuning indicator (T.I., Mullard EM4), to whose control grid it is applied via decoupling circuit R11 and C16, is obtained from junction of R12 and R13. The cathode circuit of the tuning indicator, to which the CG resistance R25 is returned, is returned to V3 cathode circuit.

Second diode of V3, fed from tapping on L15 via coupling condenser C21, provides DC potential, which is developed across load resistance R18 and fed back through decoupling circuits as

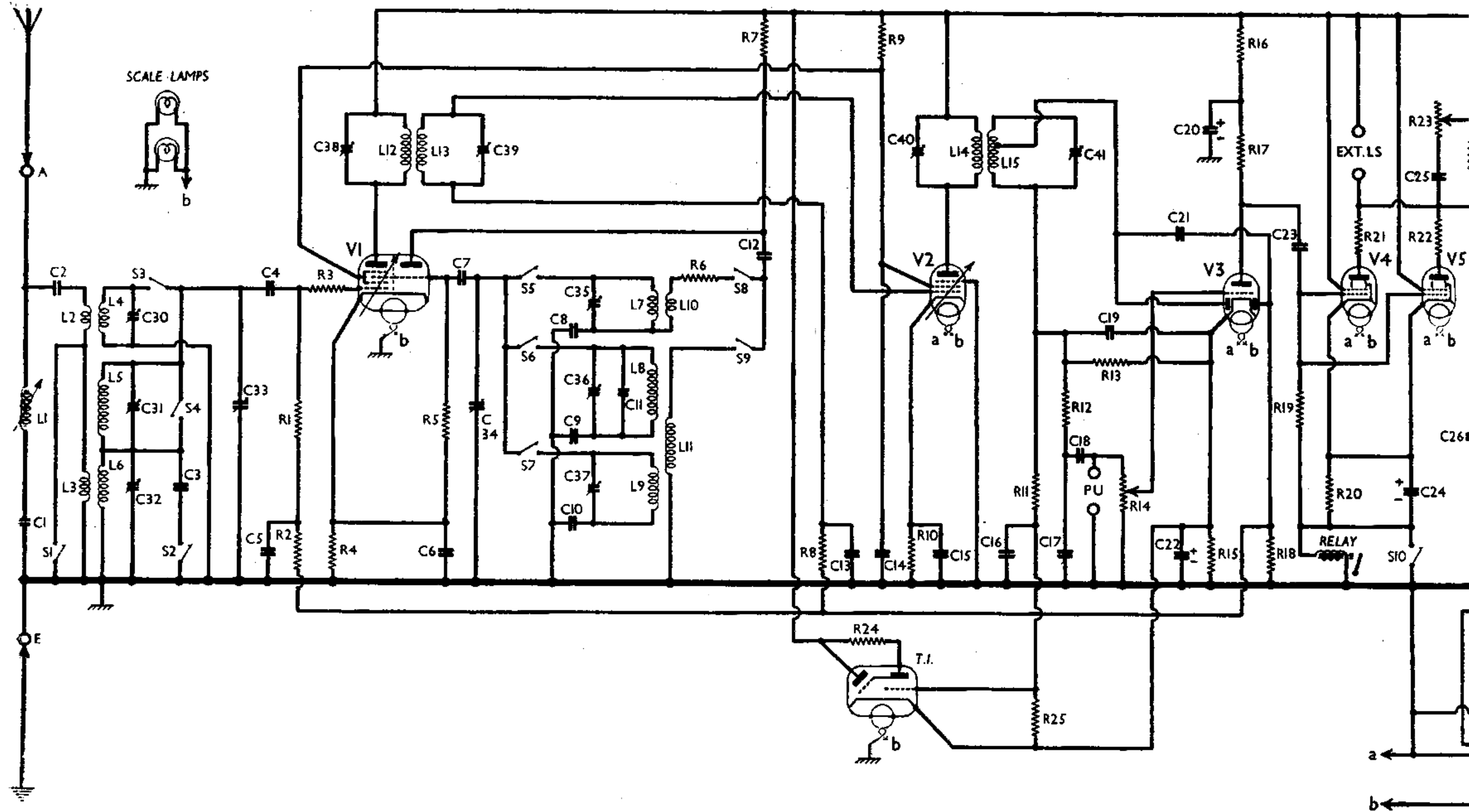

Under-chassis view. A diagram of the S1-S9 switch unit is given overleaf. Most of the trimmers (except those of the IF transformers) are indicated. The core of L1, the IF filter coil, is adjusted through a hole in the rear of the chassis

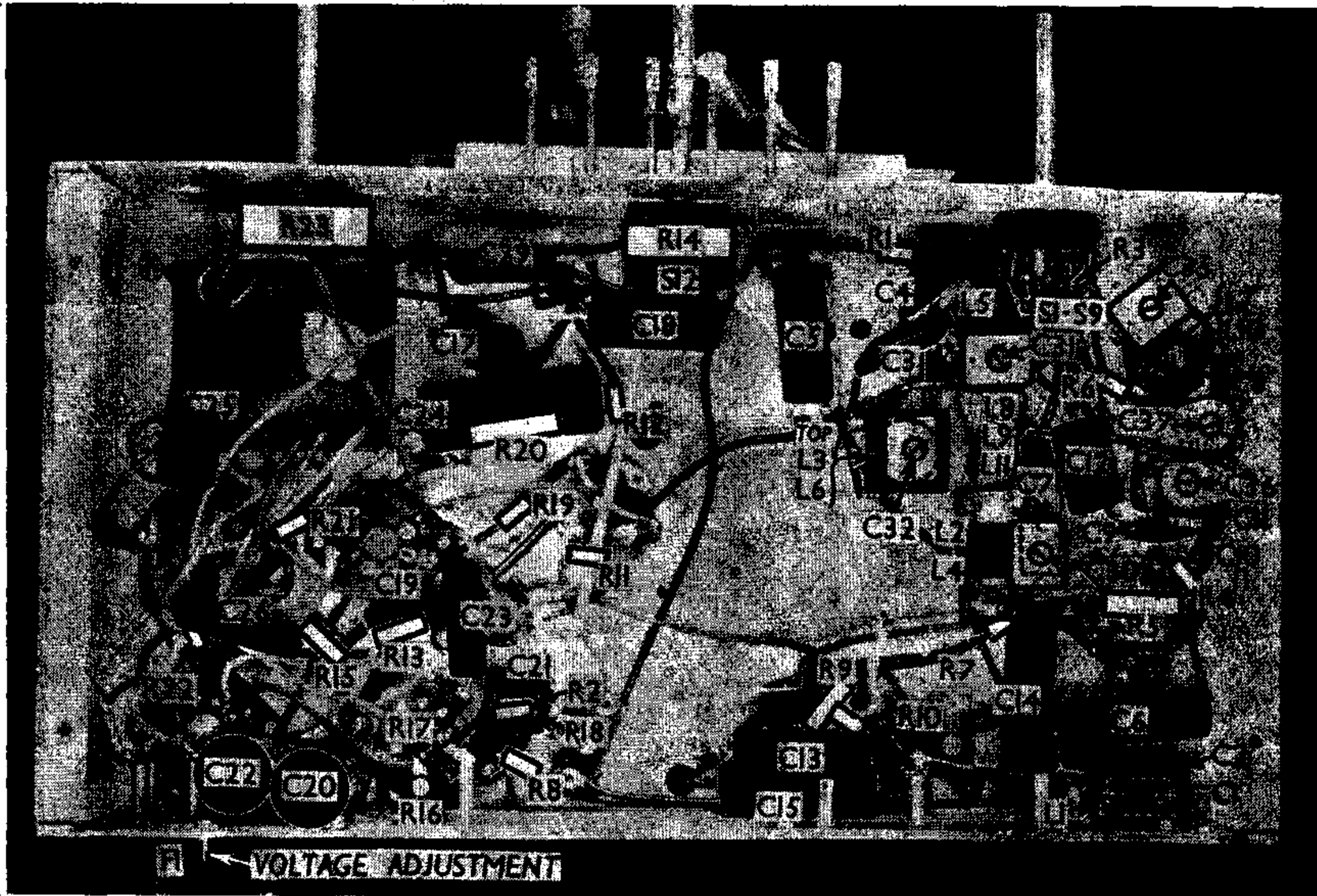

GB to FC and IF valves, giving automatic volume control. Delay voltage is obtained from drop along R15 in V3 cathode lead to chassis.

Resistance-capacity coupling by R17, C23 and R19 between V3 triode and parallel connected two-valve output stage which comprises two beam tetrode valves (V4, V5, Mullard 6V6G's). Provision for connection of high impedance external speaker between anodes (via stabilising resistances R21 and R22) and HT positive line. Variable tone control by R23 and C25 in anodes circuit. Fixed tone correction by C26, also in anodes circuit, but returned directly to chassis.

The speech coils L16 and L17 of the two internal speakers are connected in parallel across

the single internal speaker input transformer T1.

The common V4, V5 cathode biasing components R20 and C24, together with the common CG resistance R19, are normally connected to chassis via switch S10; but this switch, with switch S11, forms a leaf-type single-pole change-over switch unit which is associated with the mechanical press-button unit. When one of the buttons is pressed, S11 closes to mute the speakers, and S10 opens, so that the cathode current of V4 and V5 flows to chassis through the magnetic relay, whose armature is thus attracted. The application of this device is thenceforth entirely mechanical, and is dealt with under *General Notes*.

HT current is supplied by IHC full-wave rectifying valve (V6, Brimar 5Z4G). Smoothing is effected by iron-cored choke L18 and dry electrolytic condensers C27 and C28. Mains RF filtering by C29. Fuse F1 affords the input circuit protection against damage in case of accidental short-circuit, while its mounting acts as the voltage adjustment plug.

DISMANTLING THE SET

Before the chassis can be removed, it will be necessary to remove the speakers, though some measure of access may be gained to it through the opening in the chassis supporting shelf.

Removing Speakers.—Unsolder the speaker leads and remove the eight nuts (with lock washers) holding the speakers to the sub-baffle.

When replacing, see that the smoothing choke on the left-hand speaker faces the input transformer on the right-hand speaker when the speakers are viewed from the back of the cabinet, and connect the leads as follows, numbering the tags on the input transformer from top

to bottom: 1, black lead with white tracer from left-hand speaker together with black lead from two-core cable; 2, black lead from three-core cable; 3, blue lead from three-core cable together with upper lead from smoothing choke on left-hand speaker; 4, red lead from three-core cable together with lower lead from smoothing choke on left-hand speaker; 5, red lead from two-core cable together with other black lead with white tracer from left-hand speaker.

Removing Chassis.—Remove the four control knobs (recessed grub screws), the six press buttons (pull off), and the four bolts (with claw washers) holding the chassis to its supporting shelf. When replacing, do not forget to place a felt washer between each of the control knobs and the cabinet, except in the case of the tuning control knob.

COMPONENTS AND VALUES

| RESISTANCES | | Values (ohms) |
|-------------|-------------------------------------------|---------------|
| R1 | V1 hexode CG resistance ... | 500,000 |
| R2 | V1 hexode CG decoupling ... | 500,000 |
| R3 | V1 hexode grid stopper ... | 40 |
| R4 | V1 fixed GB resistance ... | 250 |
| R5 | V1 osc. CG resistance ... | 50,000 |
| R6 | Osc. reaction SW damping... .. | 70 |
| R7 | V1 osc. anode HT feed ... | 35,000 |
| R8 | V2 CG decoupling ... | 500,000 |
| R9 | V1, V2 SG's HT feed... .. | 35,000 |
| R10 | V2 fixed GB resistance ... | 250 |
| R11 | T.I. CG decoupling ... | 1,000,000 |
| R12 | IF stopper ... | 70,000 |
| R13 | V3 signal diode load ... | 300,000 |
| R14 | Manual volume control ... | 500,000 |
| R15 | V3 triode GB and AVC delay resistance ... | 3,000 |
| R16 | V3 triode anode decoupling ... | 25,000 |
| R17 | V3 triode anode load... .. | 100,000 |
| R18 | V3 AVC diode load ... | 500,000 |
| R19 | V4, V5 CG's resistance ... | 250,000 |
| R20 | V4, V5 fixed GB resistance... .. | 140 |
| R21 | V4 anode stopper ... | 100 |
| R22 | V5 anode stopper ... | 100 |
| R23 | Variable tone control ... | 50,000 |
| R24 | T.I. anode HT feed ... | 2,000,000 |
| R25 | T.I. CG resistance ... | 1,000,000 |

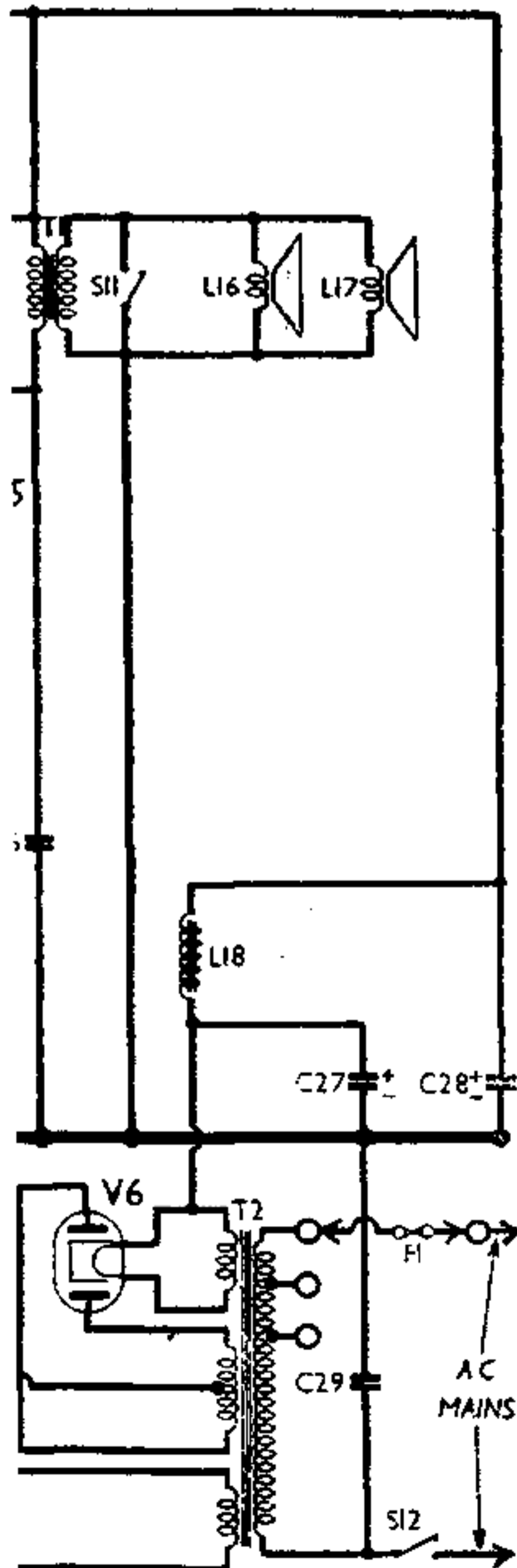

Circuit diagram of the Decca AW10. Note in the cathode return circuit of V4, V5, the relay winding, which operates in conjunction with S10.

| CONDENSERS | | Values (μ F) |
|------------|--------------------------------------|----------------------|
| C1 | Aerial IF filter tuning ... | 0.00006 |
| C2 | Aerial coupling condenser ... | 0.0003 |
| C3 | Part aerial LW coupling ... | 0.00125 |
| C4 | V1 hexode CG condenser ... | 0.0001 |
| C5 | V1 hexode CG decoupling ... | 0.02 |
| C6 | V1 cathode by-pass ... | 0.1 |
| C7 | V1 osc. CG condenser ... | 0.0001 |
| C8 | Osc. circuit SW tracker ... | 0.003 |
| C9 | Osc. circuit LW tracker ... | 0.000385 |
| C10 | Osc. circuit MW tracker ... | 0.0001808 |
| C11 | Osc. circuit LW fixed trimmer ... | 0.000045 |
| C12 | V1 osc. anode coupling condenser ... | 0.0002 |
| C13 | V2 CG decoupling ... | 0.02 |
| C14 | V1, V2 SG's decoupling ... | 0.1 |
| C15 | V2 Cathode by-pass ... | 0.1 |
| C16 | T.I. CG decoupling ... | 0.01 |
| C17 | IF by-pass ... | 0.0001 |
| C18 | AF coupling to V3 triode ... | 0.02 |
| C19 | IF by-pass ... | 0.0001 |
| C20* | V3 triode anode decoupling ... | 4.0 |
| C21 | Coupling to V3 AVC diode ... | 0.0001 |
| C22* | V3 cathode by-pass ... | 50.0 |
| C23 | V3 triode to V4, V5 AF coupling ... | 0.01 |
| C24* | V4, V5 cathodes by-pass ... | 50.0 |
| C25 | Part of variable tone control ... | 0.05 |
| C26 | Fixed tone corrector ... | 0.006 |
| C27* | HT smoothing condensers | 10.0 |
| C28* | | 10.0 |
| C29 | Mains RF by-pass ... | 0.006 |
| C30† | Aerial circuit SW trimmer ... | — |
| C31† | Aerial circuit LW trimmer ... | — |
| C32† | Aerial circuit MW trimmer ... | — |
| C33† | Aerial circuit tuning ... | — |
| C34† | Oscillator circuit tuning ... | — |
| C35† | Osc. circuit SW trimmer ... | — |
| C36† | Osc. circuit LW trimmer ... | — |
| C37† | Osc. circuit MW trimmer ... | — |
| C38† | 1st IF trans. pri. tuning ... | — |
| C39† | 1st IF trans. sec. tuning ... | — |
| C40† | 2nd IF trans. pri. tuning ... | — |
| C41† | 2nd IF trans. sec. tuning ... | — |

* Electrolytic. † Variable. ‡ Pre-set.
§ 0.000012 and 0.000168-8 in parallel.

| OTHER COMPONENTS | | Approx. values (ohms) |
|------------------|----------------------------------------|--------------------------|
| L1 | Aerial IF filter coil ... | 8.5 |
| L2 | Aerial SW coupling coil ... | 3.0 |
| L3 | Aerial MW and LW coupling coil ... | 14.0 |
| L4 | Aerial SW tuning coil ... | Very low |
| L5 | Aerial LW tuning coil ... | 19.0 |
| L6 | Aerial MW tuning coil ... | 3.5 |
| L7 | Osc. circuit SW tuning coil ... | Very low |
| L8 | Osc. circuit LW tuning coil ... | 5.5 |
| L9 | Osc. circuit MW tuning coil ... | 2.5 |
| L10 | Oscillator SW reaction ... | 1.0 |
| L11 | Oscillator MW and LW reaction coil ... | 2.8 |
| L12 | 1st IF trans. { Pri. ... | 7.0 |
| L13 | | { Sec. ... |
| L14 | 2nd IF trans. { Pri. ... | 7.0 |
| L15 | | { Sec., total ... |
| L16 | Speaker speech coils ... | 3.0 |
| L17 | HT smoothing choke ... | 300.0 |
| L18 | Speaker input trans. { Pri. ... | 0.2 |
| T1 | { Sec. ... | 34.0 |
| T2 | Mains trans. { Pri., total ... | 0.2 |
| | { Heater sec. ... | 0.2 |
| | { Rect. heat. sec. ... | 0.2 |
| | { HT sec., total ... | 370.0 |
| F1 | Mains circuit fuse ... | — |
| S1-S9 | Waveband switches ... | — |
| S10 | Relay shorting switch ... | — |
| S11 | Speaker muting switch ... | — |
| S12 | Mains switch, ganged R14 ... | — |

VALVE ANALYSIS

Valve voltages and currents given in the table (col. 2) are those measured in our receiver when it was operating on mains of 235V, using the 200-230V tapping on the mains transformer. The receiver was tuned to the lowest wavelength on the MW band and the volume control was at maximum, but there was no signal input.

Voltages were measured on the 400V

scale of a model 7 Universal Avometer, chassis being negative.

If, as in our case, V2 should become unstable when its currents are being measured, it can be stabilised by connecting a non-inductive condenser (about 0.1 μ F) between its top-cap and chassis.

| Valve | Anode Voltage (V) | Anode Current (mA) | Screen Voltage (V) | Screen Current (mA) |
|---------|-------------------|--------------------|--------------------|---------------------|
| V1 TH62 | 268 | 2.9 | 100 | 2.6 |
| | Oscillator | | | |
| V2 6U7G | 115 | 4.3 | 100 | 2.5 |
| | 268 | | | |
| V3 6Q7G | 145 | 0.45 | — | — |
| V4 6V6G | 240 | 41.0 | 268 | 4.5 |
| V5 6V6G | 240 | 41.0 | 268 | 4.5 |
| V6 5Z4G | 315† | — | — | — |
| T.I.EM4 | 7 | 0.1 | — | — |
| | Target | | | |
| | 268 | 0.5 | — | — |

† Each anode, AC

GENERAL NOTES

Switches.—S1-S9 are the waveband switches, in a single rotary unit beneath the chassis. Its position is indicated in our underchassis view, and a diagram in column 3 shows the unit in detail as seen when viewed from the rear of the underside of the chassis. The table (below) gives the switch positions for the three control settings, starting from fully anti-clockwise. A dash indicates open, and C, closed.

| Switch | SW | MW | LW |
|--------|----|----|----|
| S1 | C | — | — |
| S2 | — | — | C |
| S3 | C | — | — |
| S4 | — | C | — |
| S5 | C | — | — |
| S6 | — | — | C |
| S7 | — | C | — |
| S8 | C | — | — |
| S9 | — | C | C |

S10, S11.—These two switches are comprised in a leaf-type unit, which is mounted on the mechanical press-button unit on the chassis deck and operated by a rocker plate associated with the press-buttons. Normally, S10 is closed, and S11 open, but when a button is pressed, S11 closes to mute the receiver during the operation, while S10, which short-circuits the relay winding, opens to permit the relay to operate.

A diagram of the unit appears beneath the S1-S9 diagram in column 3.

S12.—This is the QMB mains switch, ganged with the volume control R14.

Coils.—The aerial circuit intermediate frequency filter coil L1 is mounted on the rear member of the chassis near the aerial socket. Its adjustment screw, which protrudes through the chassis, is indicated in our plan view.

The RF and oscillator coils L2, L4; L3, L6; L5; L7, L10; and L8, L9, L11 are in five unscreened tubular units beneath the chassis, all the associated trimmers and trackers being mounted on the appropriate units. They can be seen in a group to the right in our underchassis view.

In connection with the circuit diagram, it should be noted that the coil positions do not follow our usual practice: owing to the aerial circuit switching, it has been considered ad-

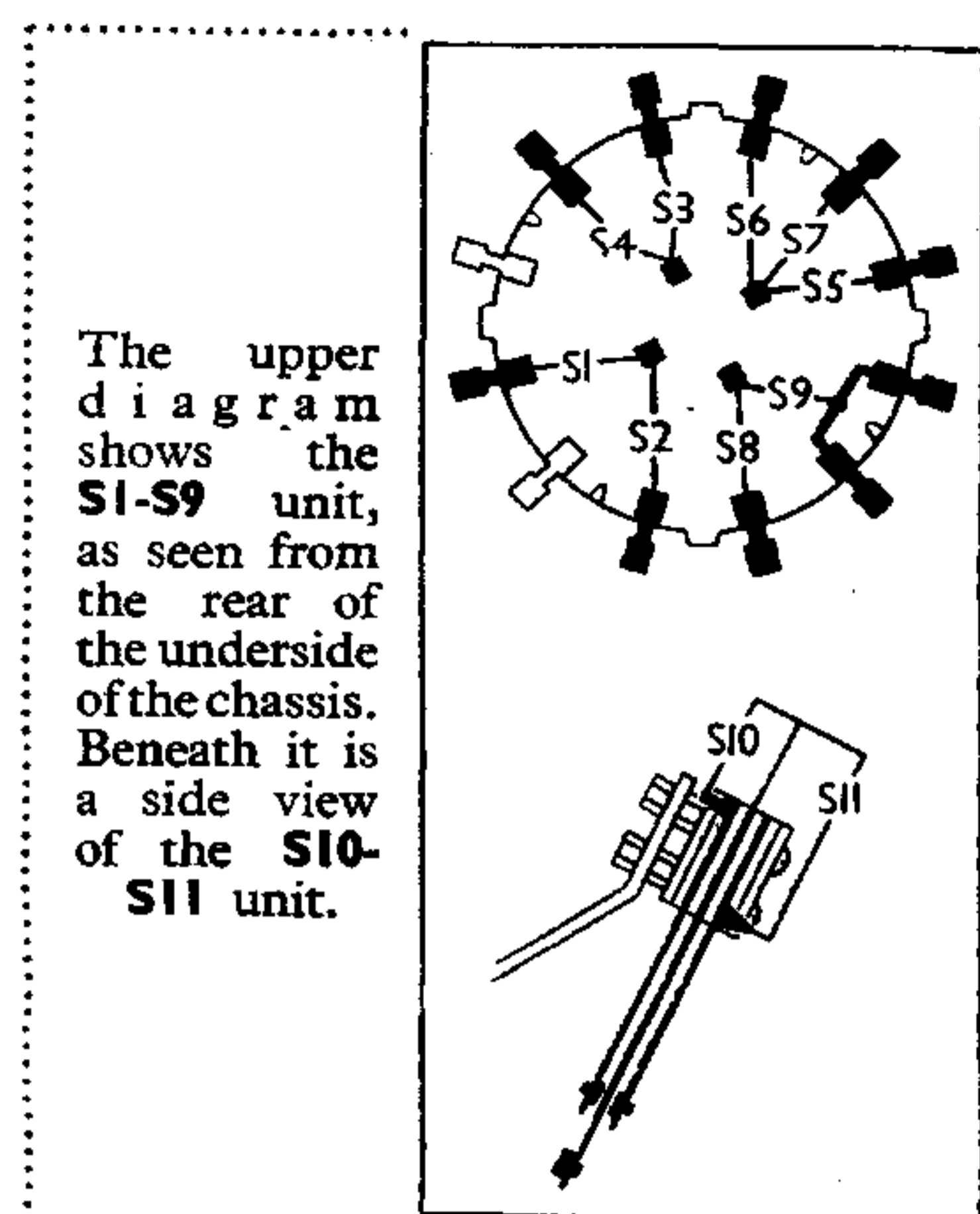

The upper diagram shows the S1-S9 unit, as seen from the rear of the underside of the chassis. Beneath it is a side view of the S10-S11 unit.

visable, for the sake of clarity, to transpose the MW and LW coils, so that the LW coil L5 is above the MW coil L6, instead of below it; the oscillator coils have been similarly transposed in conformity with the aerial coils.

The intermediate frequency transformers L12, L13 and L14, L15 are in two screened units on the chassis deck with their associated silver tempa trimmers.

L18.—This is the HT smoothing choke. It is not shown in our chassis illustrations, as it is mounted on the left-hand speaker unit, when viewed from the rear of the cabinet. Its counterpart on the right-hand unit is the speaker input transformer T1.

Scale Lamps.—These are two MES types, with round bulbs, rated at 6 V, 0.5A.

External Speaker.—Two sockets are provided at the rear of the chassis for a high impedance (7,000-10,000 Ω) speaker. The sockets are not isolated from the HT supply.

Relay Clutch.—In order to eliminate the drag imposed upon the press-button movement by the slow motion tuning drive, a relay clutch system, which converts the drive into a direct one when a press-button is operated, has been devised.

Until the relay is energised, its armature lies on the milled edge of the slow motion friction drive casing, and is held down in that position by a coil spring so that it acts as a brake and prevents the drive casing from moving.

When one of the press-buttons is operated, however, S10, which otherwise short-circuits the relay winding, opens, and the relay becomes energised and attracts the armature, which thus releases its grip on the drive casing. Since this casing can now turn, the friction drive becomes inoperative, so that the drive ratio between the gang spindle and the control spindle becomes one-to-one, and quite a light pressure on a press-button is sufficient to operate the mechanism.

Condensers C27, C28.—These are two 10 μ F (450 V working) electrolytics in a single tubular metal case, which forms the common negative connection and is

soldered to the chassis. The tag with a square aperture cut in the insulating material at its base is the positive of C27 and is connected to V6 valveholder, while that with the diamond shaped aperture is the positive of C28.

C9.—This is made up of a 0.000012 μ F and 0.0001688 μ F connected in parallel. The total capacity is 0.0001808 μ F.

Fuse F1.—This consists of a short piece of wire mounted in an ebonite tube between two brass pins which are screwed through one side of the tube. The complete unit is used as a plug-in voltage adjustment strap. Fuse replacements should be made with 2A fuse wire.

PRESS-BUTTON UNIT

A mechanical press-button unit is employed for automatic tuning. The diagram below shows a sectional view of one of the press-button movements.

The gang condenser spindle is connected up by means of a bell-crank and a system of connecting links to a framework consisting of two rigid parallel rods, A, A, held in end plates B, and the whole frame is arranged to pivot on two bearings.

Rotation of the frame is transmitted to the gang spindle via the crank and connecting links.

Each press-button (of which there are six) actuates a plunger carrying a metal contact plate C, and when the plunger is depressed this plate moves forward until it encounters one or other of the rods in the frame. Further movement of the plunger causes the plate C to push the rod and so rotates the frame (and the gang) until the plate also comes into contact with the other rod.

When this is the case, pressure on the plunger will cause no further rotation of the frame, and the gang is accurately positioned. When the plunger pressure is released, a return spring F carries it back to its normal position, but the frame does not move until another plunger, adjusted for a different station, is pressed.

The final position of the frame, and hence the selection of stations, is achieved by making the metal contact plate rotatable, which adjusts the angle of its contact edge relative to the axis of the plunger.

The plate is pivoted at D, and can be clamped in any position by a screw device E, which is locked by screwing up the actual press button.

To adjust for a particular station, the button which is to receive it is unscrewed a turn or so, and the station is tuned in by the manual drive. The button is then fully depressed, and since the metal contact plate C is now free, it

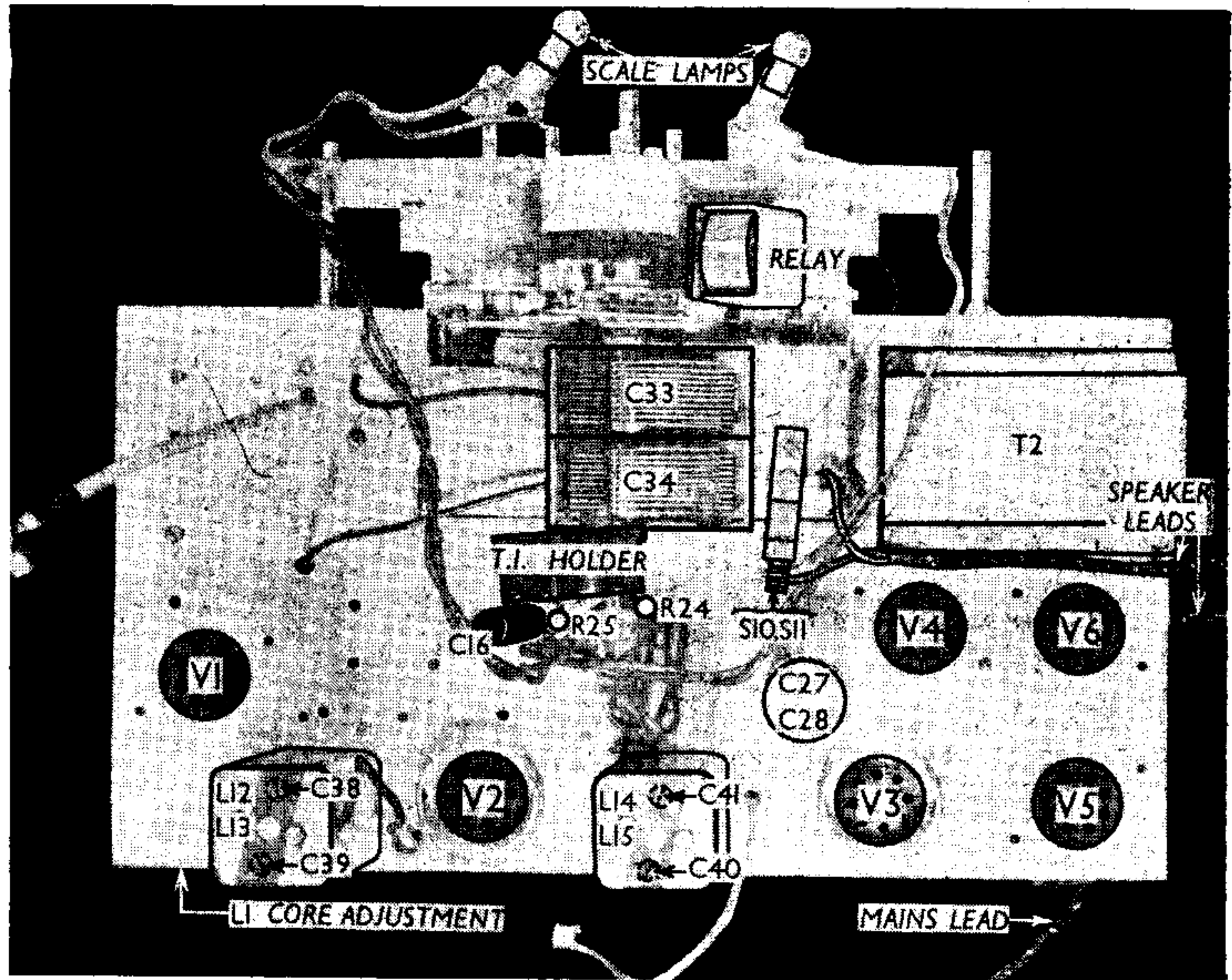

Plan view of the chassis. S10, S11 are leaf switches for muting the speaker and operating the relay when a button is pressed. The relay is also shown.

takes up its correct position relative to the parallel rods A, A of the frame, without rotating the frame. The button is now screwed up, and the contact plate is firmly locked in position, so that future operation of the particular button will always rotate the frame to the correct angle for the reception of the chosen station.

CIRCUIT ALIGNMENT

IF Stages.—Switch set to LW, short-circuit C34, connect signal generator between control grid (top cap) of V1 and chassis, leaving existing connection in place. Feed in a 465KC/S signal, and adjust C38, C39, C40 and C41 for maximum output.

Transfer signal generator leads to A and E sockets via a suitable dummy aerial, feed in a strong 465KC/S signal, and adjust the core of L1 for minimum output.

RF and Oscillator Stages.—With the gang at either extremity of its travel, the pointer should lie level with the top of the flange supporting the black scale background plate. Signal generator should be connected to A and E sockets via a suitable dummy aerial. It should be observed that, as the scale is fixed to the front of the cabinet, and not to the chassis, if the process

is carried out with the chassis removed from the cabinet, the scale cannot be utilised during alignment. Adjustment is difficult when the chassis is in the cabinet. The procedure is as follows, and should be executed in that order:

MW.—Switch set to MW, adjust tuning control so that the end of the pointer is three-eighths of an inch from its position at minimum gang capacity, i.e.: from the top of the flange supporting the scale backing. Feed in a 200 m (1,500 KC/S) signal, and adjust C37, then C32, for maximum output. Check at 220 m, 350 m and 500 m (1,360, 858 and 600 KC/S).

LW.—With receiver still switched to MW, feed in a 296.2 m (1,013 KC/S) signal and tune it in accurately. Switch set to LW, feed in a 1,293 m (232 KC/S) signal and, without moving the gang, adjust C36, then C31, for maximum output. Check at 1,500 m (200 KC/S) and see that it coincides with the pointer setting for 342.1 m (877 KC/S) on the MW band.

When the receiver was designed, this method of alignment was intended to ensure that the positions of Midland Regional and Luxembourg; and London Regional and Droitwich, coincided on the tuning scales, for the convenience of the press-button system.

SW.—Switch set to SW, turn pointer to three-eighths of an inch from minimum gang position (as for 200 m position on MW band above), feed in a 16.6 m (18 MC/S) signal, and adjust C35, then C30, for maximum output. Check at 50 m (6 MC/S), when the end of the pointer should be three-quarters of an inch (vertically) above the scale-backing flange, the top of which is level with the pointer when the gang is at maximum.

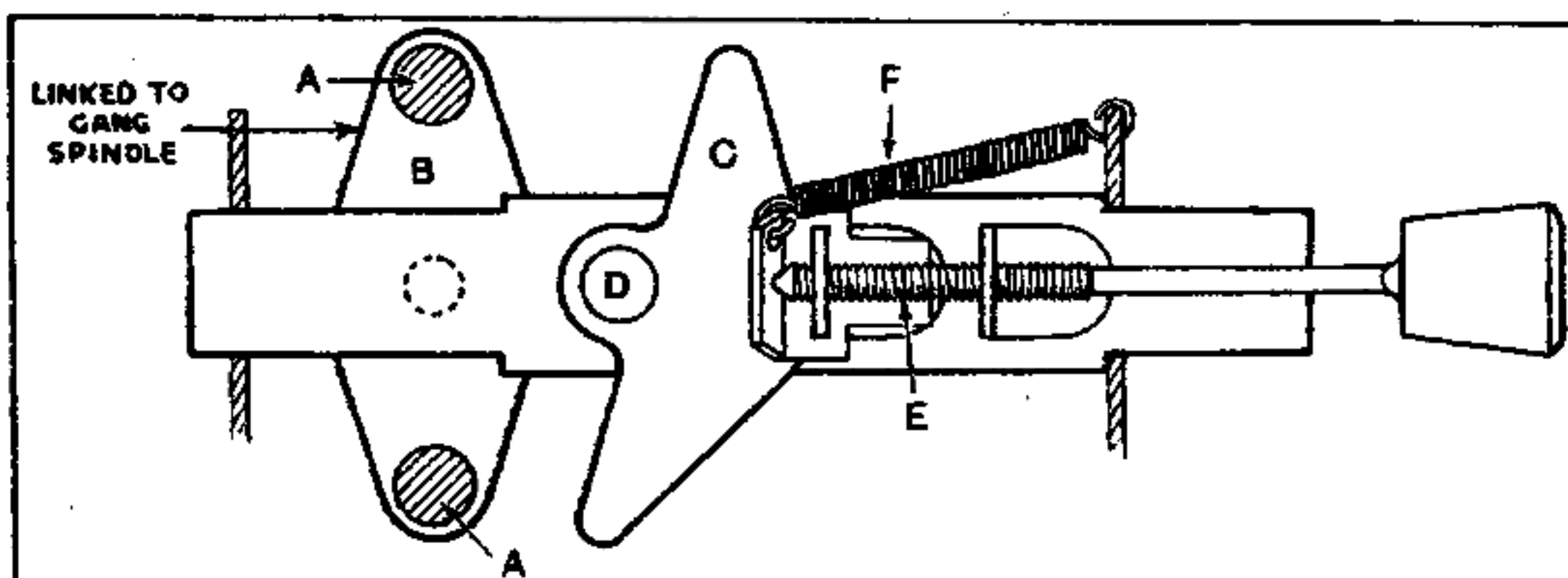

Diagram showing the essential parts of the mechanical press-button system employed.