

MODEL 36 DC

Ned. Ver. v. Historie v/d Radio COLONIAL RADIO CORP.

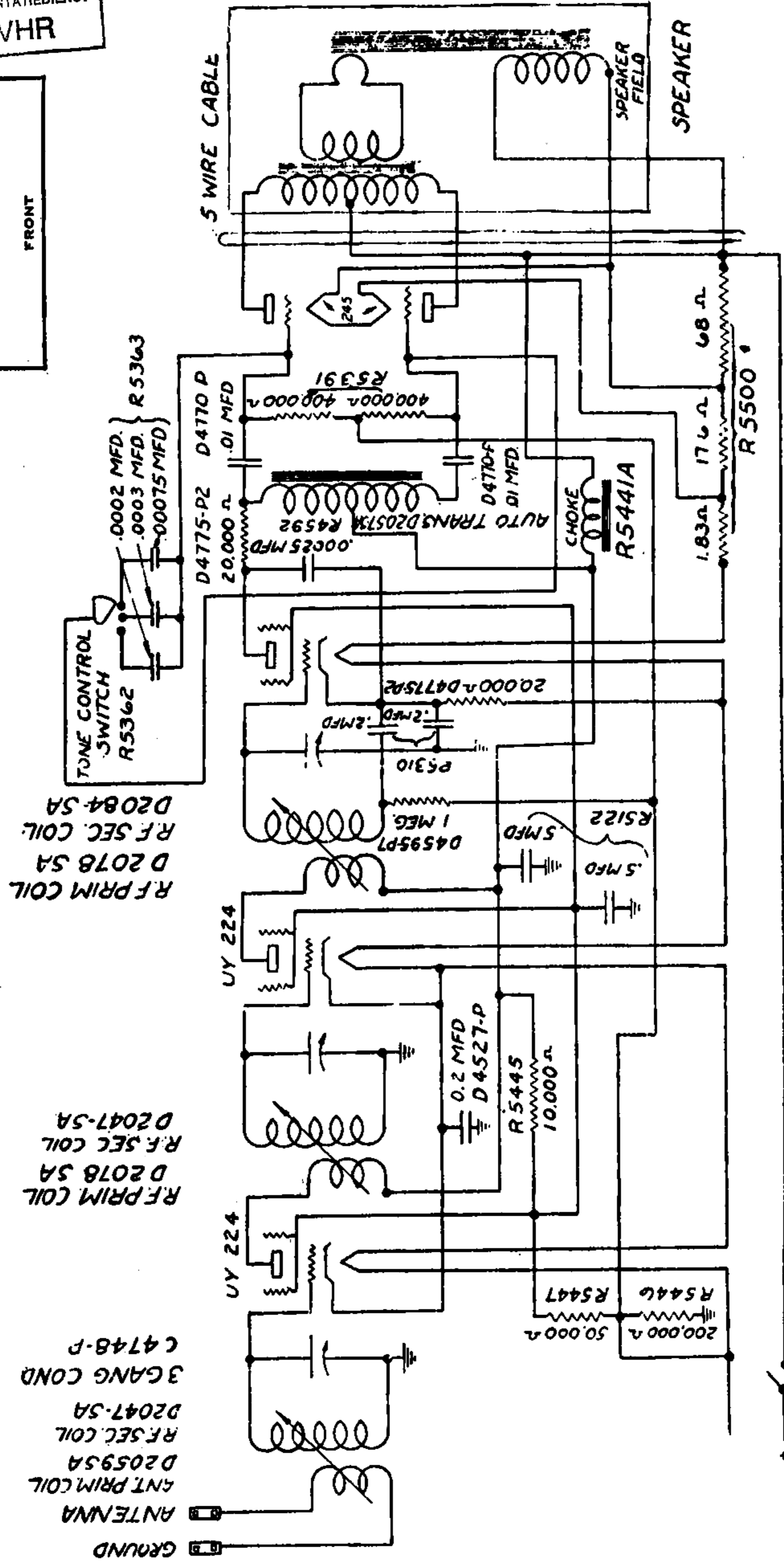
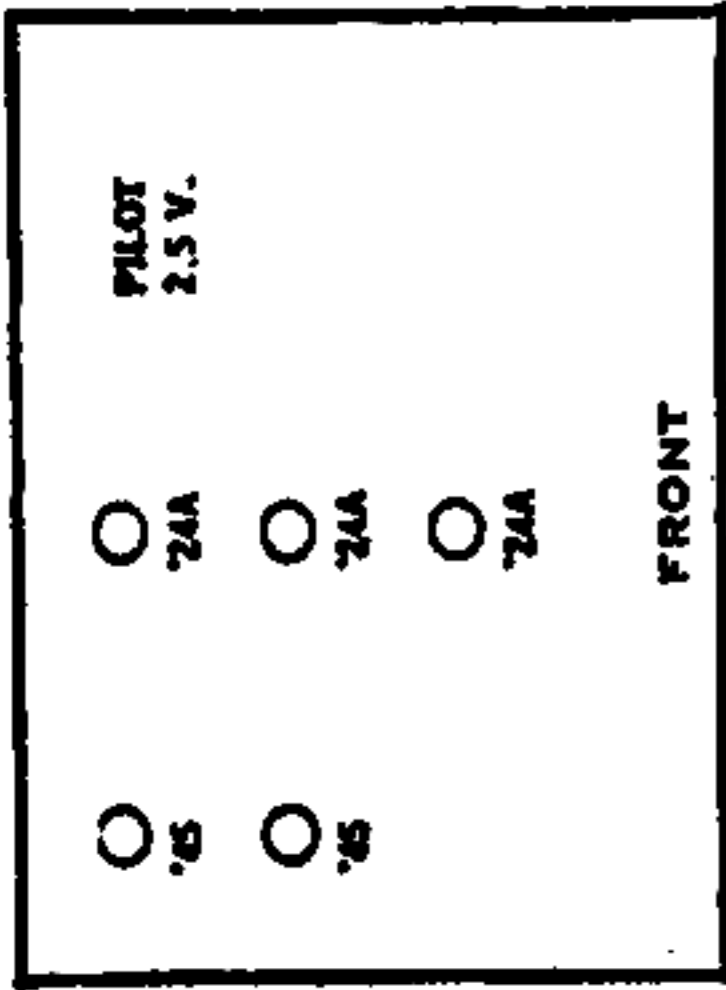

ANTENNA  
ANT. PRIM. COIL  
D2059SA  
R.F. SEC. COIL  
D2047-SA  
3 GANG COND  
C4748-P  
UY 224  
R.F. PRIM. COIL  
D2078 SA  
R.F. SEC. COIL  
D2047-SA  
UY 224  
R.F. PRIM. COIL  
D2078 SA  
R.F. SEC. COIL  
D2078 SA  
R.F. SEC. COIL  
D2084-SA  
TONE CONTROL SWITCH  
R5362  
.0002 MFD.  
.0003 MFD.  
.00075 MFD.  
R5363

CANOPY SWITCH  
R5356

MODEL 36  
114  
Parts illus.

COLONIAL RADIO CORP.

MODEL 36, 114.

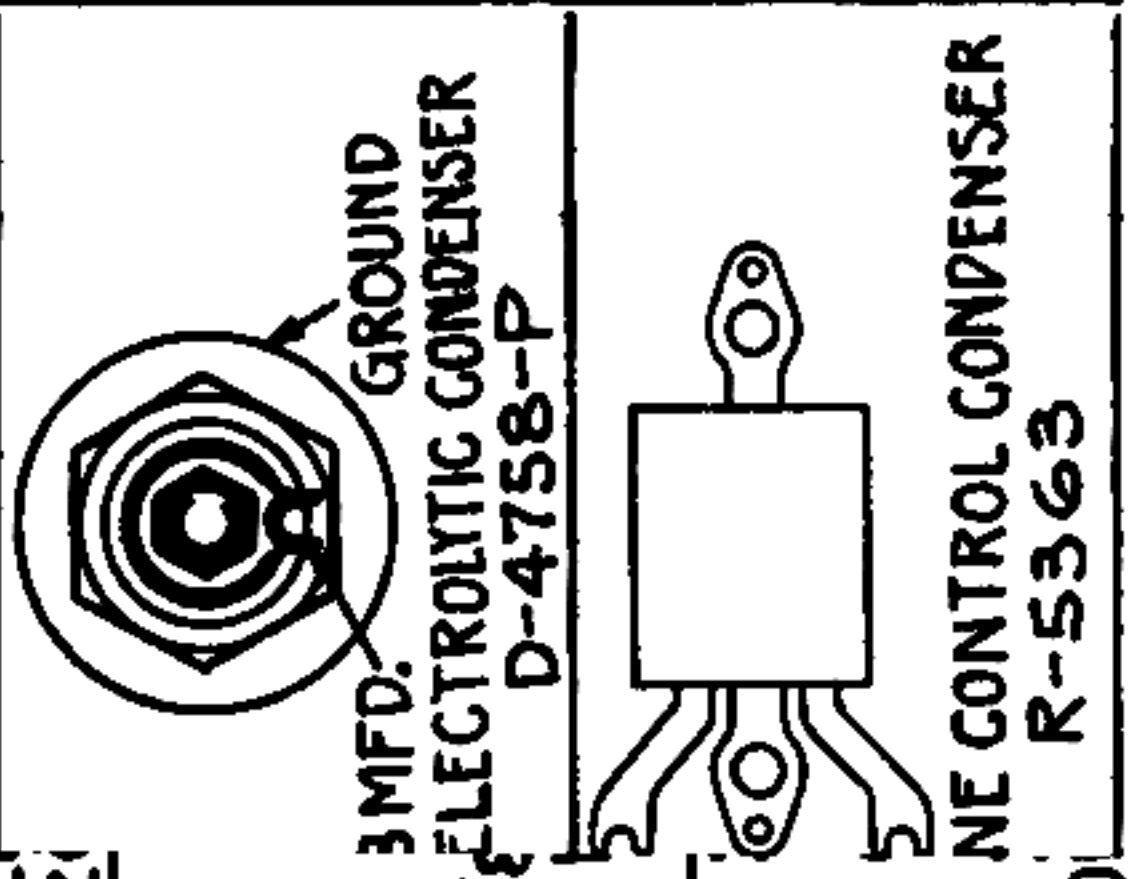
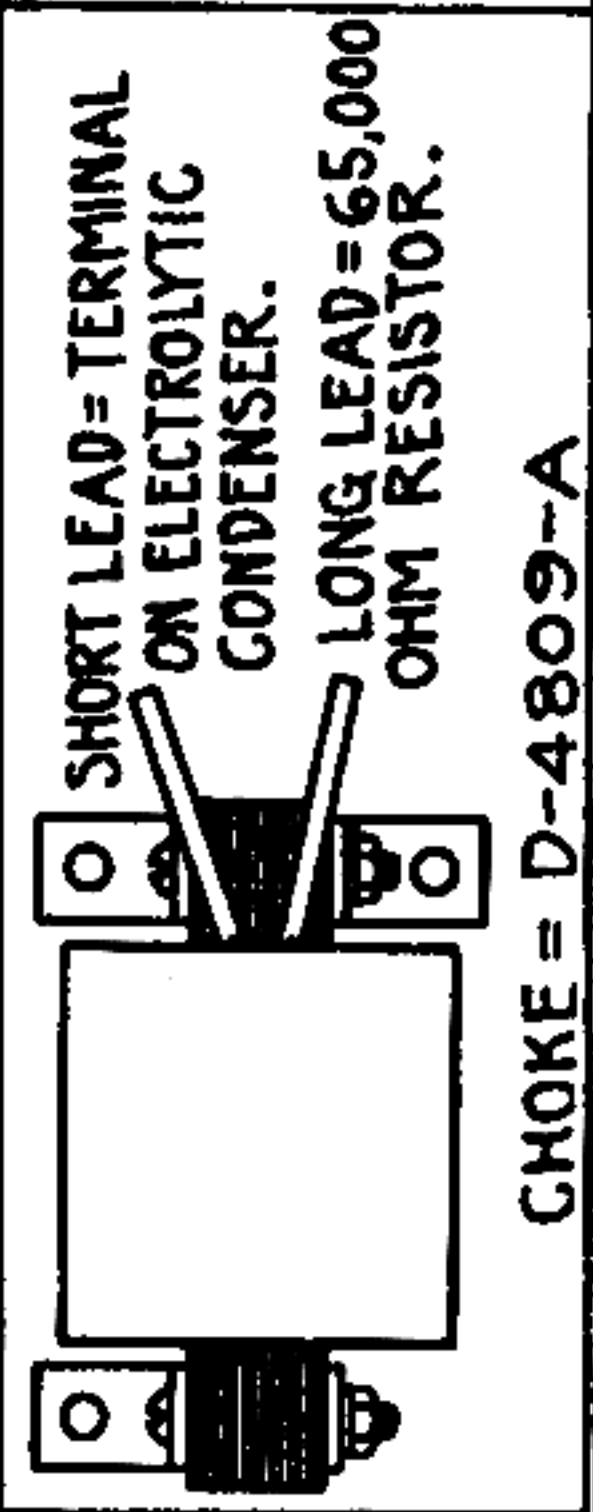
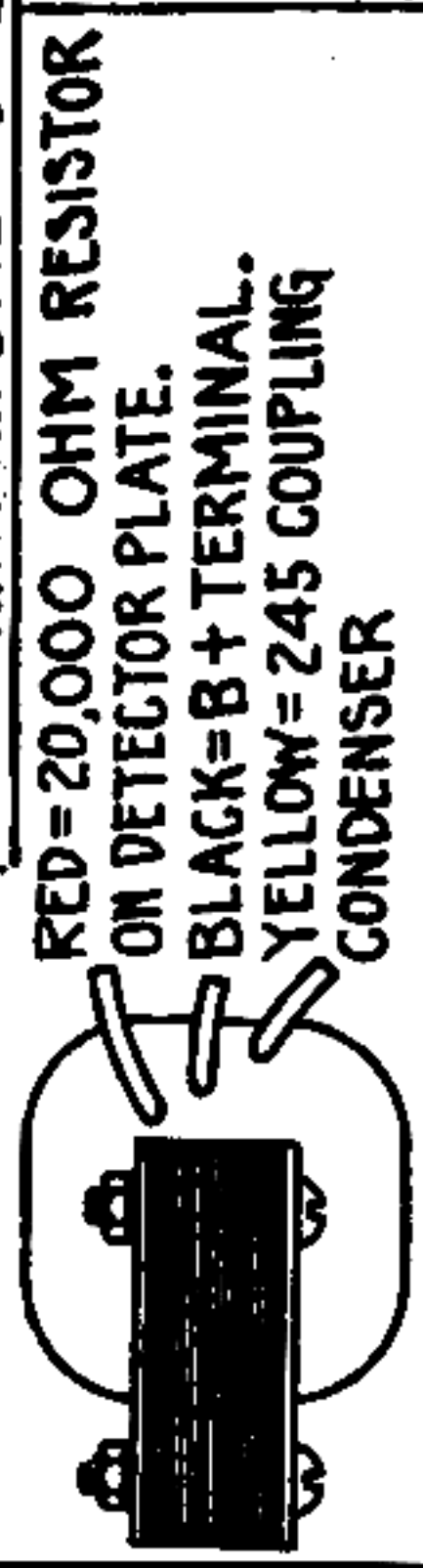
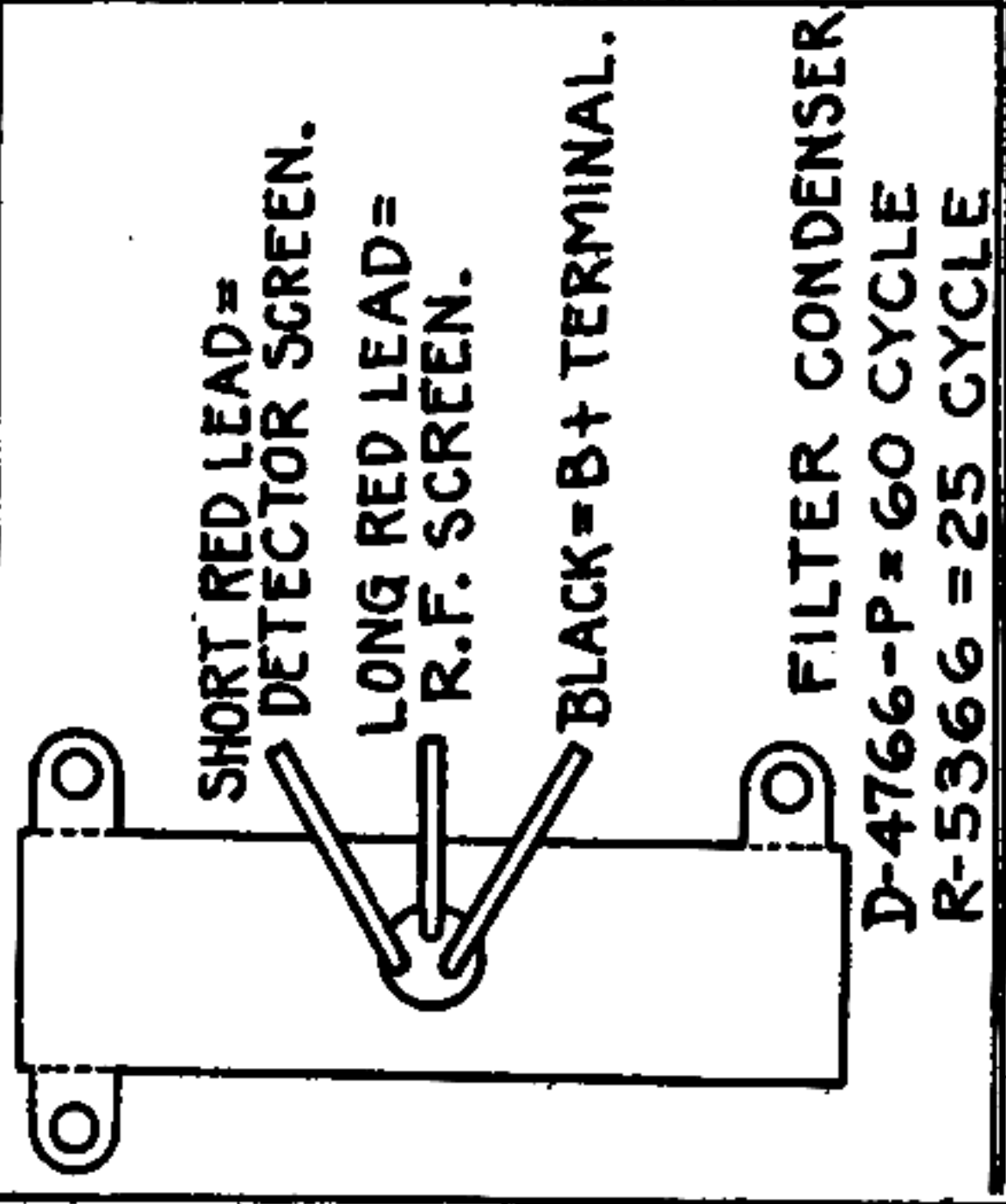
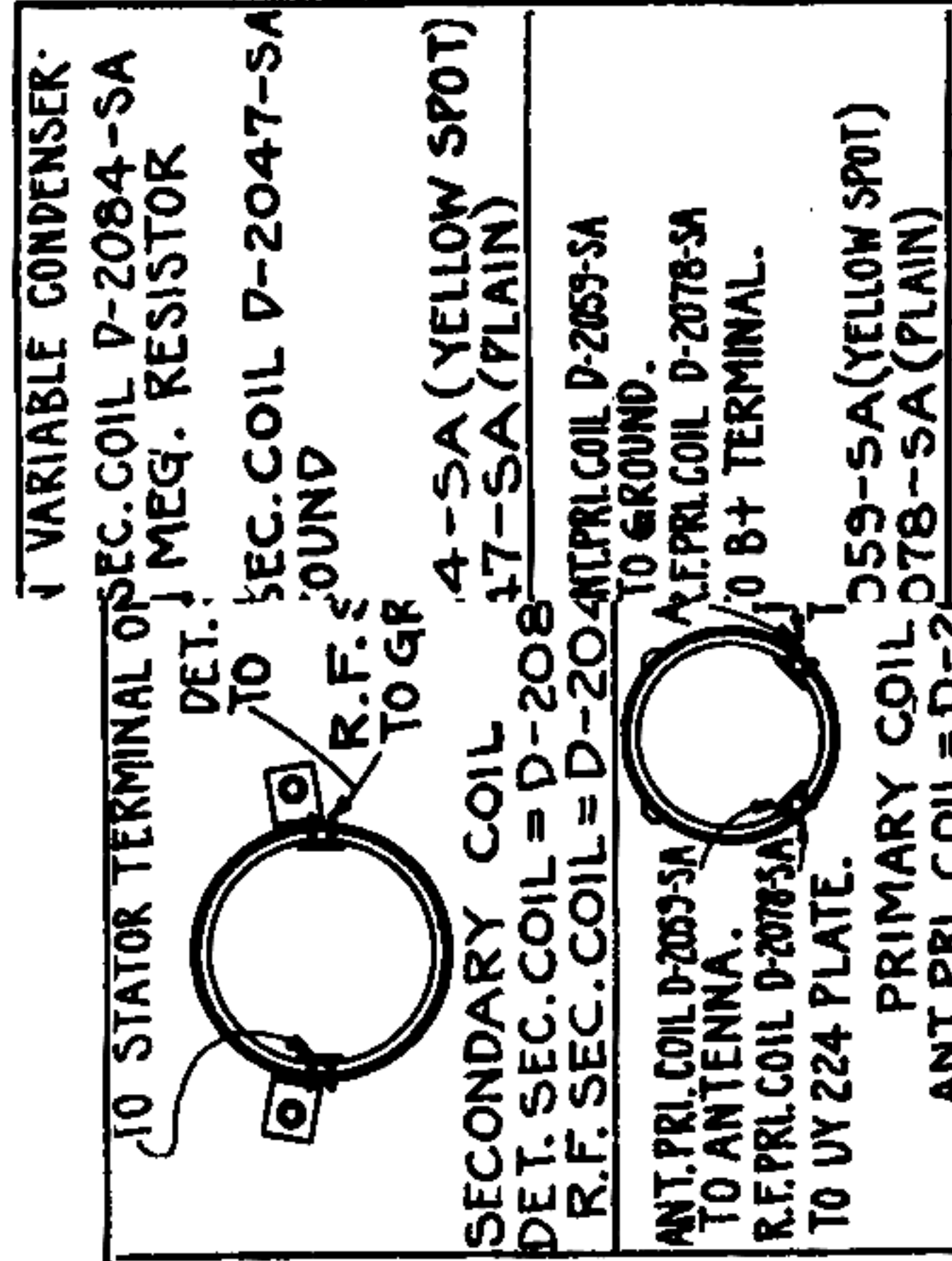
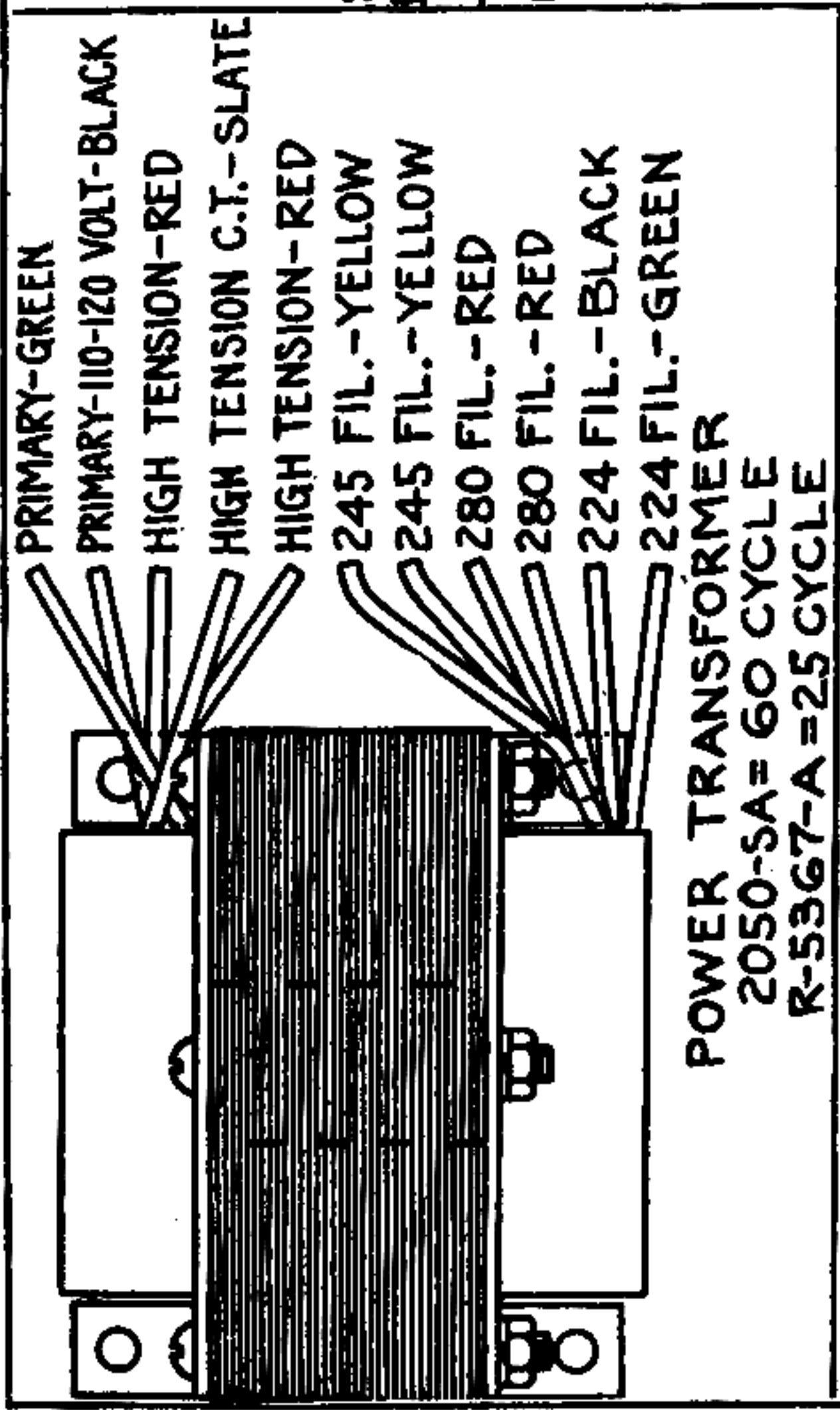

LEAD DETAILS OF POWER & AUTO TRANSFORMER; CHOKES; FILTER, TONE CONTROL, & ELECTROLYTIC CONDENSERS-PRIMARY & SECONDARY R.F. COILS.

MODEL 36

114

Chassis and Parts

COLONIAL RADIO CORP.

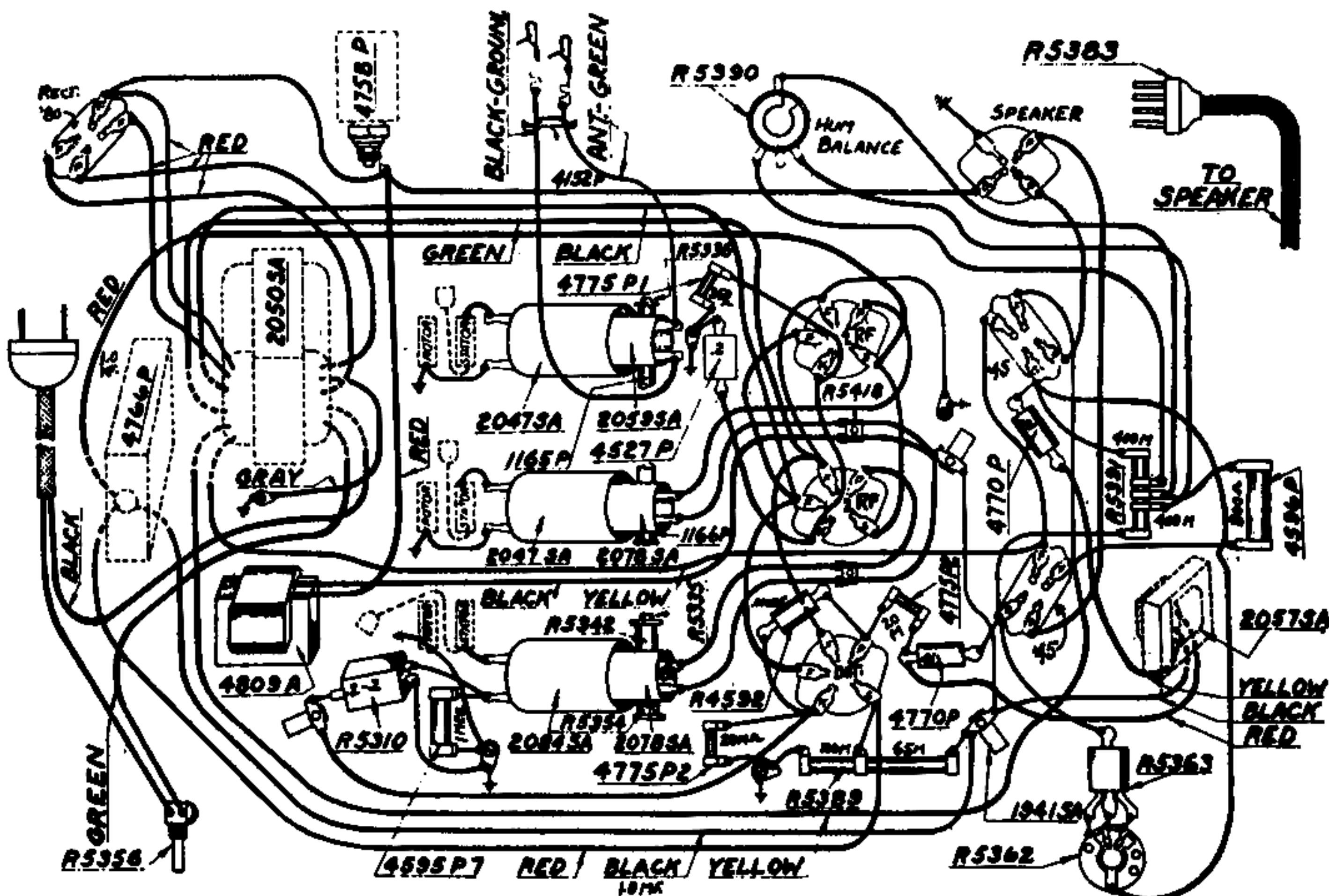

CHASSIS WIRING

MODEL 36, 114.

**MODELS 36, 36-P & 41-P  
Parts list & color code.**

- |            |   |
|------------|---|
| R-1354     | Resistor 50 M. ohm Grey (D.C.)          |
| D-4527-P   | Condenser .2 Midget                     |
| R-4592     | Condenser .0025 Mfd.                    |
| D-4595-P-7 | Resistor .1 Meg. Blue                   |
| D-4696-P   | Resistor 800 ohm - Purple               |
| D-4766-P   | Condenser 1.5 Filter                    |
| D-4770-P   | Condenser .01 Midget                    |
| D-4775-P-1 | Resistor - 350 ohm Black                |
| D-4775-P-2 | " - 20 M ohm Grey                       |
| D-4782-P   | Resistor 800 M ohm Yellow Tapped (D.C.) |
| R-5122     | Condenser .5 Dual (D.C.)                |
| R-5310     | Condenser .2 Dual                       |
| R-5366     | Resistor 800 M ohm Yellow               |
| R-5369     | Condenser - .5 Mfd. 25 cycle Filter     |
| R-5389     | Spacer - Dual .5 cond. (D.C.)           |
| R-5390     | Resistor - 165 M. ohm Green & Black     |
| R-5431     | Potentiometer 600 ohm                   |
| R-5445     | Speaker 10"                             |
| R-5447     | Resistor 10 M ohm Black (D.C.)          |
| R-5544     | Resistor 50 M ohm Red (D.C.)            |
| R-5819     | Resistor - large (D.C.)                 |
| R-5820     | Resistor 100 M. ohm R.M.A.              |
| R-5821     | Resistor 65 M. ohm R.M.A.               |
| R-5822     | Resistor 20 M. ohm R.M.A.               |
| R-5823     | Resistor 400 M. ohm R.M.A.              |
| R-5824     | Resistor 1 Meg. R.M.A.                  |
| R-5417     | Resistor 350 ohm R.M.A.                 |
|            | Filter Condenser                        |

Models 36, 38, 41, 42 (1930)

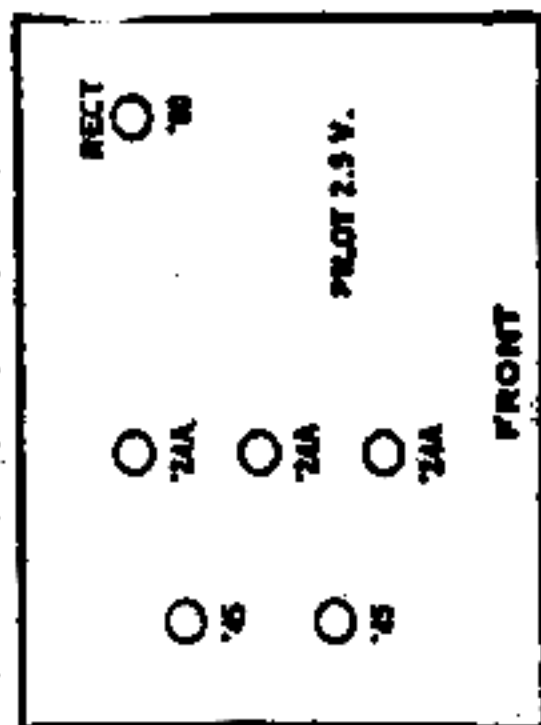

COLONIAL RADIO CORP.

MODEL 36  
 MODEL 36-P  
 MODEL 114

