

(linke Seite des Schaltbildes)

Braun FS I und FS G (Oszillogramme siehe S. 353)

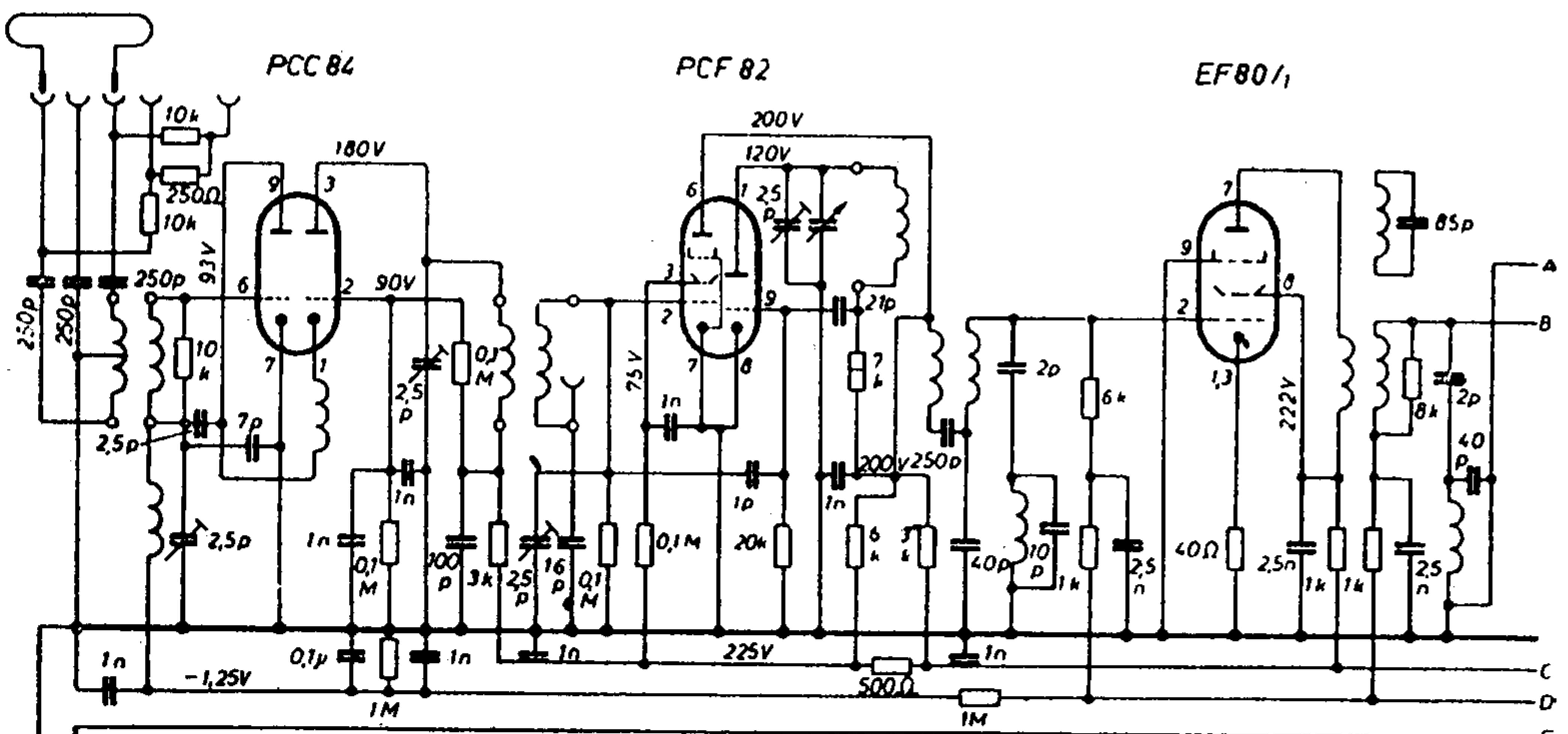

ZF = Bild: 25,75 MHz
Ton: 20,25 + 5,5 MHz

Ned. Ver. v. Historie v/d Radio

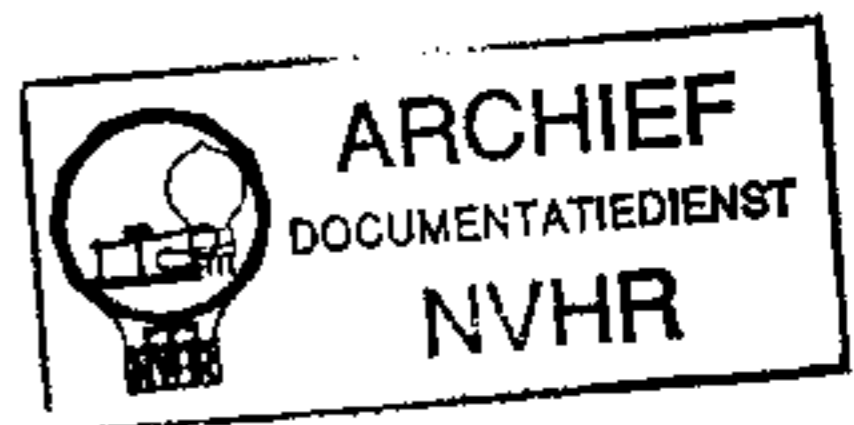

EF80/4

EAA91

PCL81/1

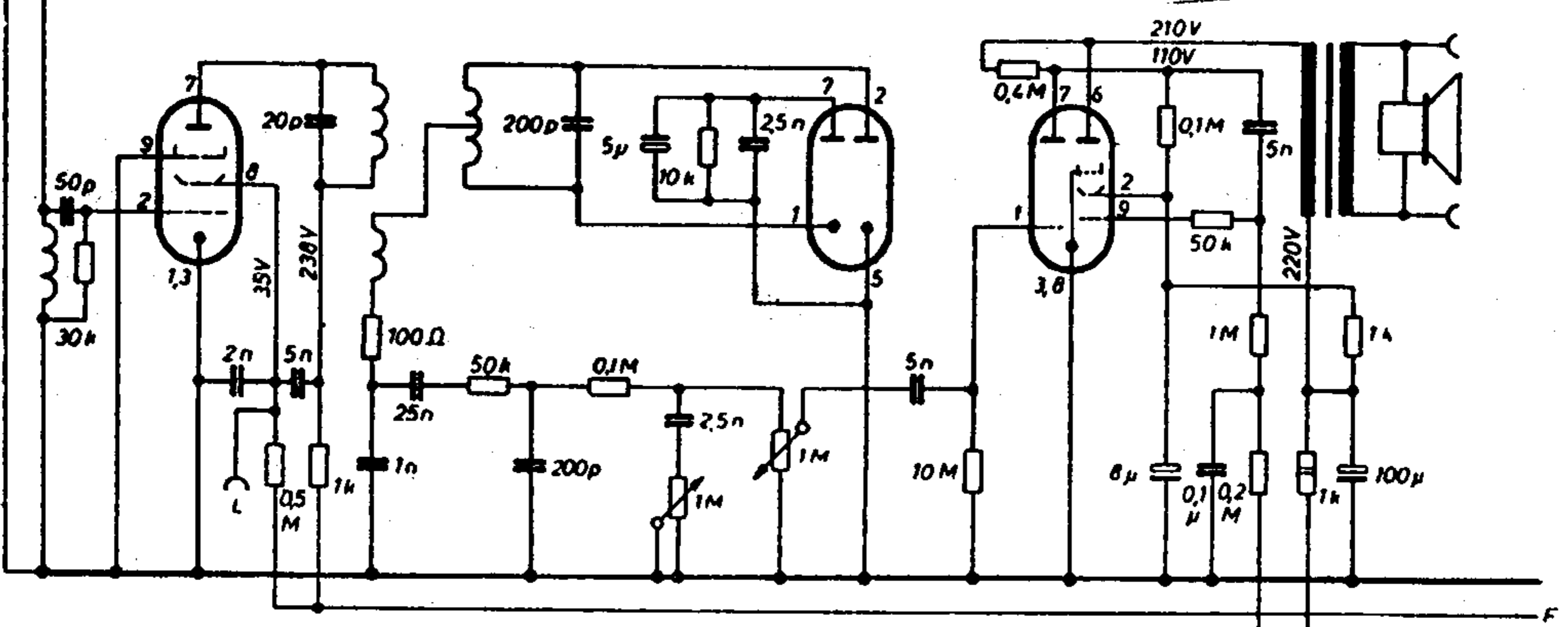

Spannungsmesser: 33kΩ / V (ohne Antenne, voller Kontrast)

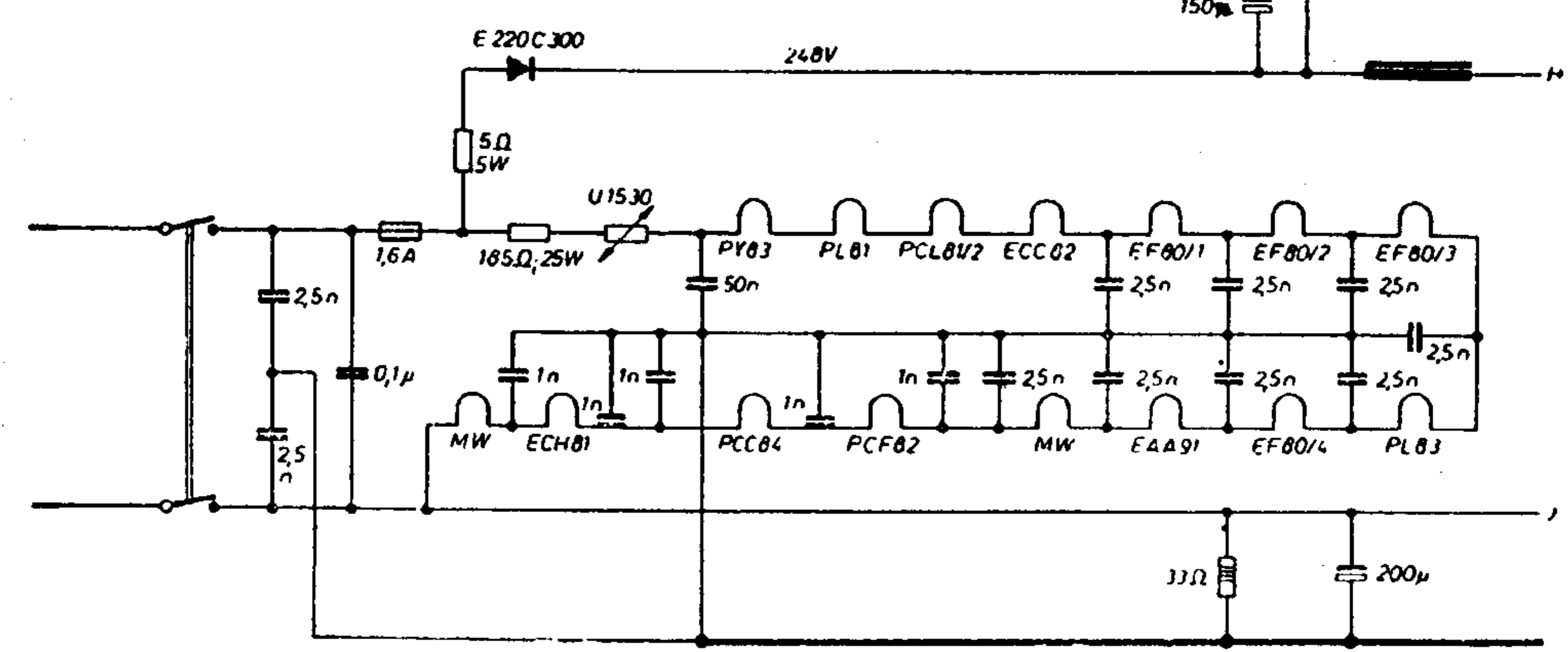

Oszillogramme zu Braun FS I und FSG (s. 954)



1



2

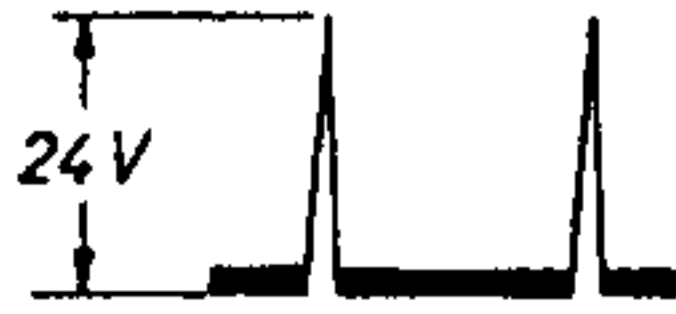

3



4



5

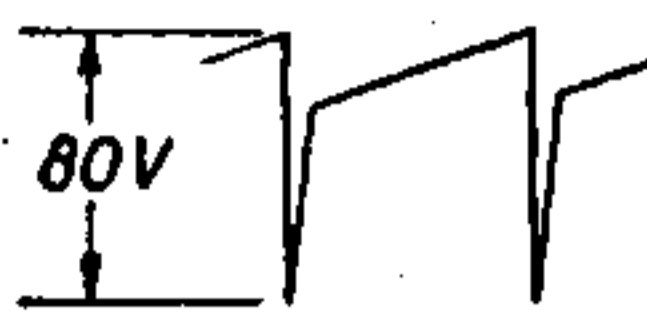

6

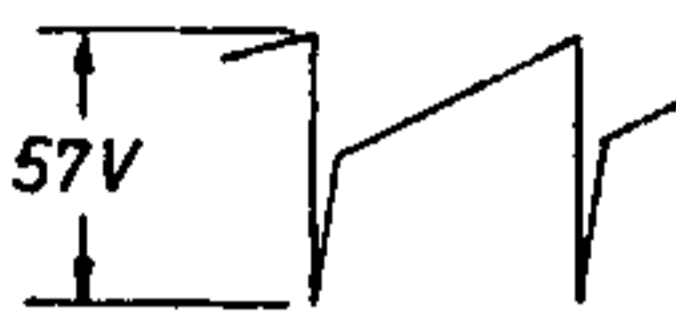

7



8

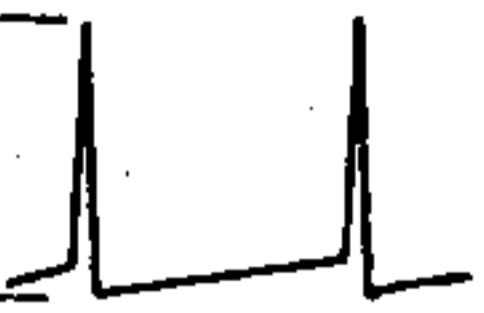

9

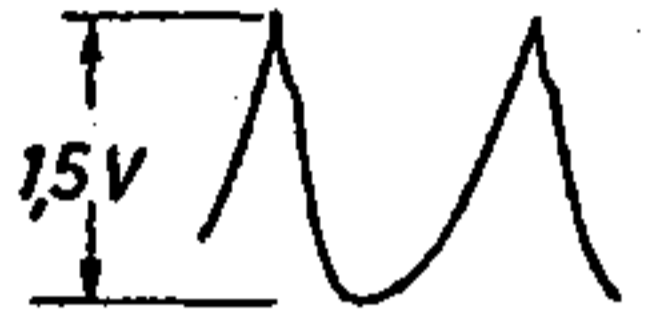

10



11



12



13



14



15

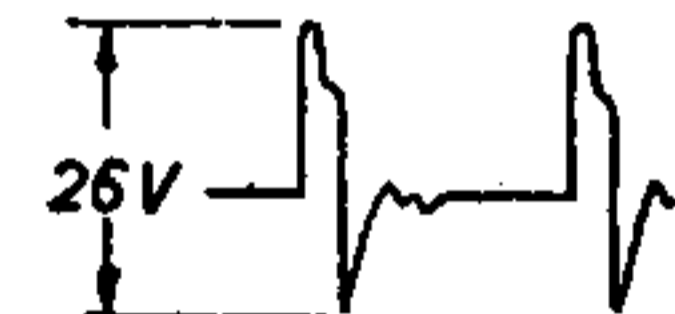

16



17



18

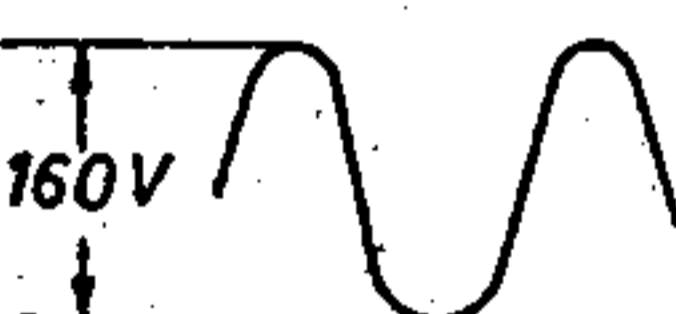

19

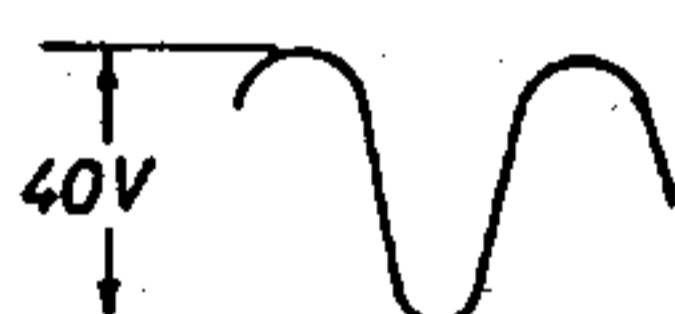

20

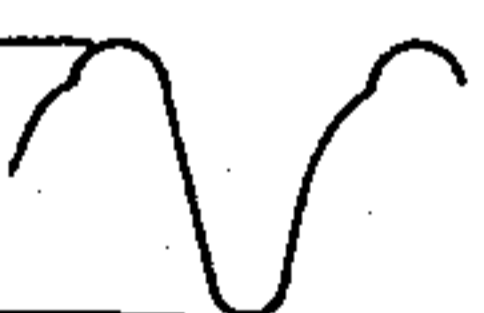

21



22

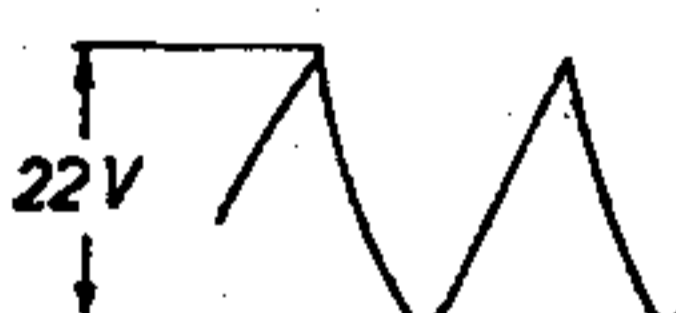

23

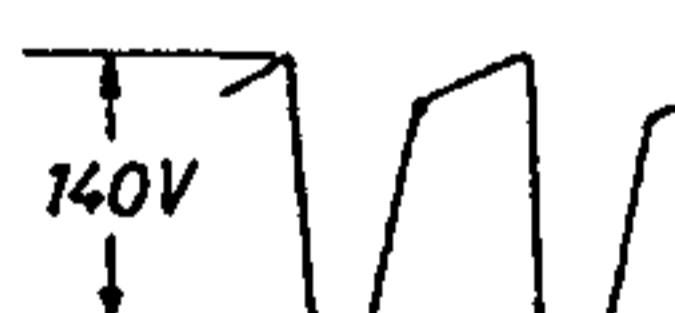

24



25



26



27



28



29



30