

Spannungen und Ströme mit Multipl. X
in Schalterstellung MW gemessen
Eingeklammerte Werte in Schalterstellung UKW

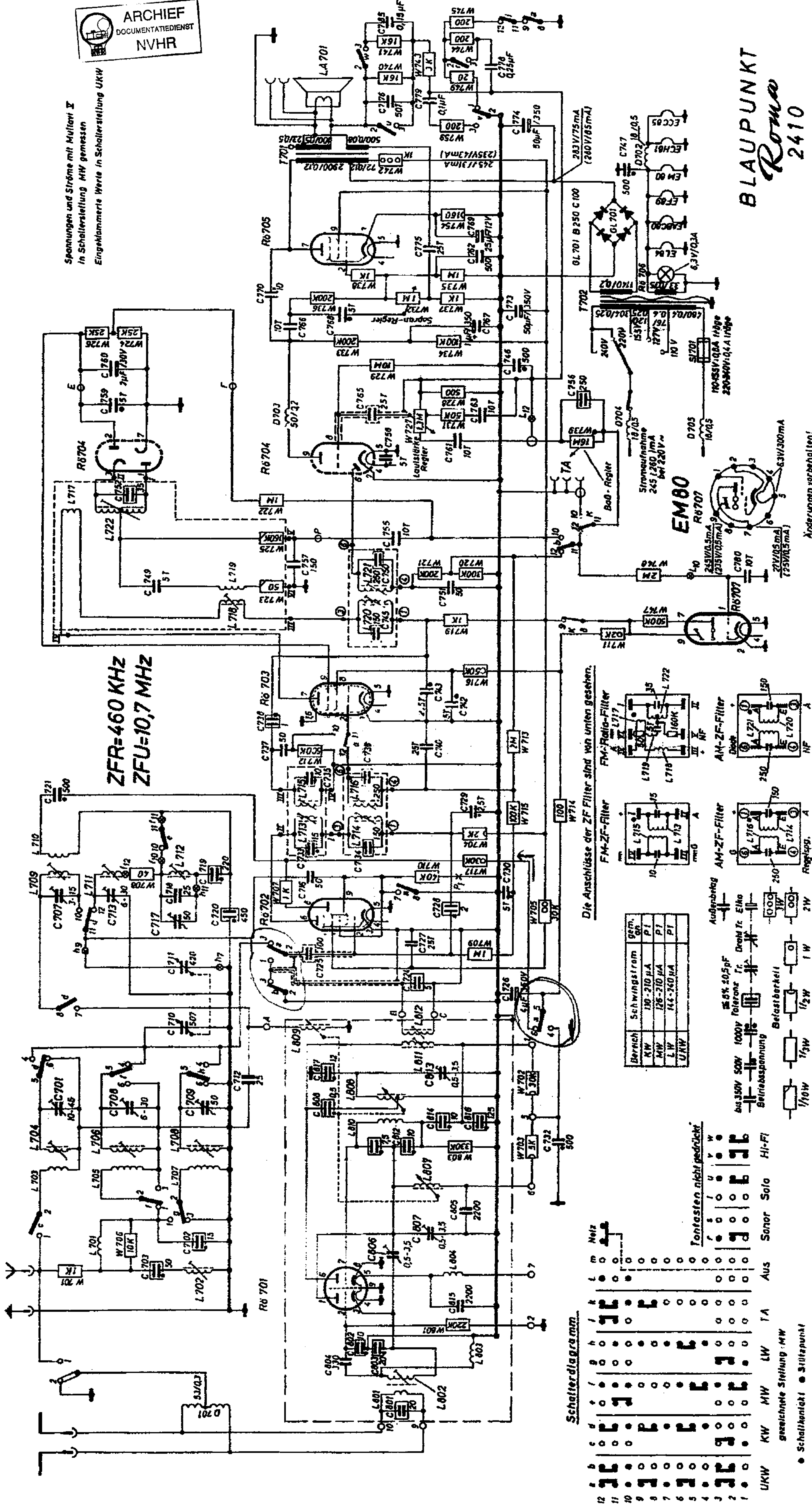
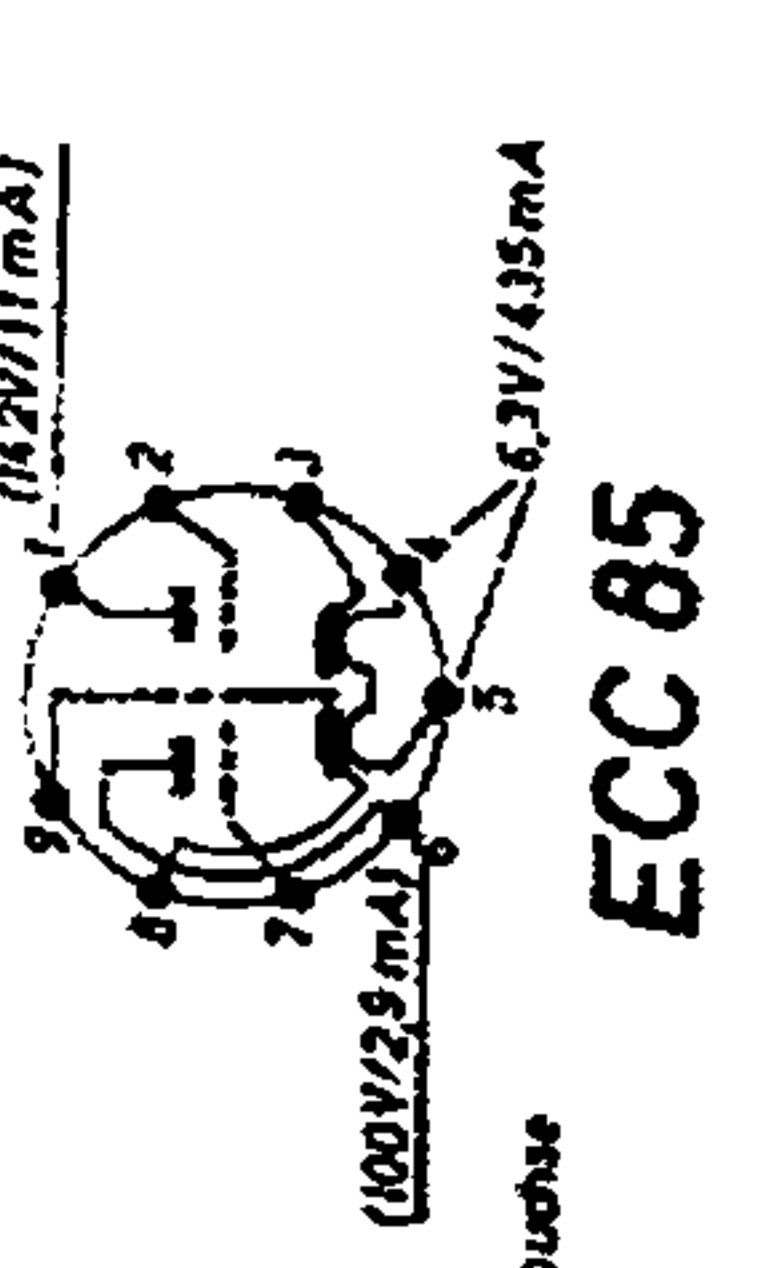
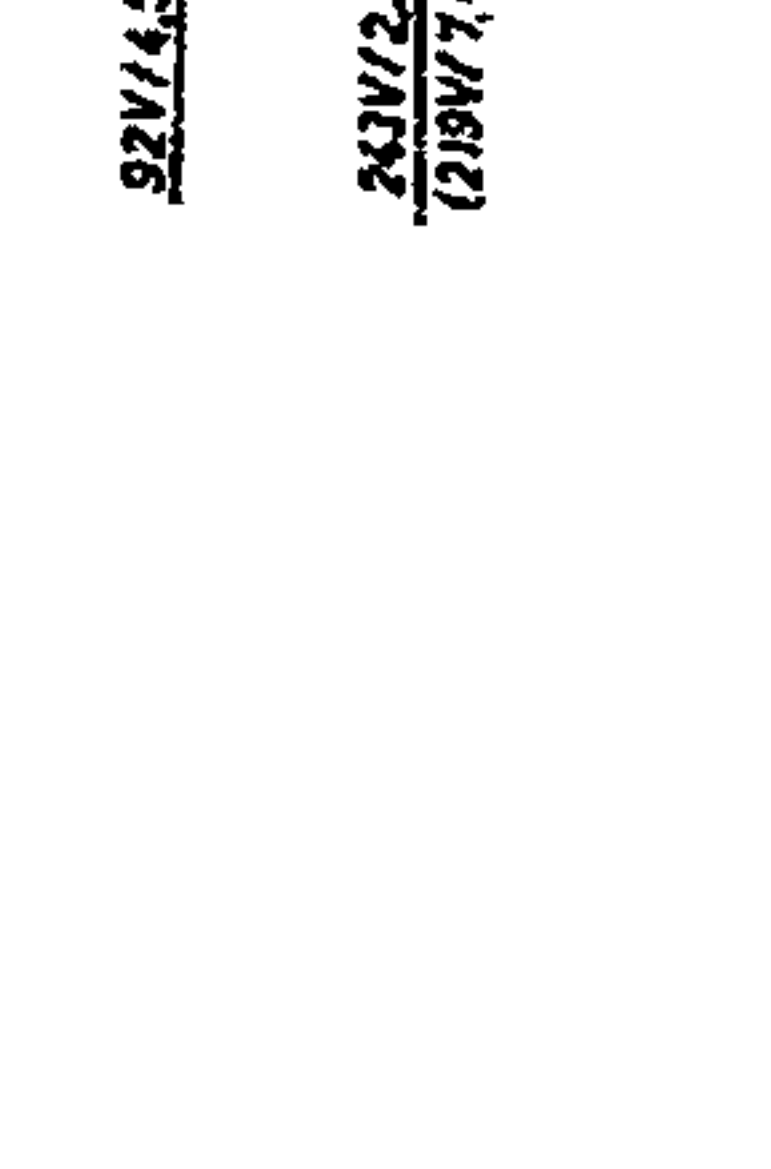
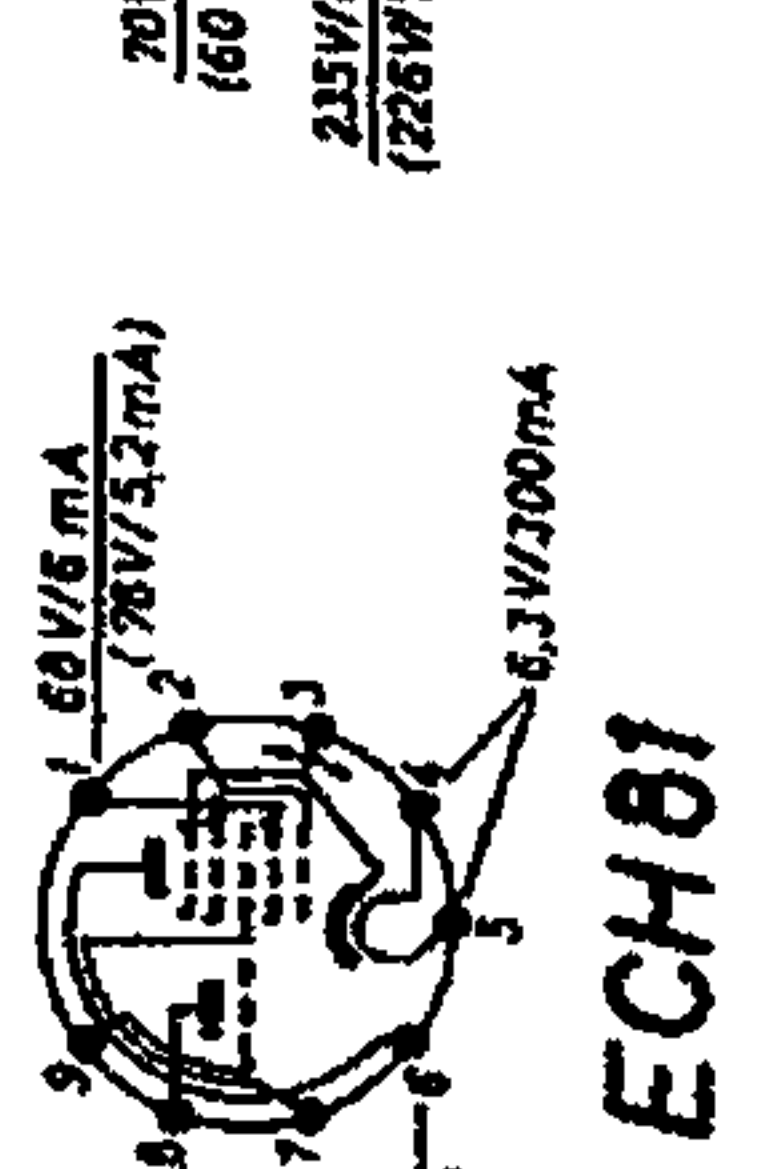
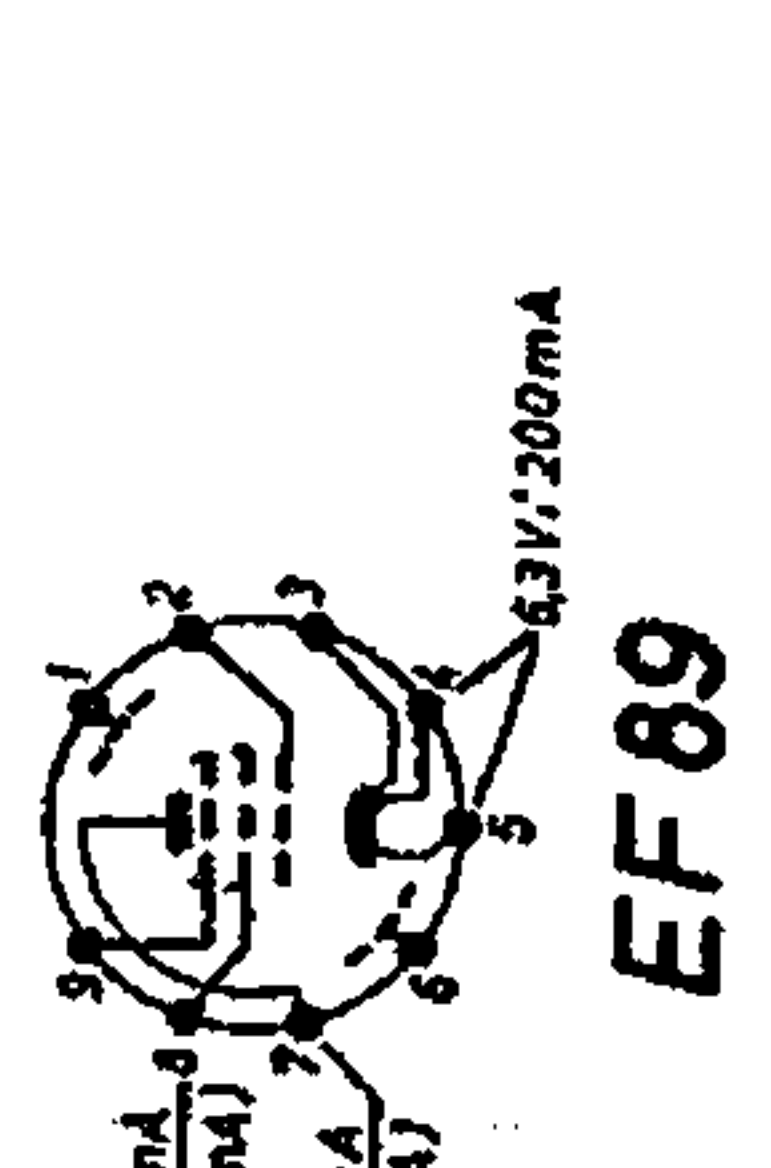
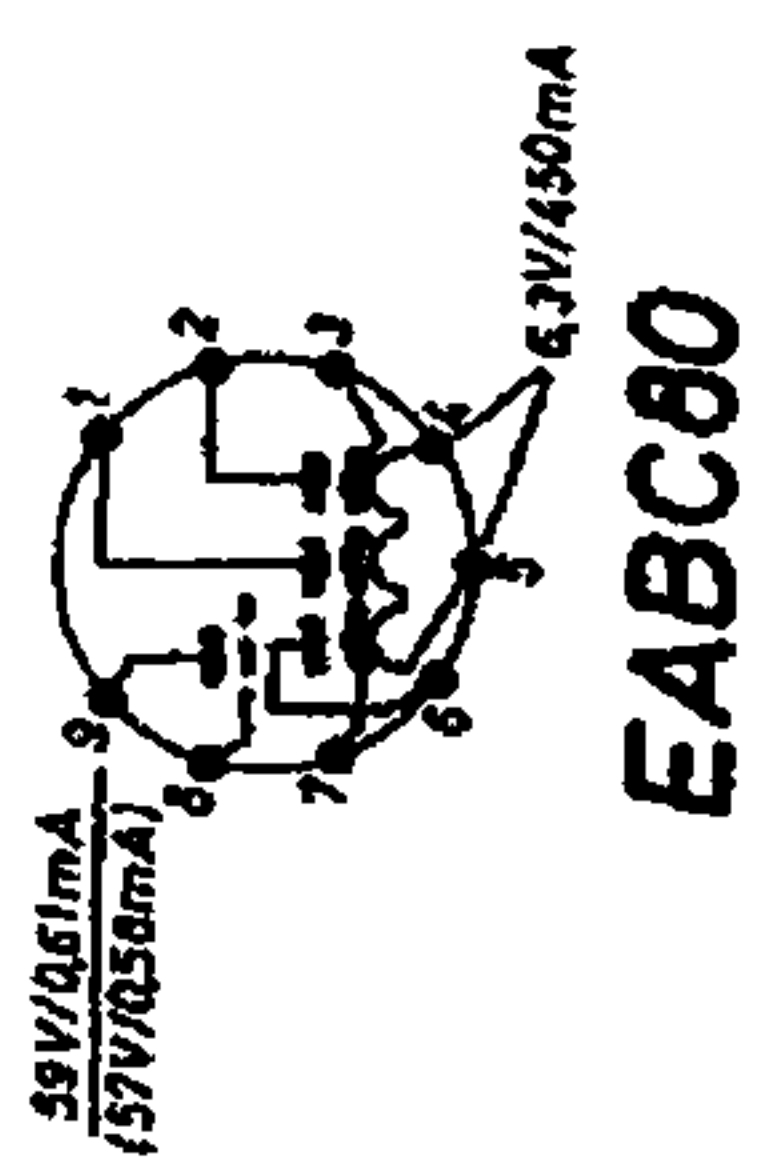
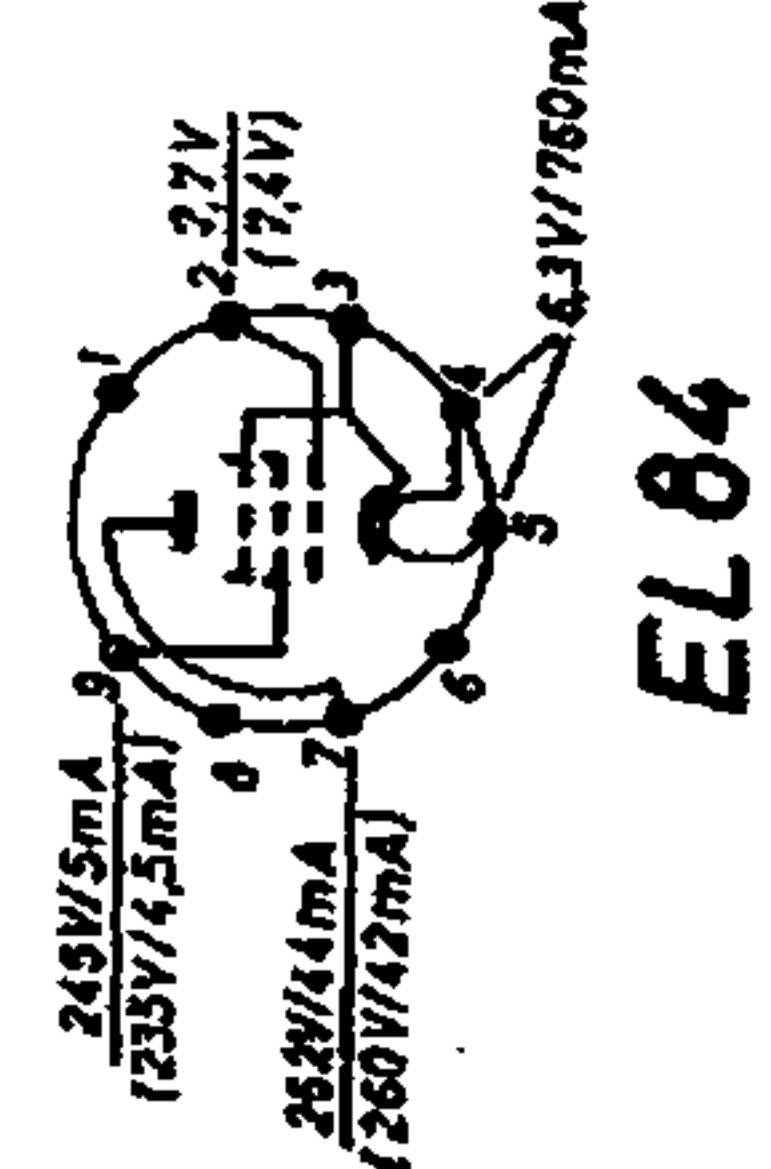

BLAUPUNKT
Roma
2410

Änderungen vorbehalten!