

ZF = 473 kHz

Schalter	a	b	c	d
Rdfk. Wagen				
Rdfk. Kontroll				
Mikrofon				
TA Kontroll				
TA Wagen				

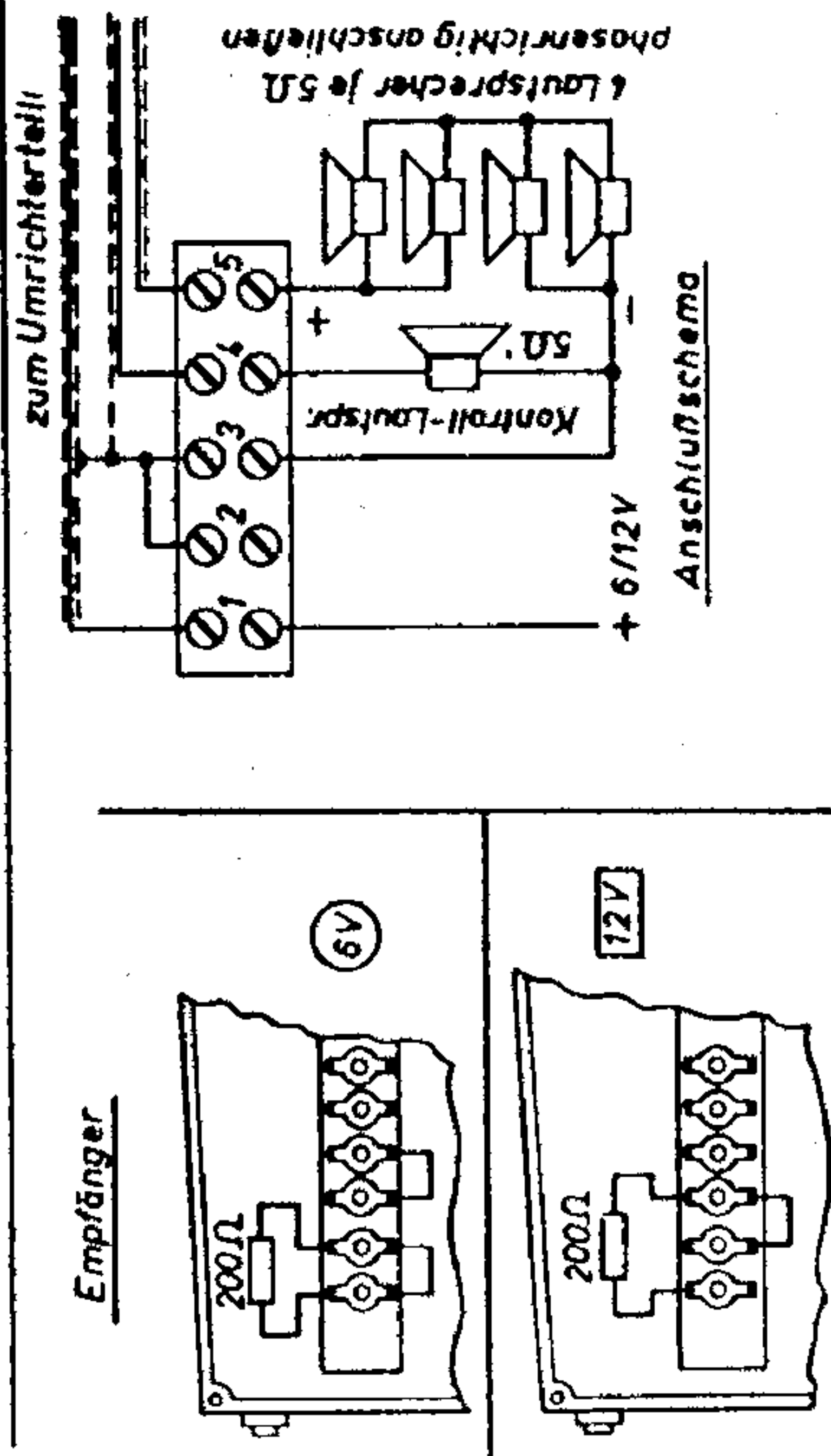
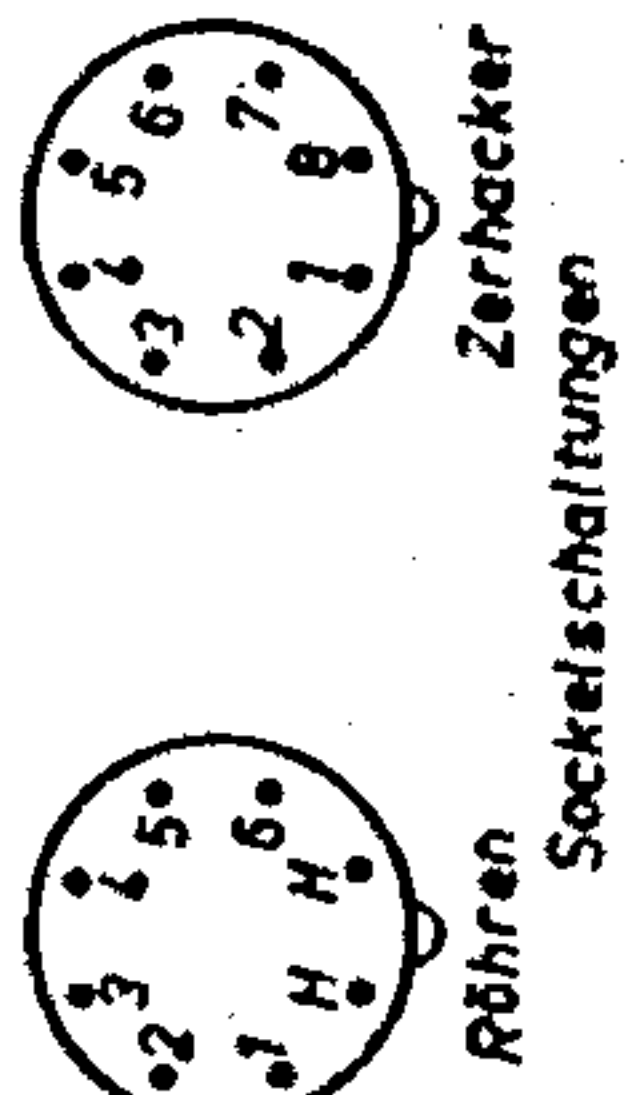

6V = B 800 / 6'
12V = B 822 / 12

6V 12V
Schaltung

Abgleichanweisung } wie bei Gerät : Solitude 3
Umrichter oben umlenken (Nr. 23567 bis 25274)

(ab Nr. 50558)

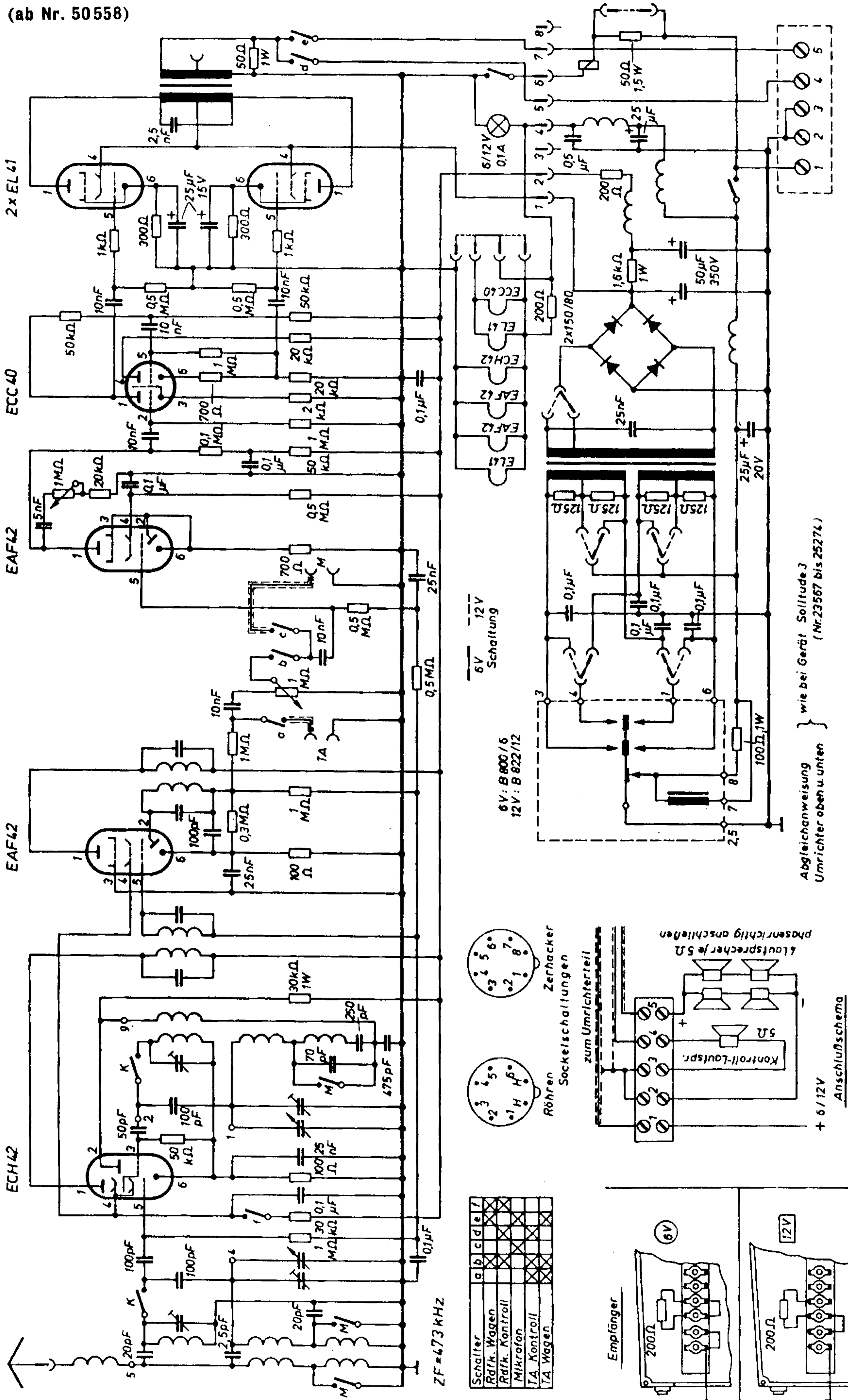

Schalter	a	b	c	d	e	f
Rafk. Wagen						
Rafk. Kontroll						
Mikrofon						
TA Kontroll						
TA Wagen						

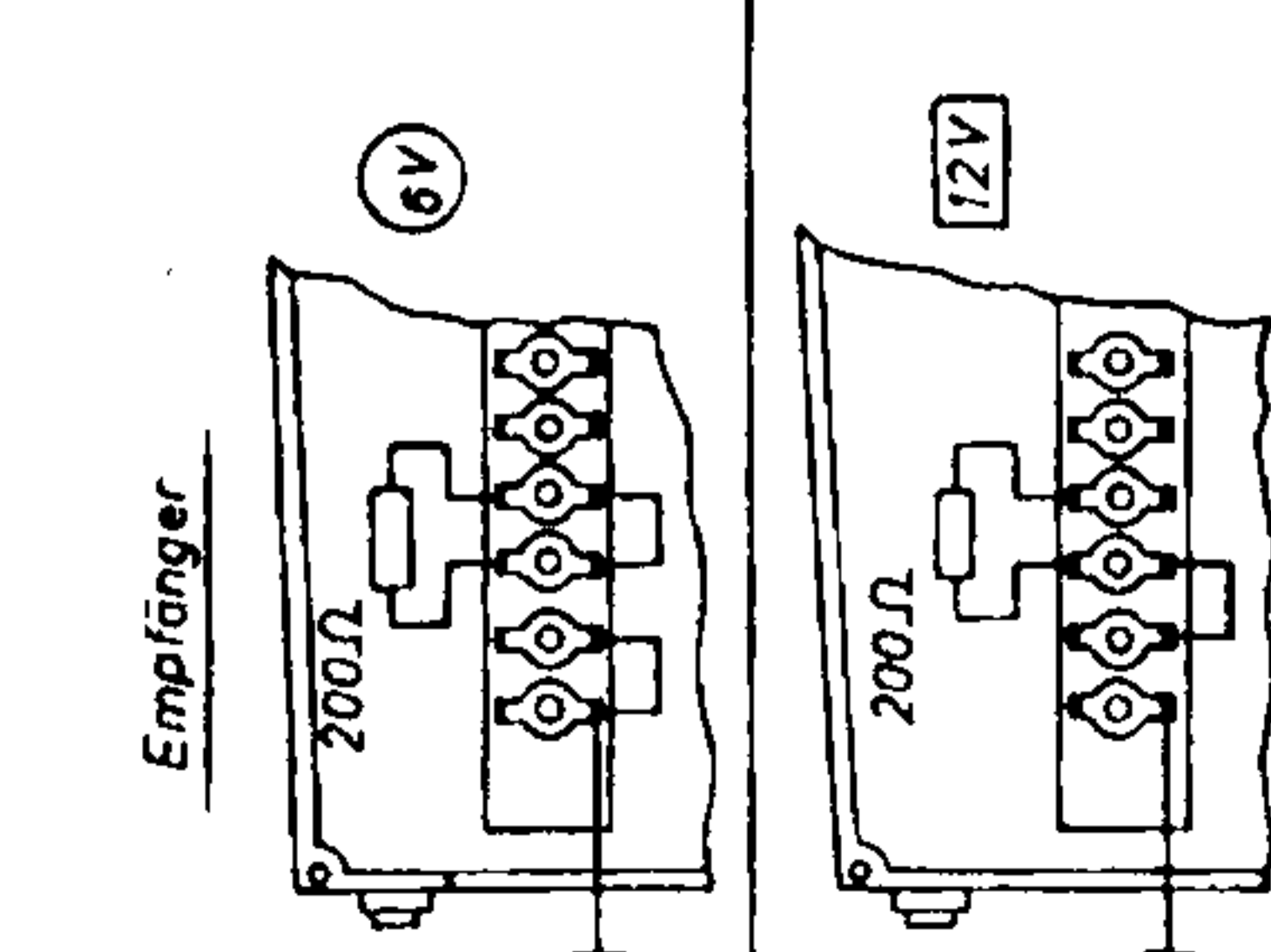
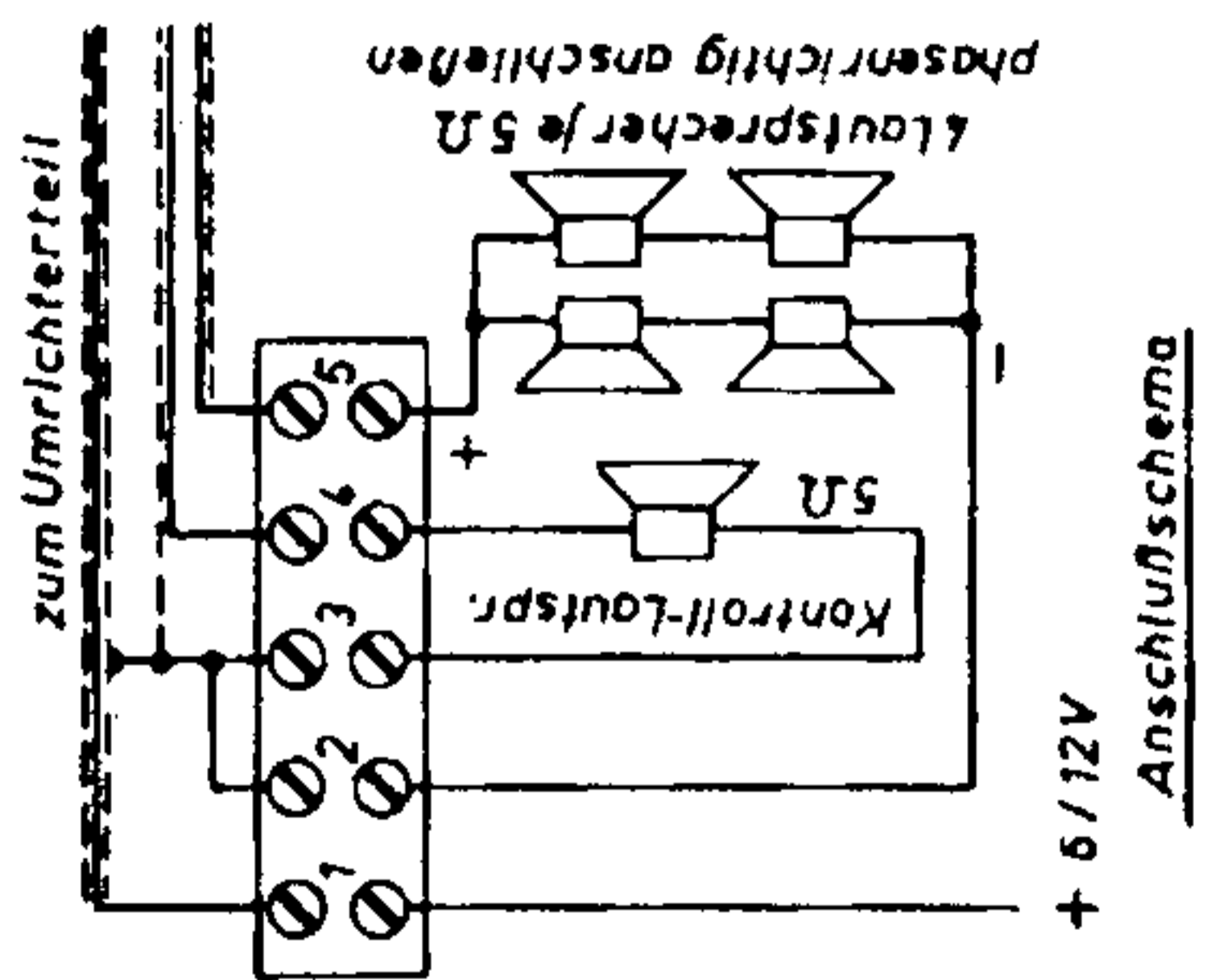
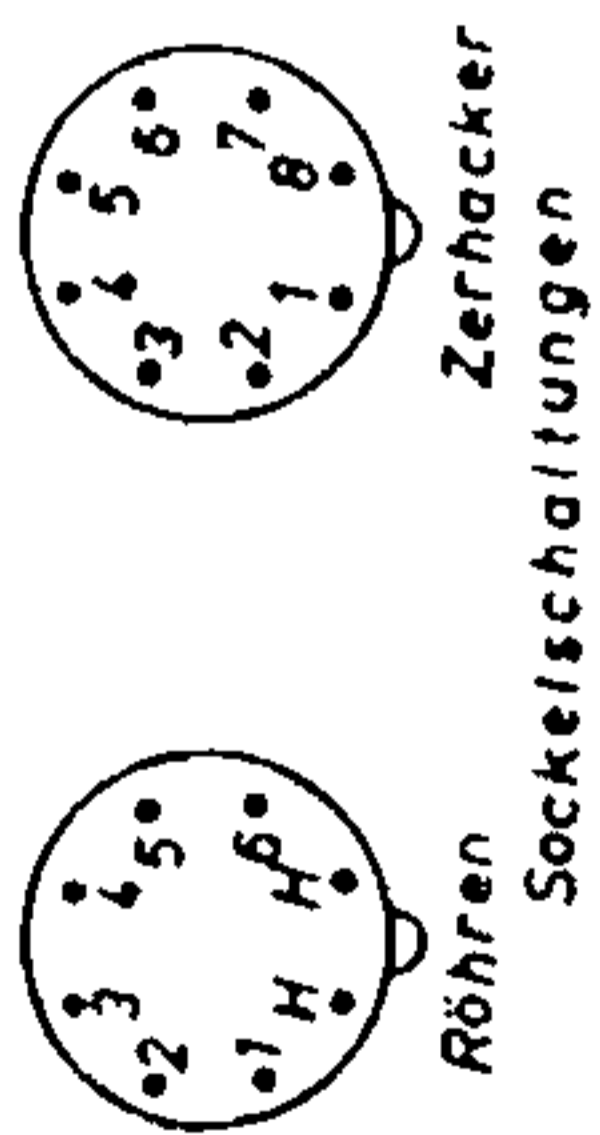

6V: B 800/6
12V: B 822/12

Schaltung

Abgleichanweisung } wie bei Gerät Solitude 3
Umrichter oben u. unten (Nr. 23567 bis 25276)

2 x EL41

ECC40

EAF42

EAF42

ECH42

ZF = 473 kHz

+ 6/12V

Becker Schauinsland

(ab Nr. 50665)

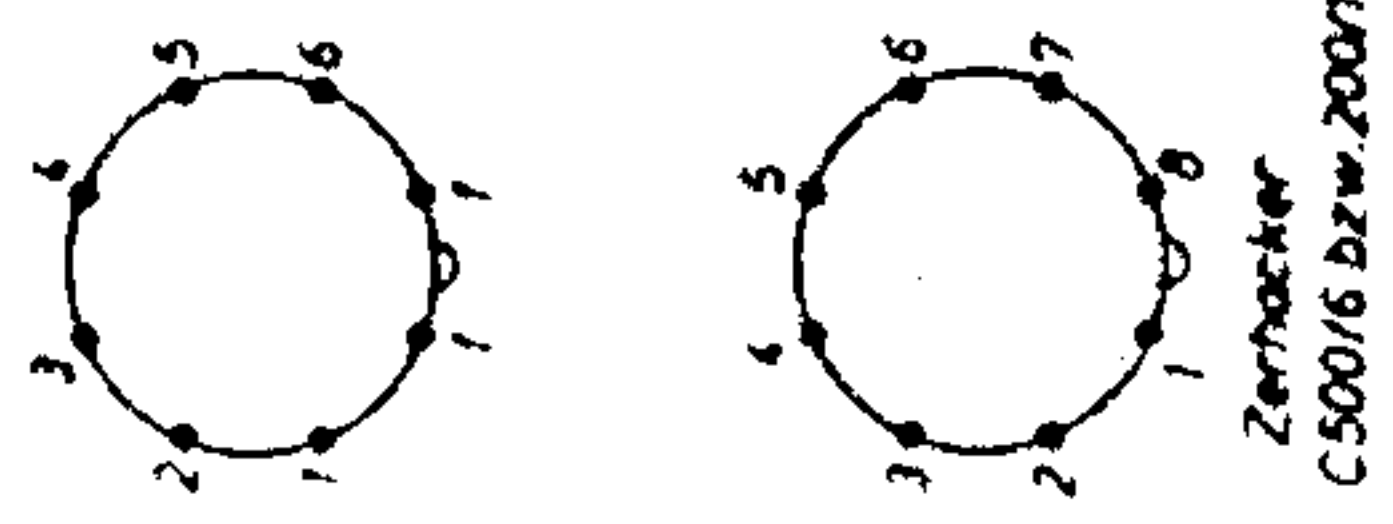

Schalter	a	b	c	d	e	f
Rundf. Wagen						
Rundf. Kontrolle						
Mikrofon						
Tonebn. Kontrolle						
Tonebn. Wagen						

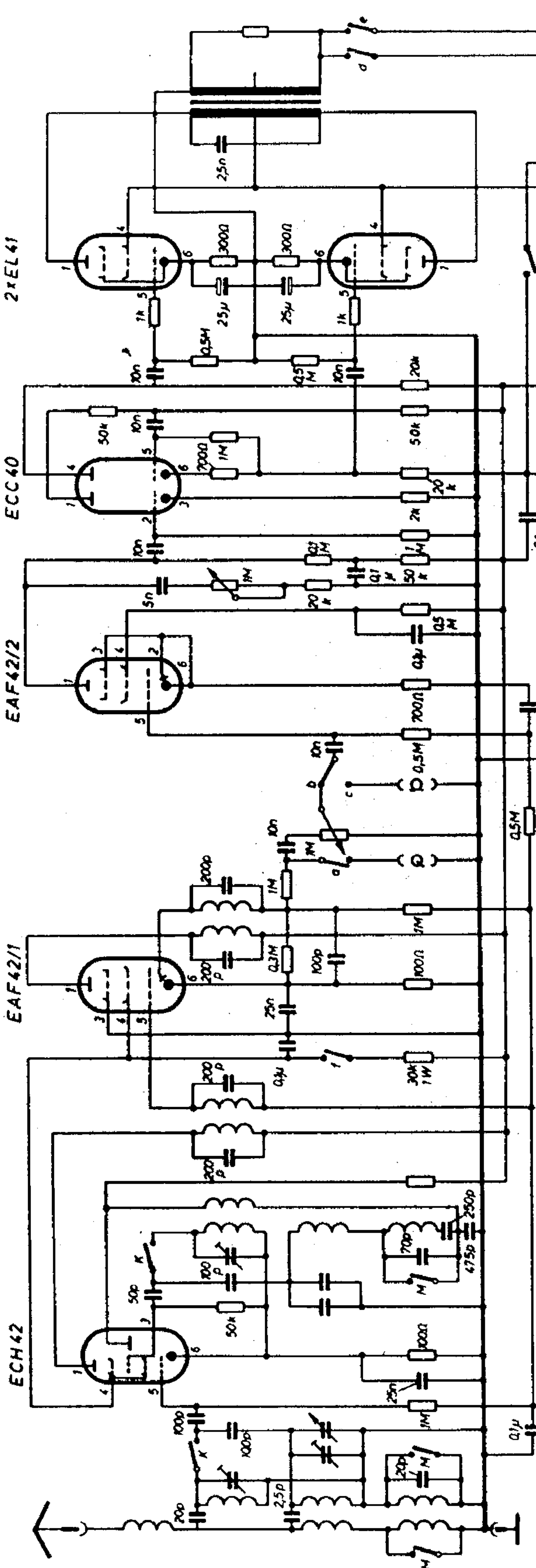

ZF = 473 (455) kHz

