

AEG Visavox FE 653 TF/3D

(linke Seite des Schaltbildes)

EF80/2

EF80/3

PL83

ECC82/1

MW53-80

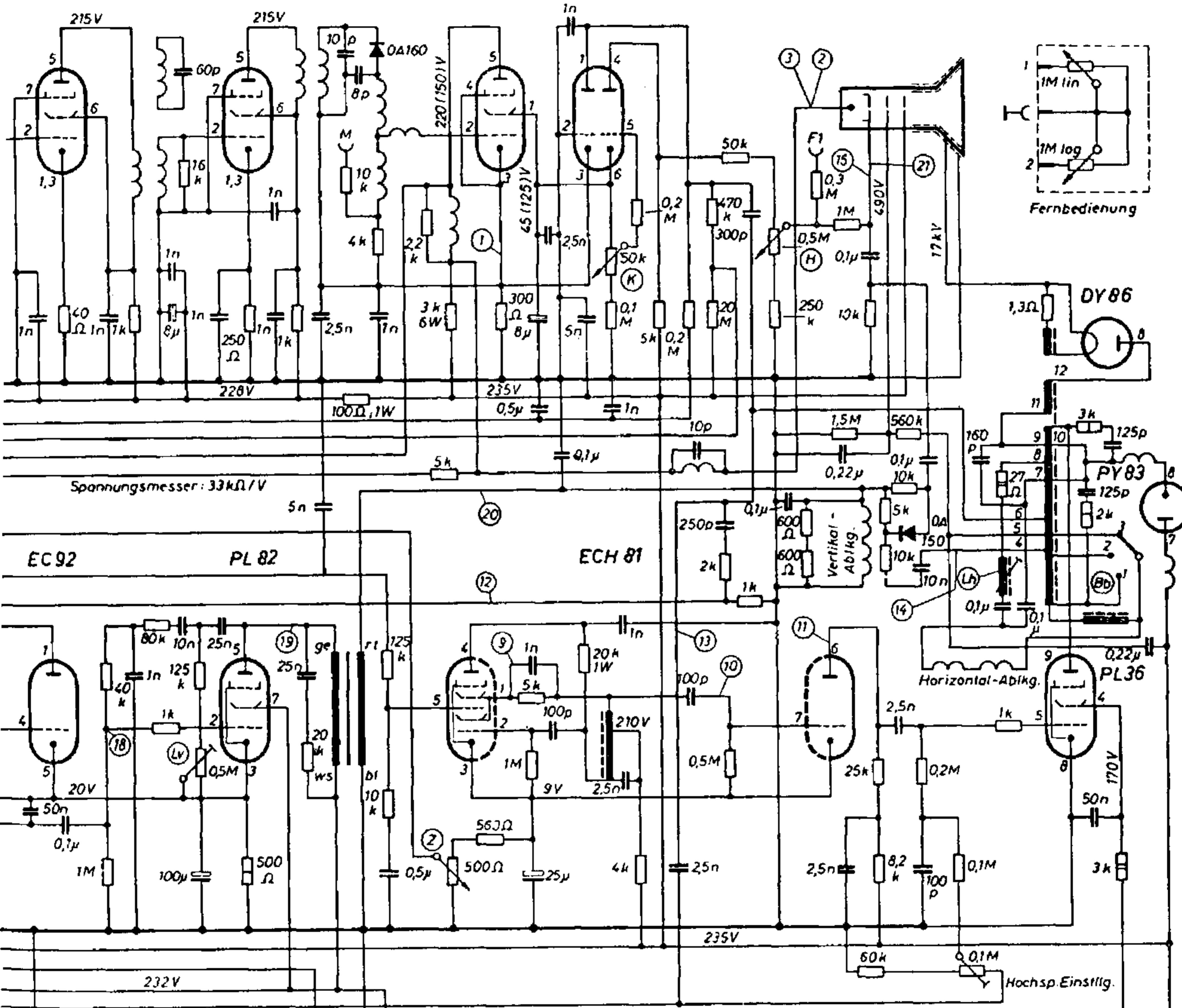

EC92

PL82

ECH81

232V

235V

Hochsp. Einstllg.

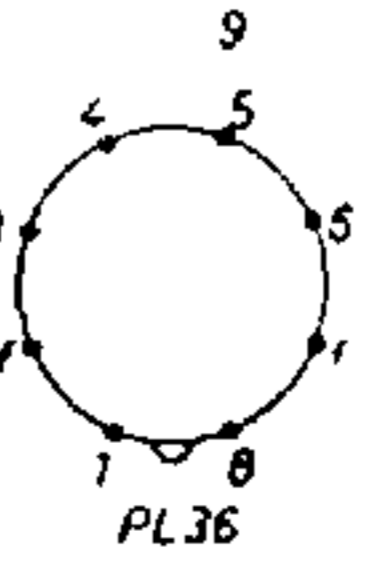
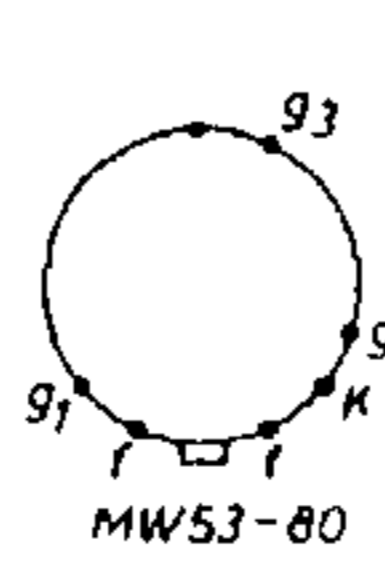
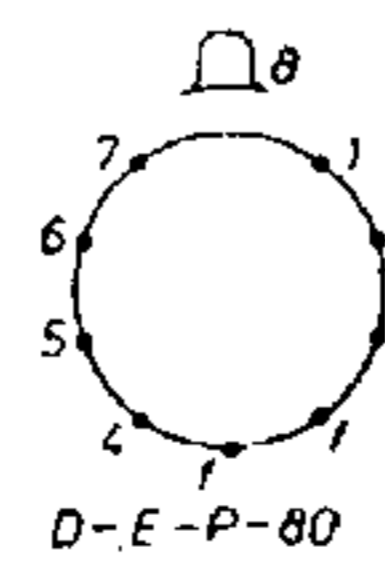
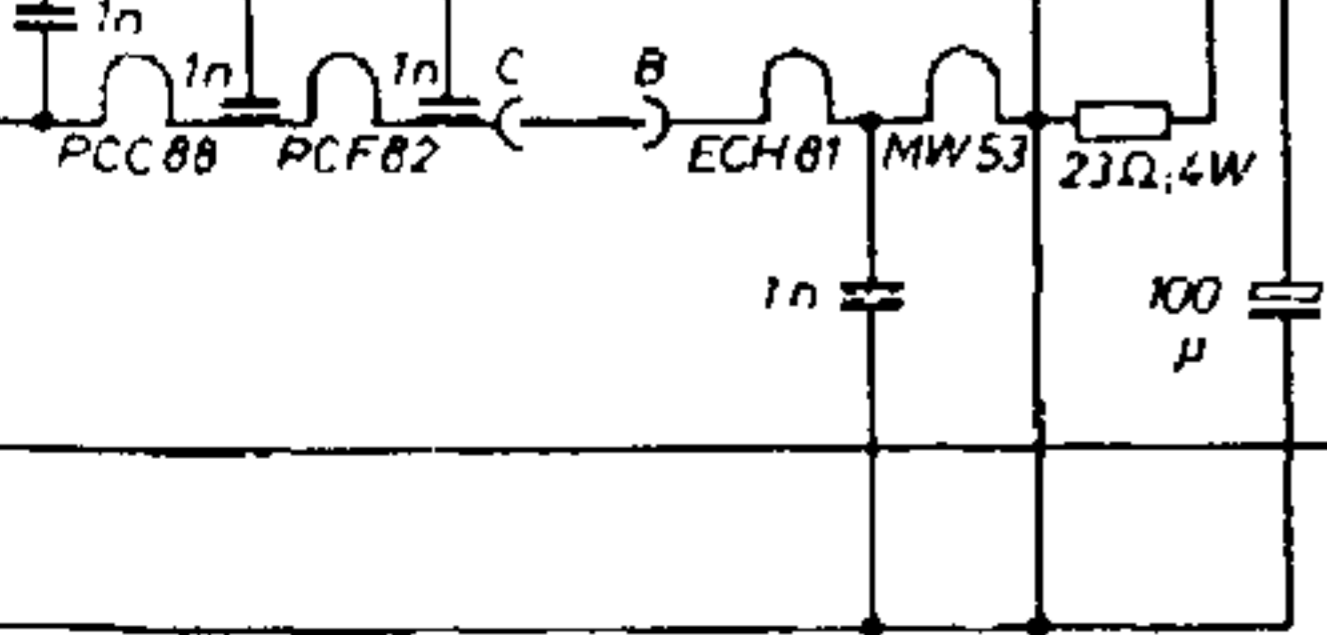

Sackschaltungen

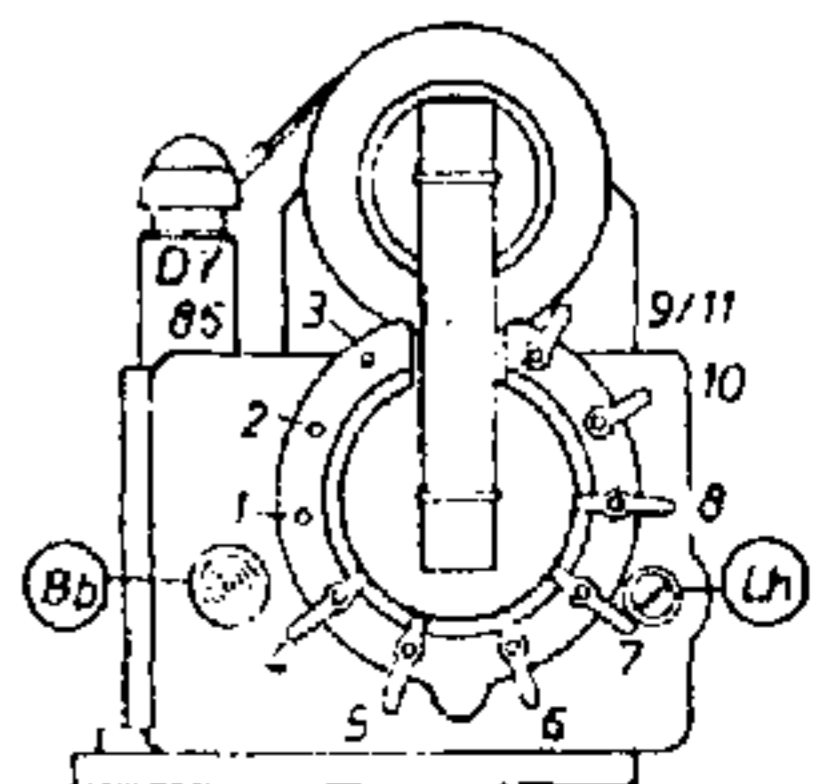

Anschlüsse des Zeittransformators

AEG Visavox FE 653 TF/3D

(rechte Seite des Schaltbildes)

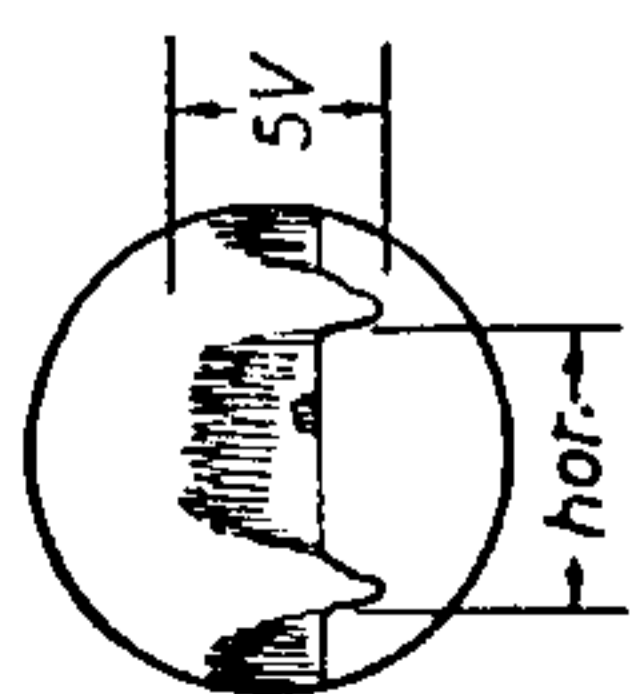

1

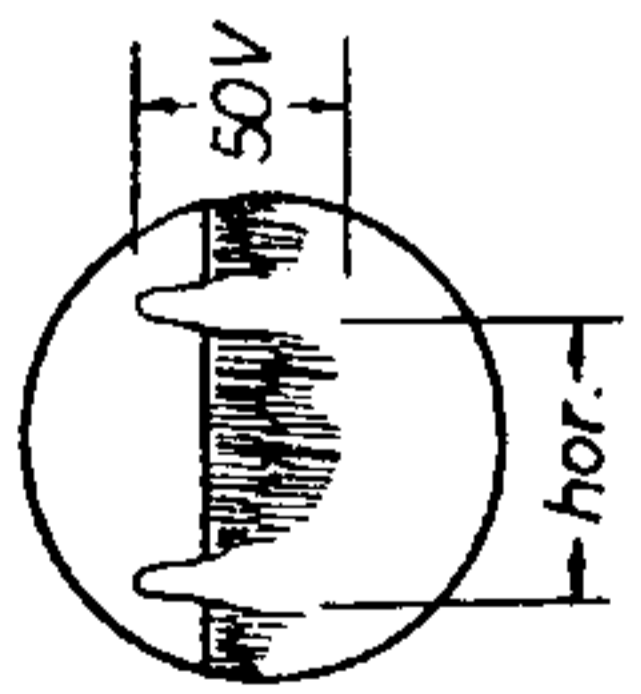

2

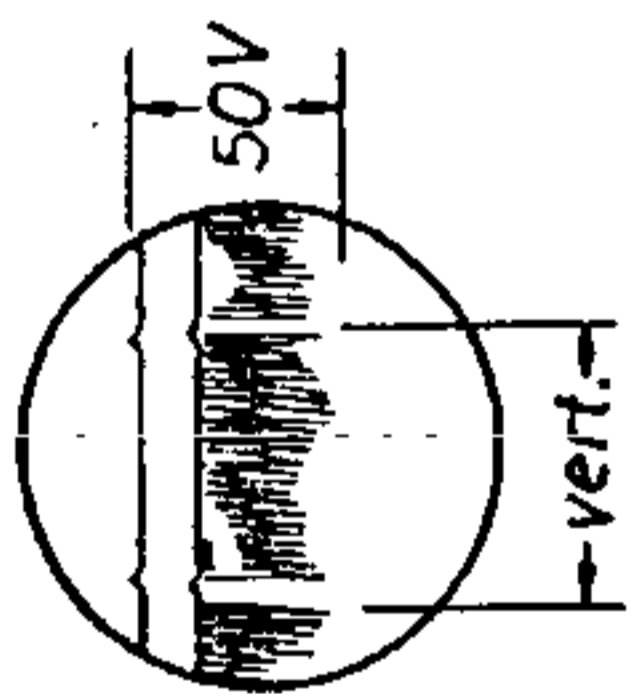

3

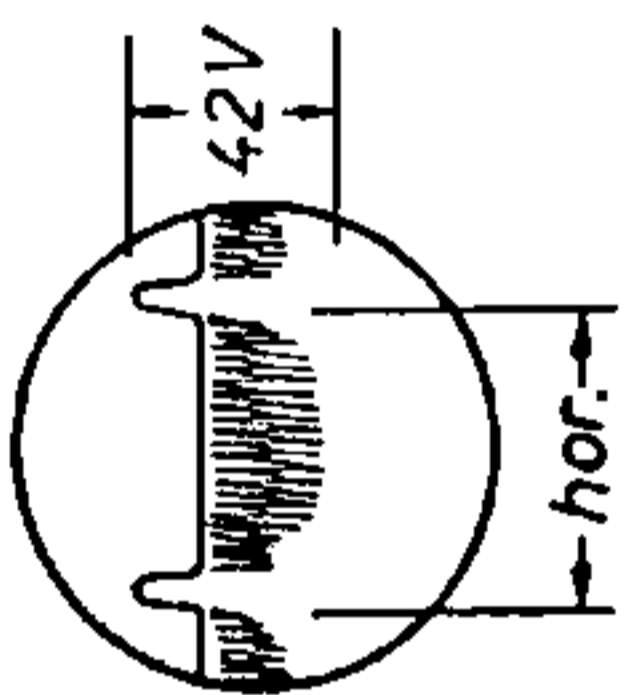

4

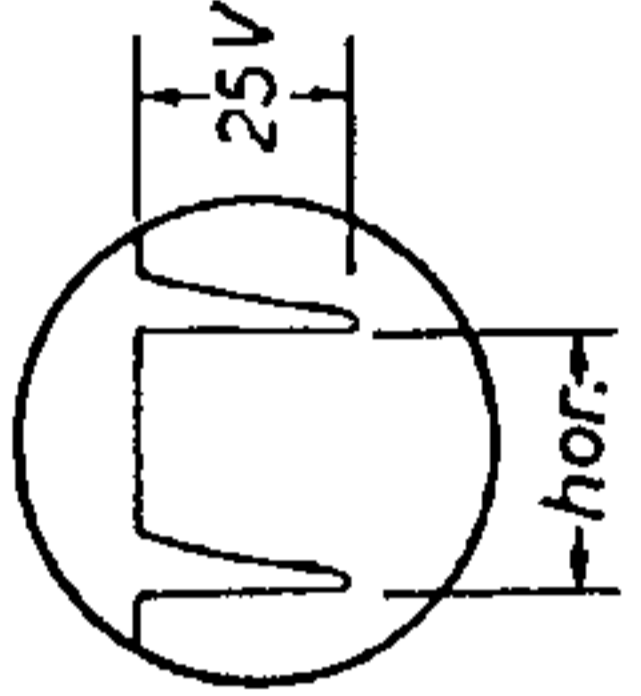

5

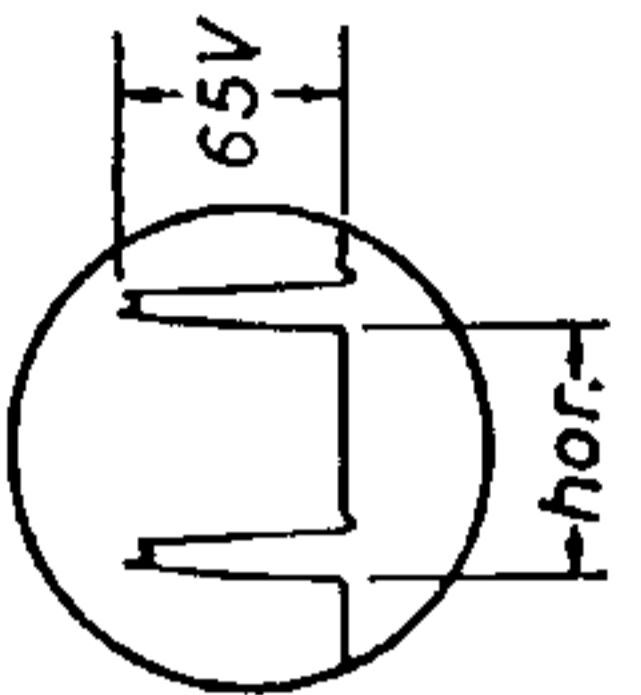

6

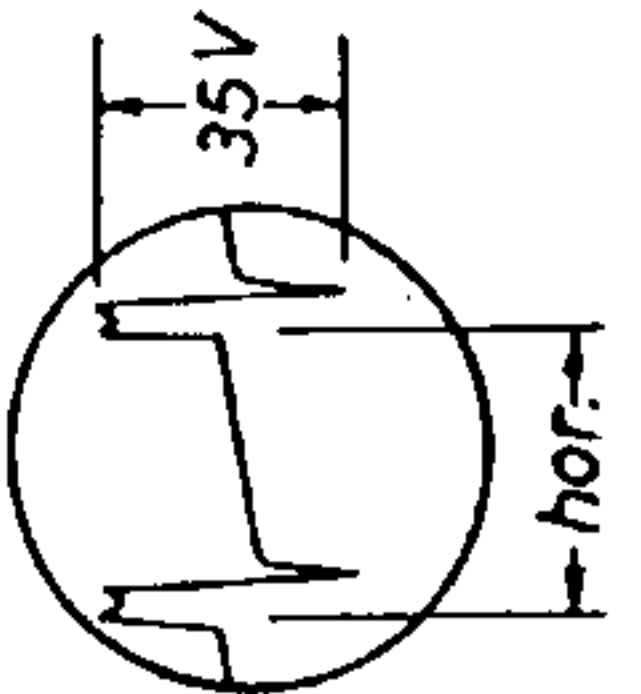

7

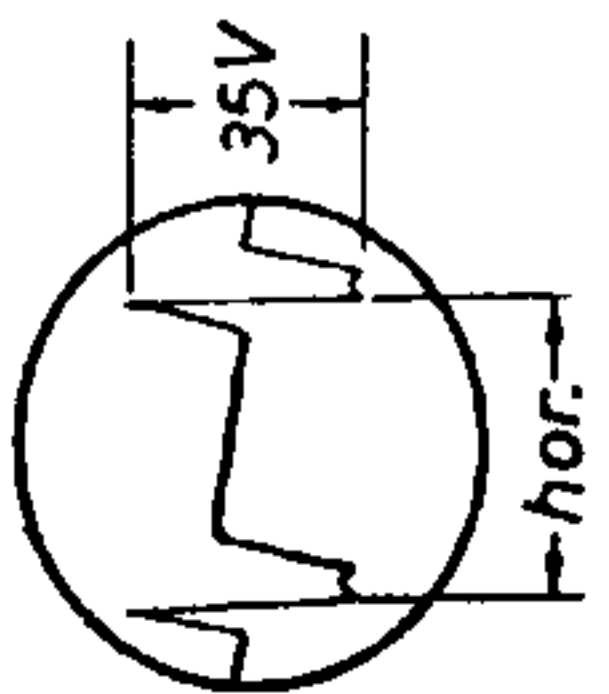

8

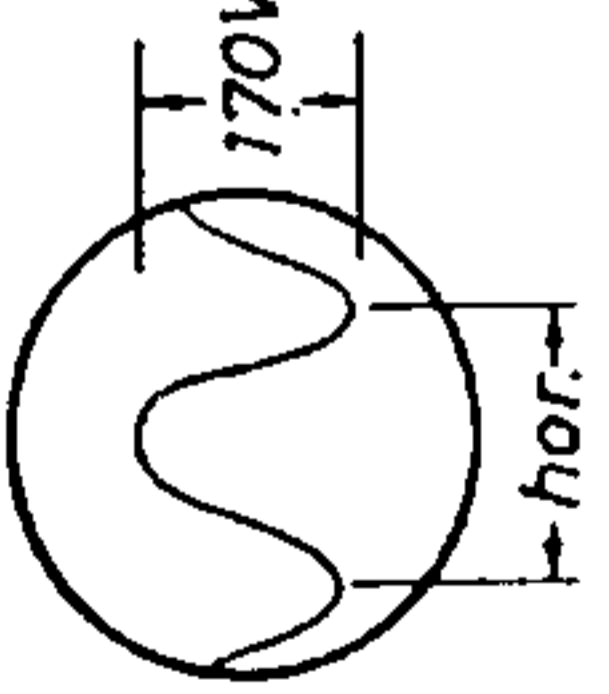

9

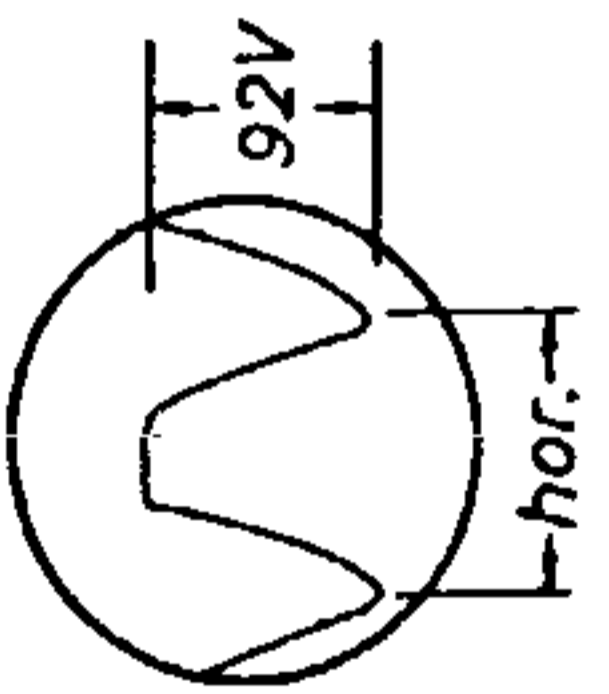

10

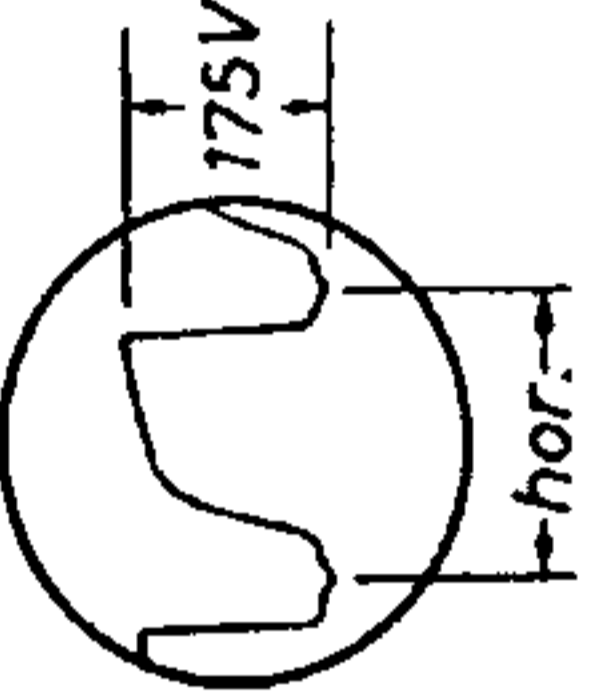

11

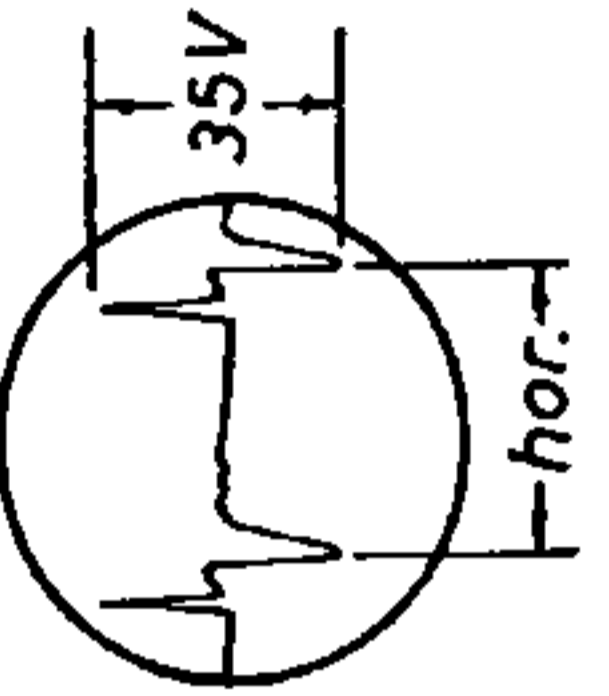

12

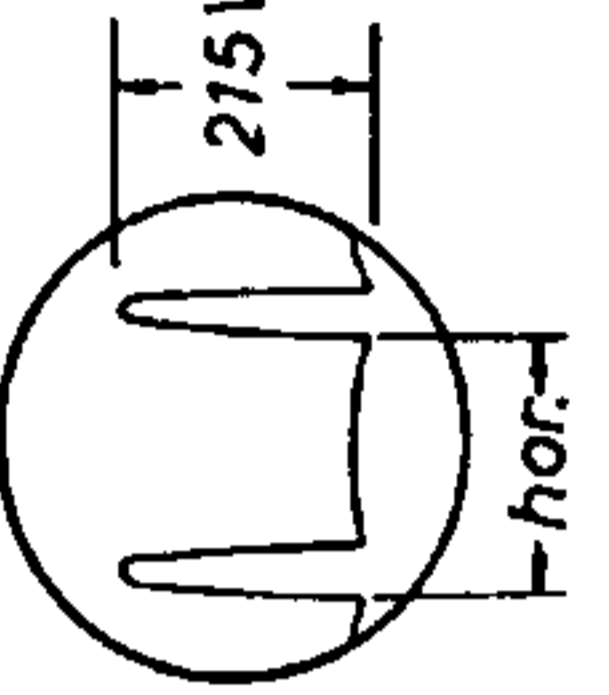

13

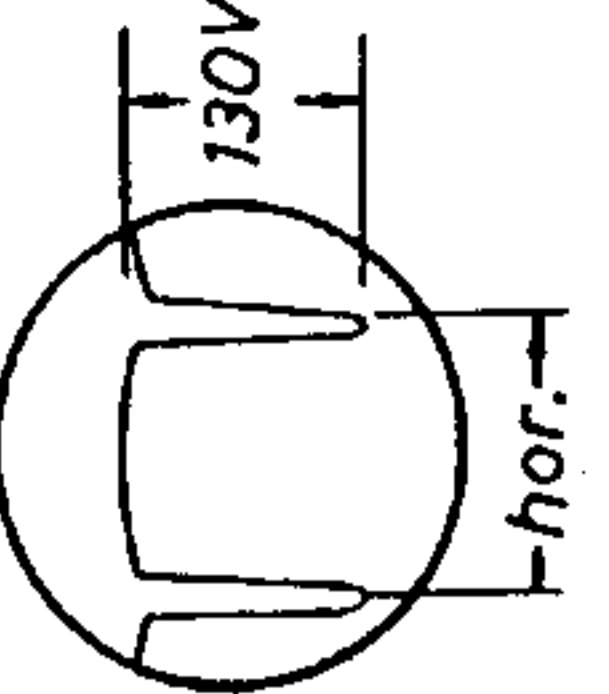

14

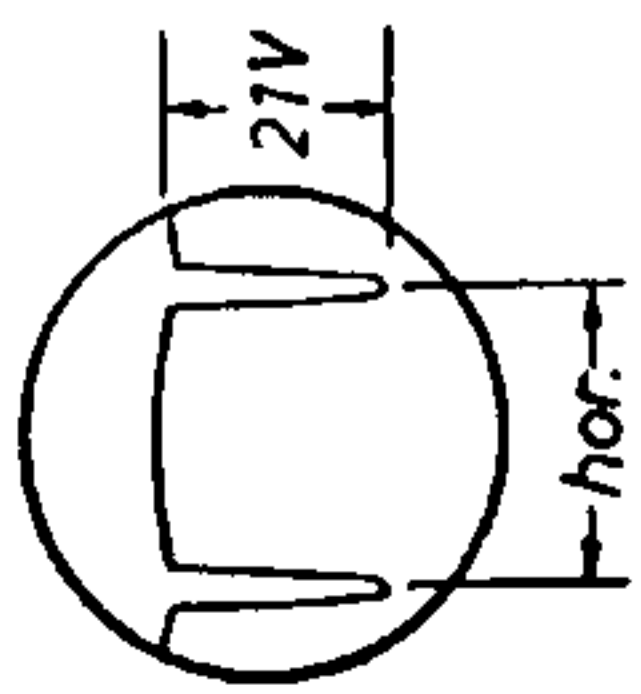

15

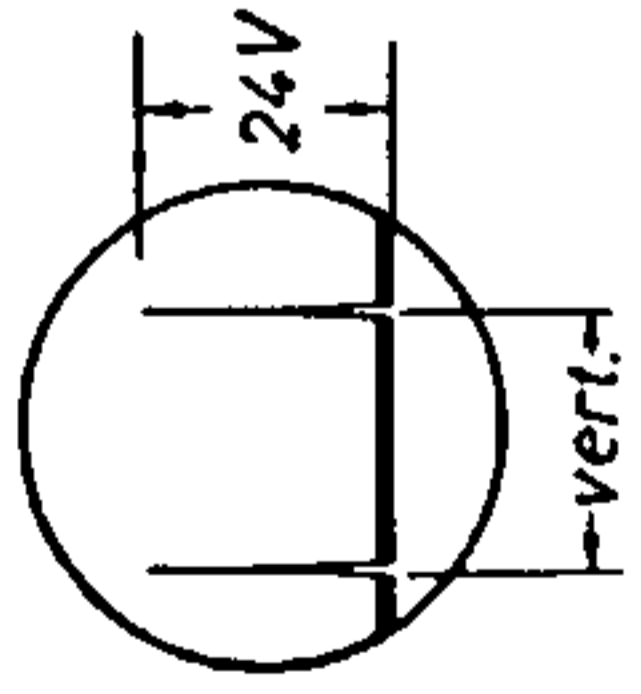

16

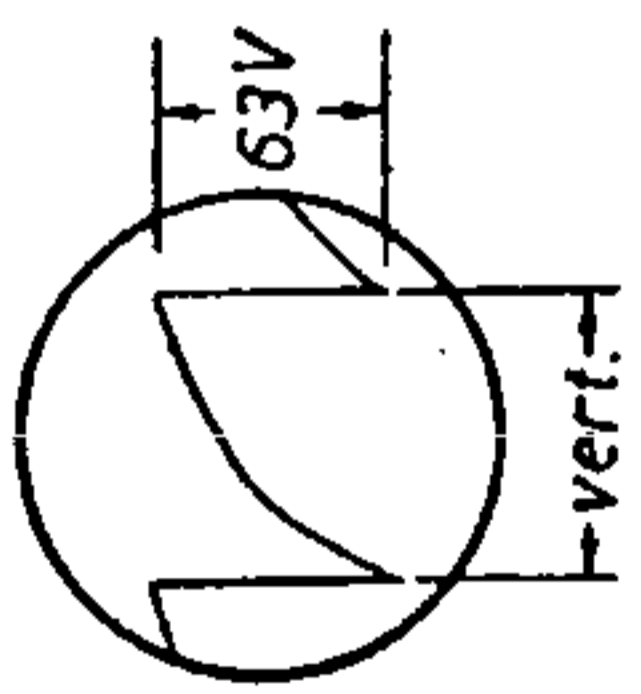

17

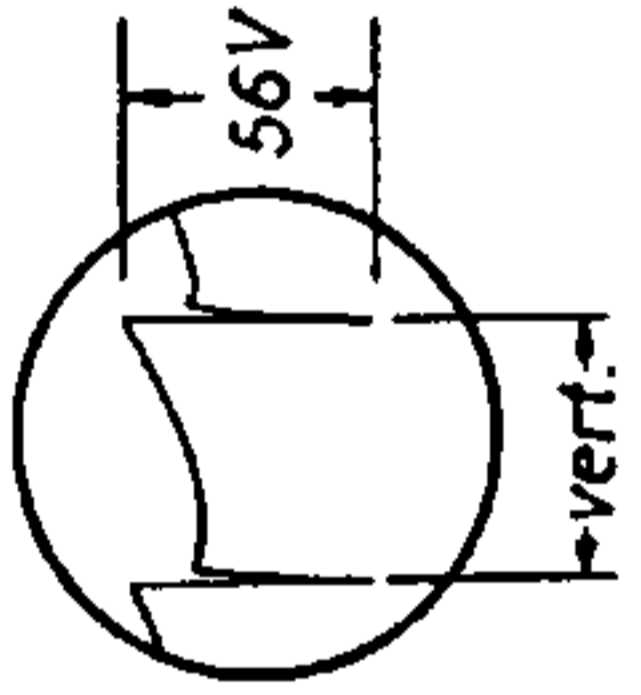

18

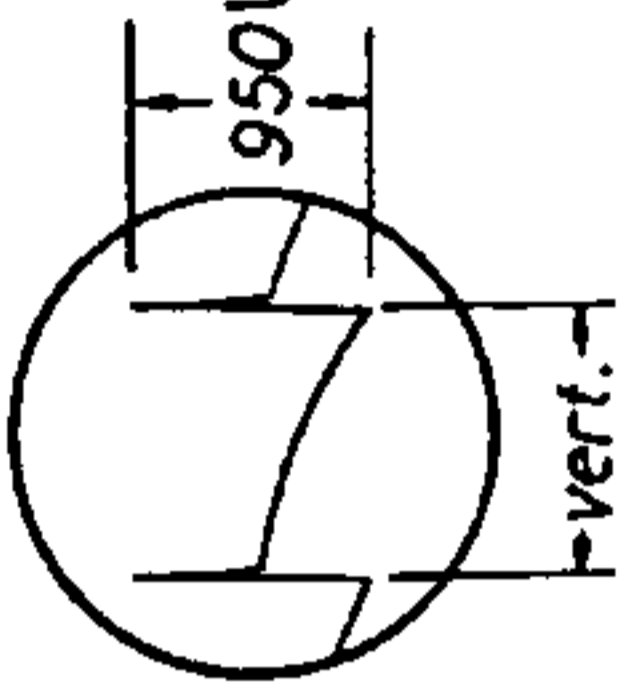

19

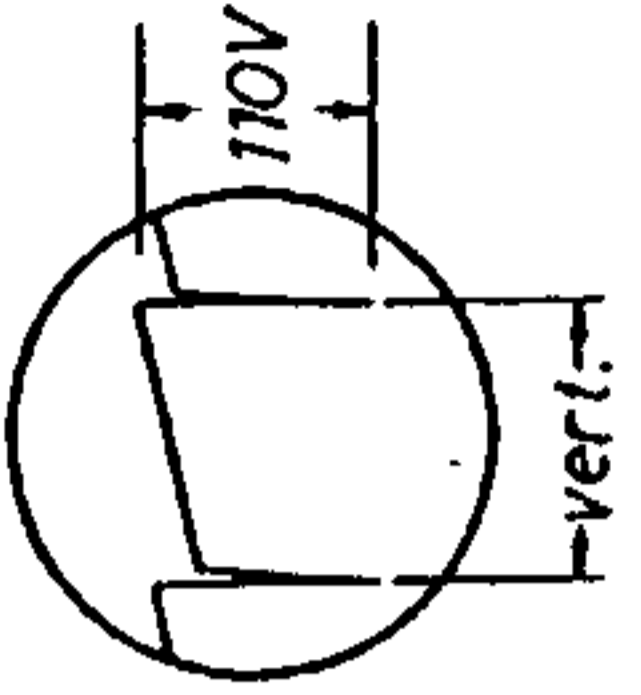

20

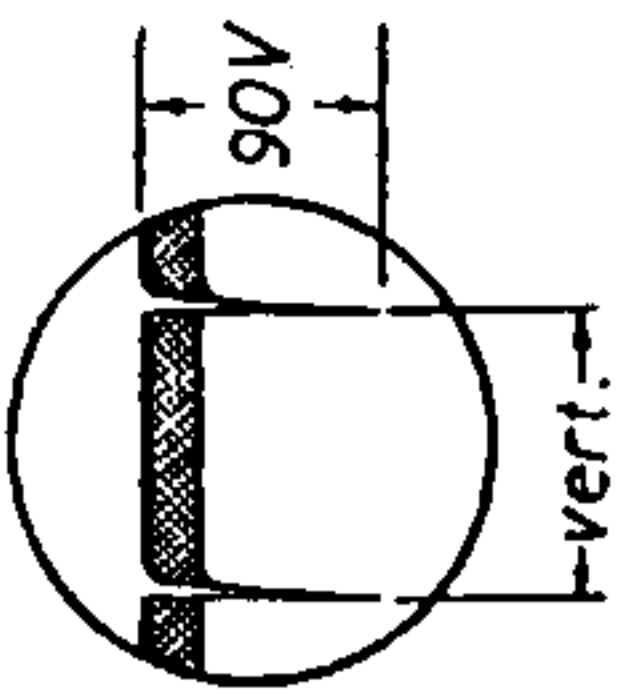

21