

M: Meßpunkt  
F: Anschluß für Fernbedienung

PCL 81

ECH 81

DY 80

PY 83

PL 81

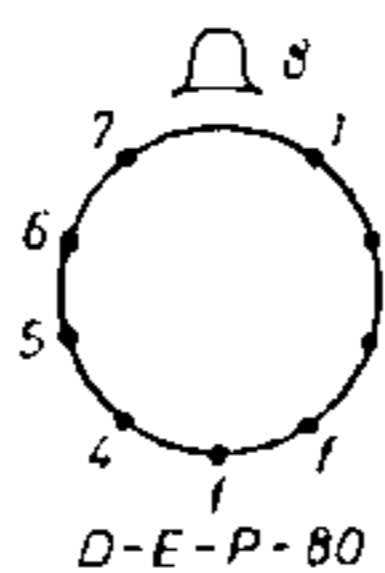

D-E-P-80

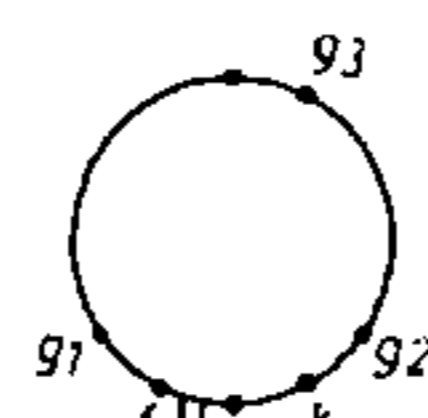

MW43-64

Sockettschaltungen

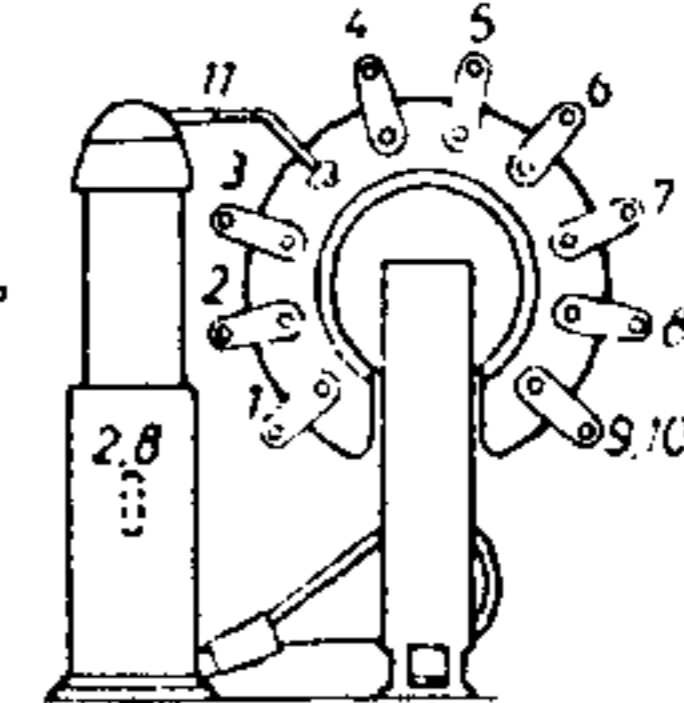

Horizontal-Ablenk- und Hochspannungseinheit

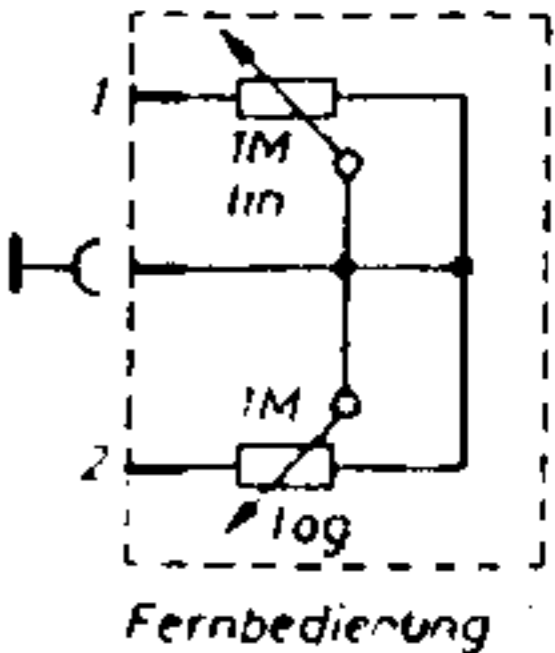

Fernbedienung

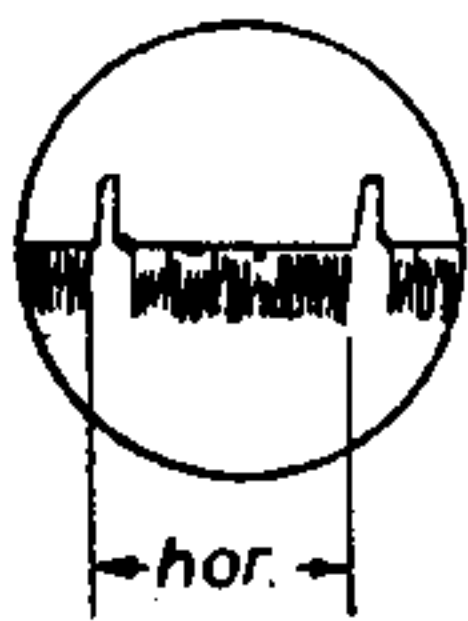

1

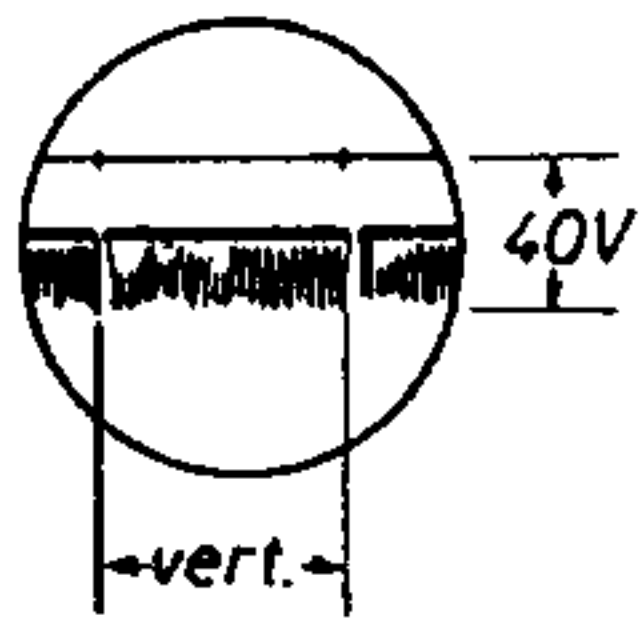

2

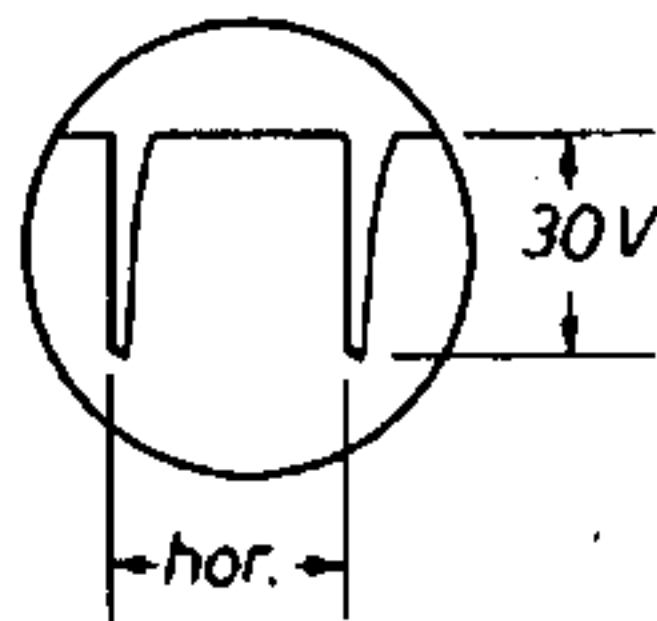

3

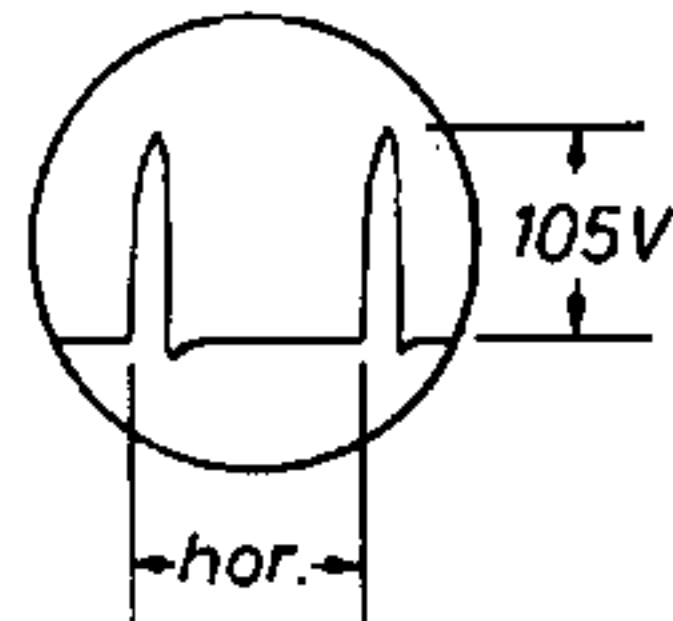

4

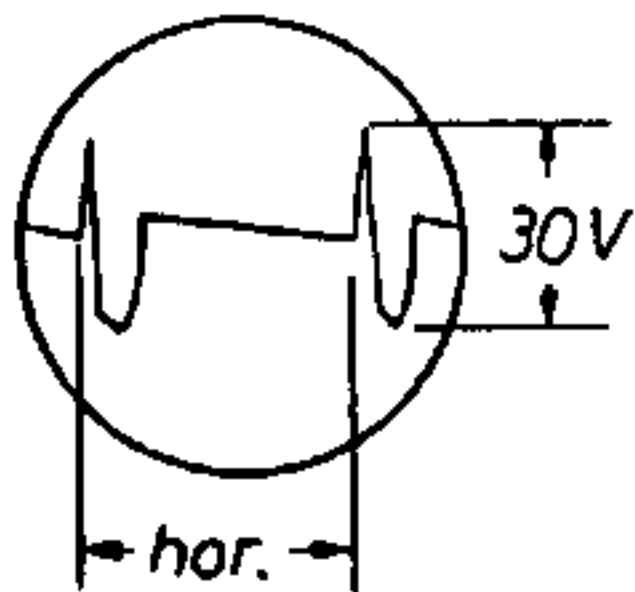

5

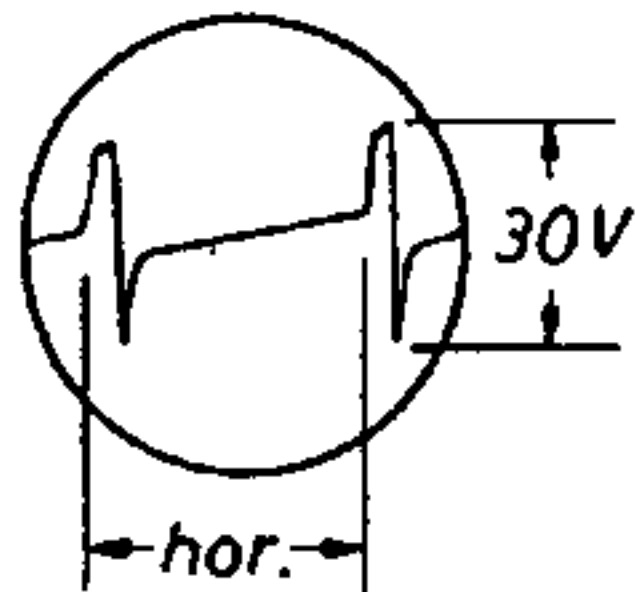

6

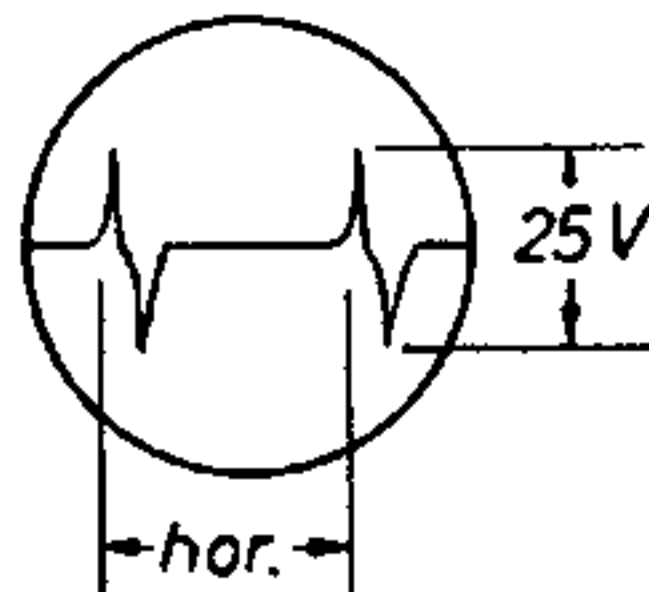

7

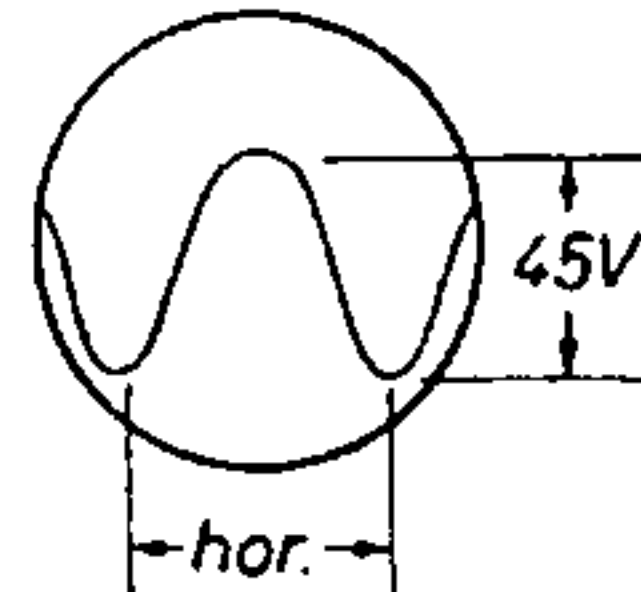

8

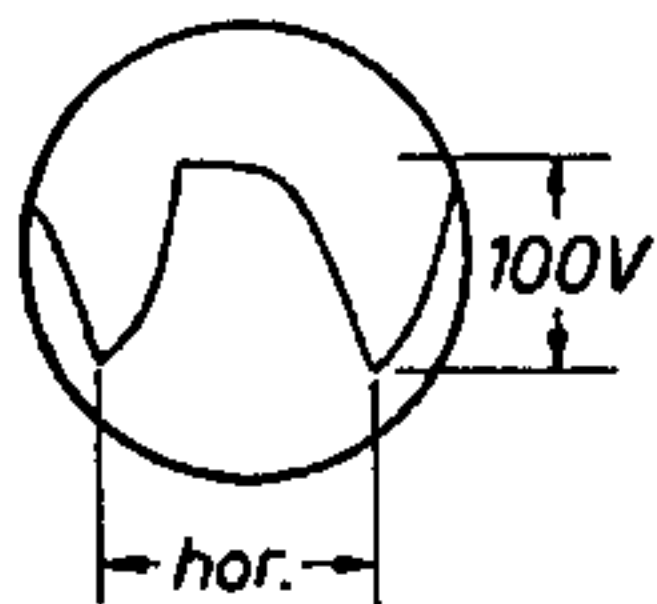

9

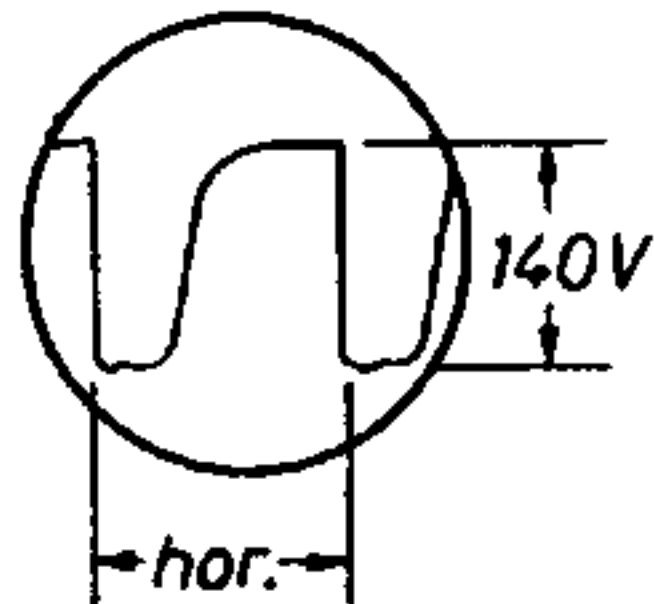

10

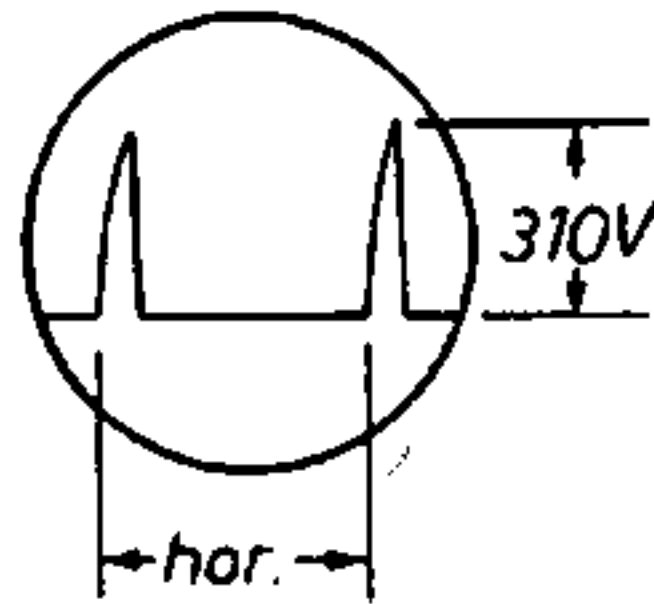

11

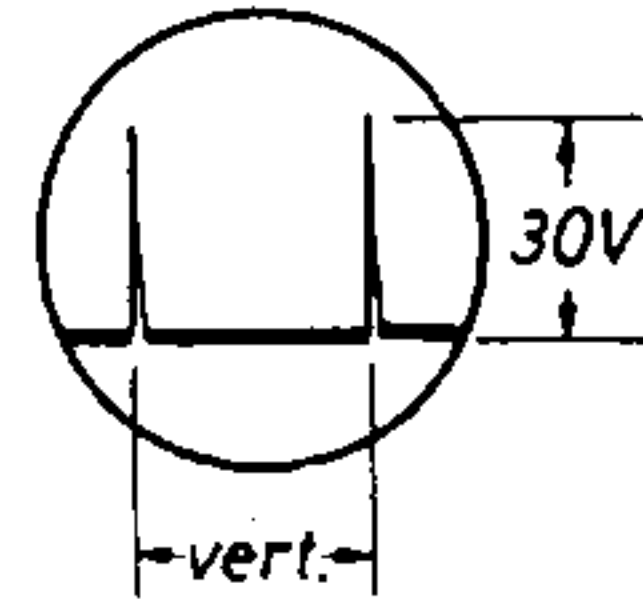

12

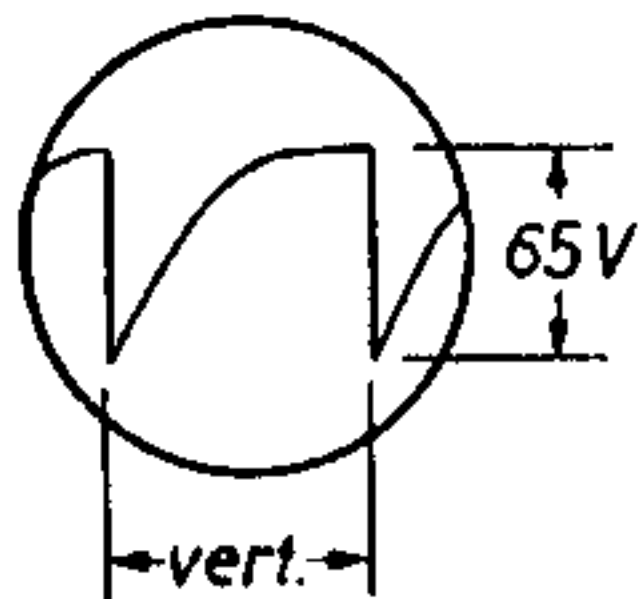

13

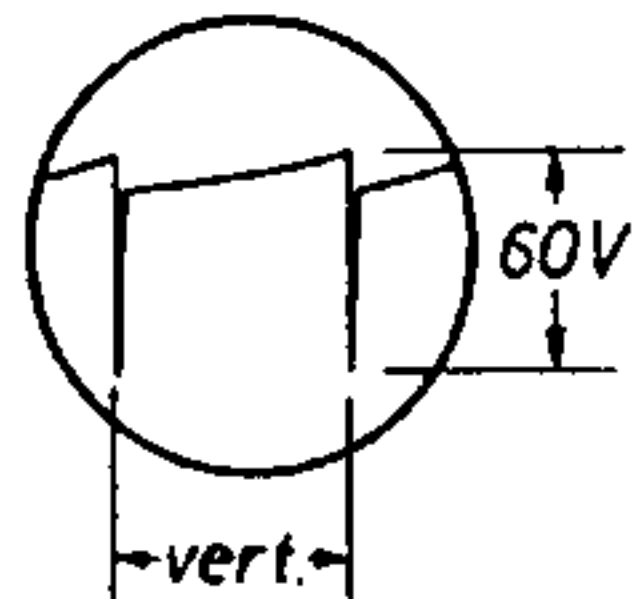

14

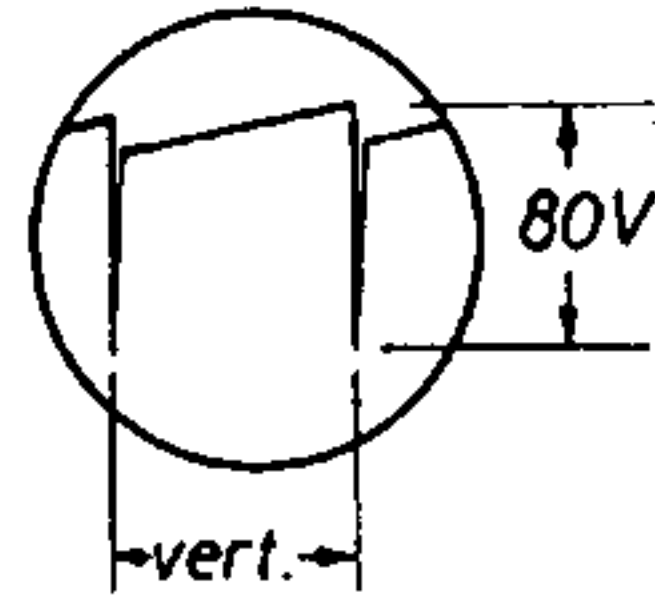

15