

UL41

UABC80

UF41

UF85

UCH81

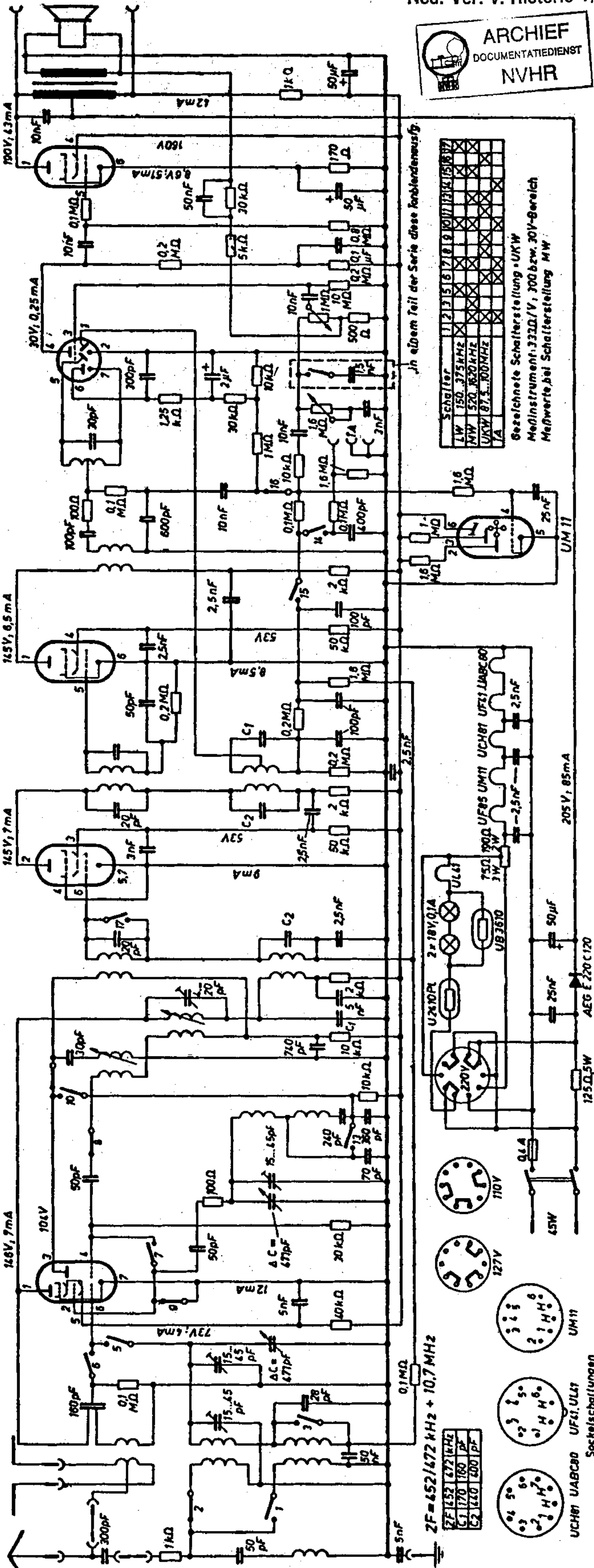

in einem Teil der Serie diese Kondensensufg.

Schaltler	1	2	3	4	5	6	7	8	9	10	11	12	13	14	15	16	17
LW	150	375	kHZ														
MW	520	1620	kHZ														
UKW	87.5	100	MHZ														
TA																	

Bezeichnete Schalterstellung - UKW
 Meßinstrument: 33Ω/V, 300 bzw. 30V-Bereich
 Meßwerte bei Schalterstellung MW

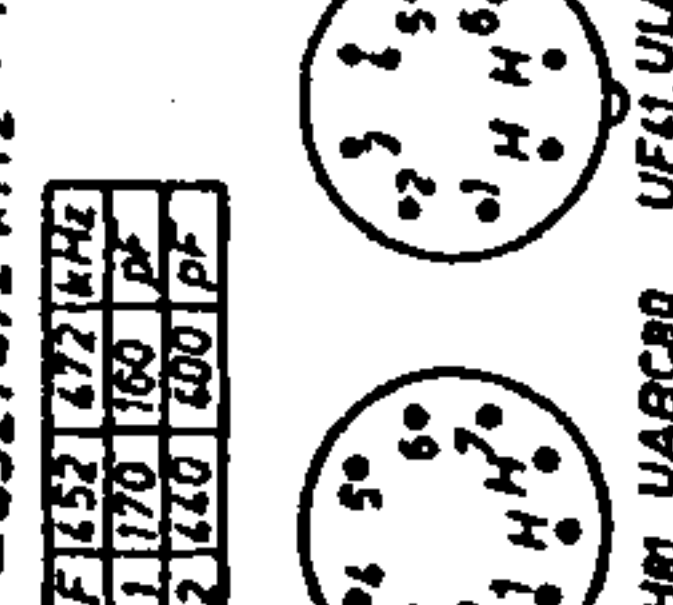
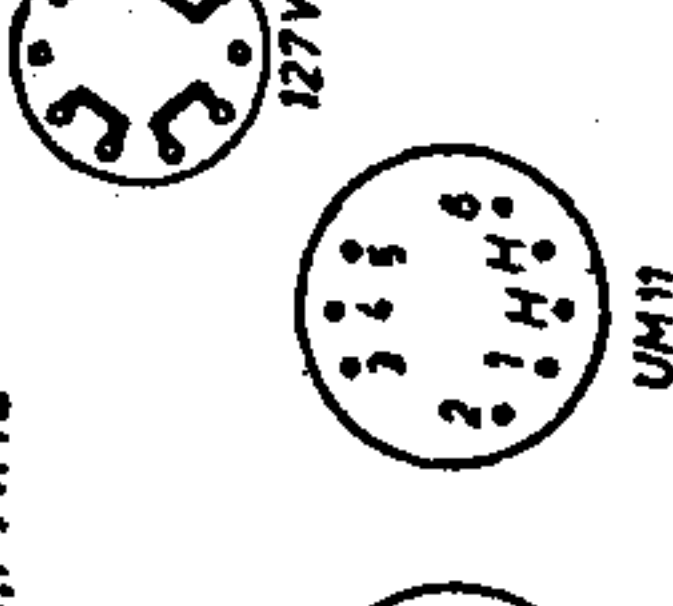
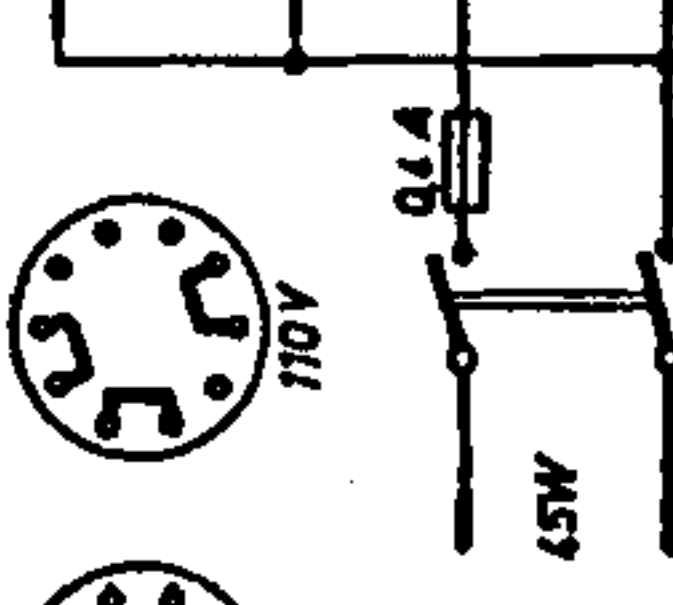
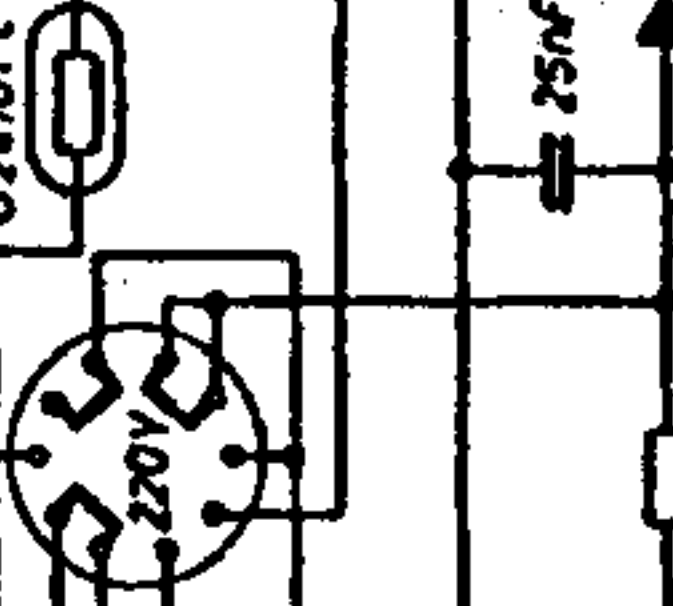
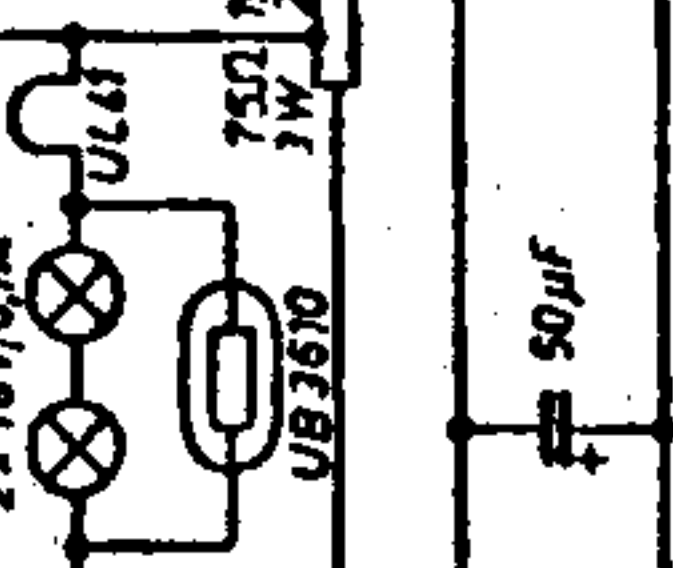
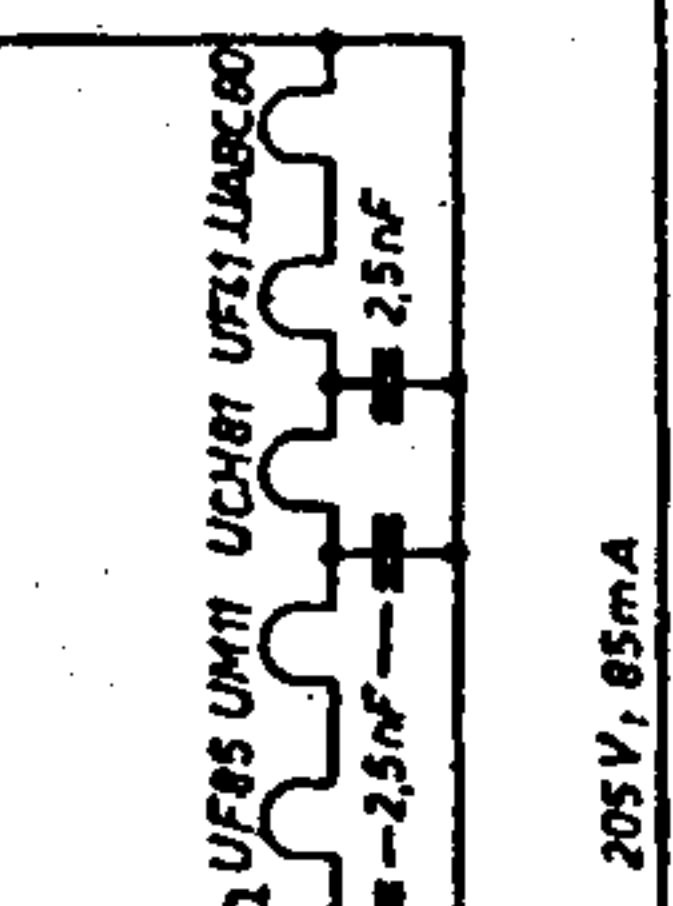
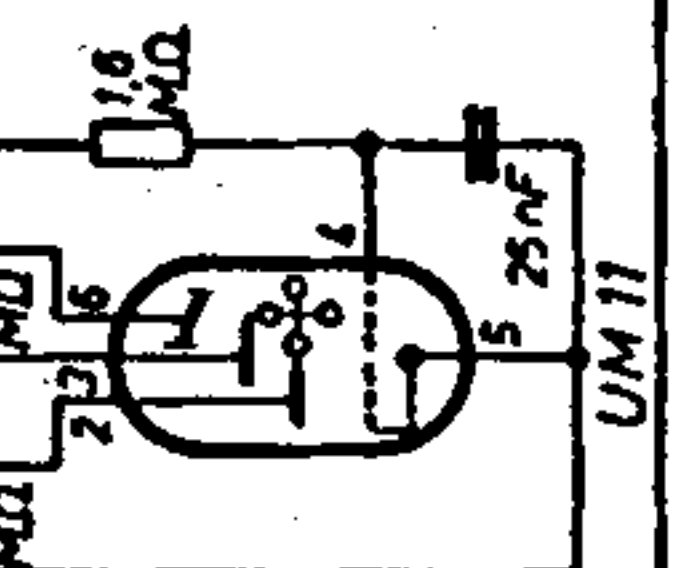

ZF = 652/672 kHz + 10.7 MHz

ZF	652	672	kHZ
C1	170	160	pF
C2	420	400	pF

UCH81 UABC80 UF41 UL41
 Sockelschaltungen